

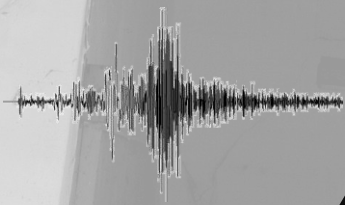

FASTENING TECHNOLOGY MANUAL

Seismic Design for concrete anchors

03/2017



Foreword

Dear customer,

As it is our ambition to be the worldwide leader in fastening technology, we are continuously striving to provide you with state-of-the-art technical information reflecting the latest developments in codes, regulations and approvals and technical information for our products.

The Fastening Technology Manuals for Post-Installed Anchors and for Anchor Channel reflect our ongoing investment into long term research and development of leading fastening products.

This Fastening Technology Manual -- seismic design for concrete anchors should be a valuable support tool for you when solving fastening tasks with Post-Installed Anchors under seismic conditions. It should provide you with profound technical know-how, and help you to be more productive in your daily work without any compromise regarding reliability and safety.

As we strive to be a reliable partner for you, we would very much appreciate your feedback for improvements. We are available at any time to answer additional questions that even go beyond this content.

Raimund Zaggl

Business Unit Anchors



Important notices

1. Construction materials and conditions vary on different sites. If it is suspected that the base material has insufficient strength to achieve a suitable fastening, contact the Hilti Technical Advisory Service.
2. The information and recommendations given herein are based on the principles, formulae and safety factors set out in the Hilti technical instructions, the operating manuals, the setting instructions, the installation manuals and other data sheets that are believed to be correct at the time of writing. The data and values are based on the respective average values obtained from tests under laboratory or other controlled conditions. It is the user's responsibility to use the data given in the light of conditions on site and taking into account the intended use of the products concerned. The user has to check the listed prerequisites and criteria conform with the conditions actually existing on the job-site. Whilst Hilti can give general guidance and advice, the nature of Hilti products means that the ultimate responsibility for selecting the right product for a particular application must lie with the customer.
3. All products must be used, handled and applied strictly in accordance with all current instructions for use published by Hilti, i.e. technical instructions, operating manuals, setting instructions, installation manuals and others.
4. All products are supplied and advice is given subject to the Hilti terms of business.
5. Hilti's policy is one of continuous development. We therefore reserve the right to alter specifications, etc. without notice.
6. The given mean ultimate loads and characteristic data in the Anchor Fastening Technology Manual reflect actual test results and are thus valid only for the indicated test conditions. Due to variations in local base materials, on-site testing is required to determine performance at any specific site.
7. Hilti is not obligated for direct, indirect, incidental or consequential damages, losses or expenses in connection with, or by reason of, the use of, or inability to use the products for any purpose. Implied warranties of merchantability or fitness for a particular purpose are specially excluded.

Hilti Corporation
FL-9494 Schaan
Principality of Liechtenstein
www.hilti.com

Hilti = registered trademark of the Hilti Corporation, Schaan

**1 Anchor technology and design
for seismic conditions**

page 4

- 1.1 Anchor connections under seismic action
- 1.2 Seismic impact on anchor behaviour
- 1.3 Legal considerations
- 1.4 Anchor design for seismic action
- 1.5 Design Examples

**2 Anchor selector for seismic
conditions**

page 24

3 Mechanical anchors

page 30

4 Chemical anchors

page 76

1.1 Anchor connections under seismic action

General

All fastenings in structures situated in seismically active areas may be subjected to seismic action no matter whether structural or non-structural components are concerned. These structural or non-structural connections are vital to ensure that the structure responds to a seismic event in a proper and predictable manner by means of anchor resistance and anchor displacement.

These components may not only have a direct impact on the safety of human beings, but also on proper functioning of the structure and therefore on possible loss of serviceability or efficiency during and after a seismic event.

Research indicates that the greatest repair costs resulting from a seismic event in most commercial buildings are not due to the damage to structural components alone but also to damage to non-structural systems (Figure 1). In addition, many of these non-structural systems are directly relevant to human life, especially those that must remain functional after an earthquake, such as hospitals or fire extinguishing systems.

Proper specifications and designs in combination with anchors approved for seismic applications, taking account of the relevant design parameters, are the best way to ensure that the damage resulting from a seismic event is minimized. On the following page we provide examples of typical applications in which seismic design may be perfectly feasible.

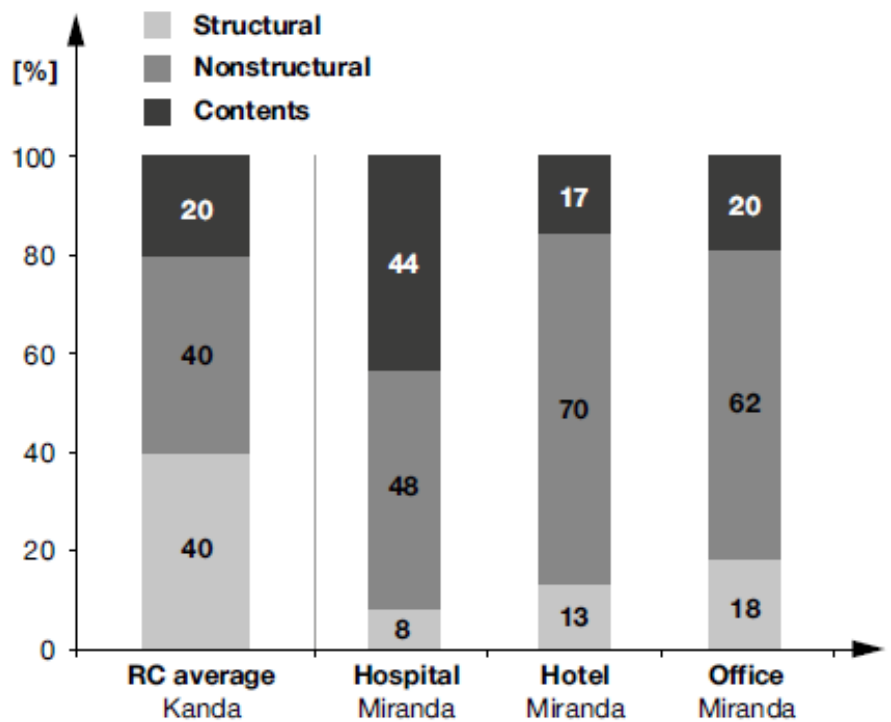

Figure 1- Repair cost resulting from a seismic event:

Source: Taghavi S. and Miranda E.: "Seismic Performance and Loss Assessment of Nonstructural Building Components," *Proceedings of 7th National Conference on Earthquake Engineering, Boston, 2002.*

Typical applications with anchor connections designed for seismic actions

All fastenings for primary structural members in buildings within active earthquake zones.



Figure 2

Fastenings of critical equipment and corresponding substructure; such as electricity generators and transformers, gas lines, etc.)



Figure 3



Figure 4

All fastenings in hospitals, schools and other structures that are generally used as shelters after catastrophic events



Figure 5

Fastenings for non-structural but directly safety-relevant components such as facades, skylight windows, etc.



Figure 6

1.2 Seismic impact on anchor behaviour

Seismic loads

Ground movement during an earthquake leads to relative displacement of a building's foundation. Owing to the inertia of its mass, the building cannot or is unable to follow this movement without deformation. Due to the stiffness of the structure, restoring forces result and vibration is induced. This leads to strain on the structure and, as a result of the stresses acting within it, also strain on the anchors connected to the structure. The loads acting on these anchors can be calculated directly on the basis of the characteristics of the building, its seismicity and the type of items fastened to the building's components.

In general terms, the main difference between seismic loading and static loading acting on anchors is the multi-directional loading induced by the seismic event (load cycling) as shown in Figure 7.

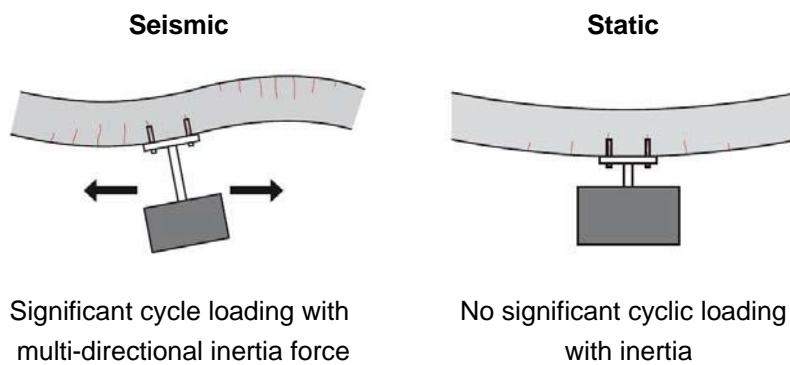

Figure 7 - Comparison of loading characteristics under seismic and static conditions

In addition, loading frequencies during earthquakes often lead to resonance phenomena which result in greater vibration amplitudes on the upper floors than on lower floors. This may result in a need for different designs for anchor systems situated at different levels of the building, even if used for the same application.

Behaviour of the materials in which anchors are set

Due to the multiple responses of seismic action, the assumed compression zone under static action may suddenly become the tension zone. The possibility of cracks intersecting the anchor location can therefore be assumed to be highly probable, even if the original anchoring location was assumed to be uncracked, as indicated.

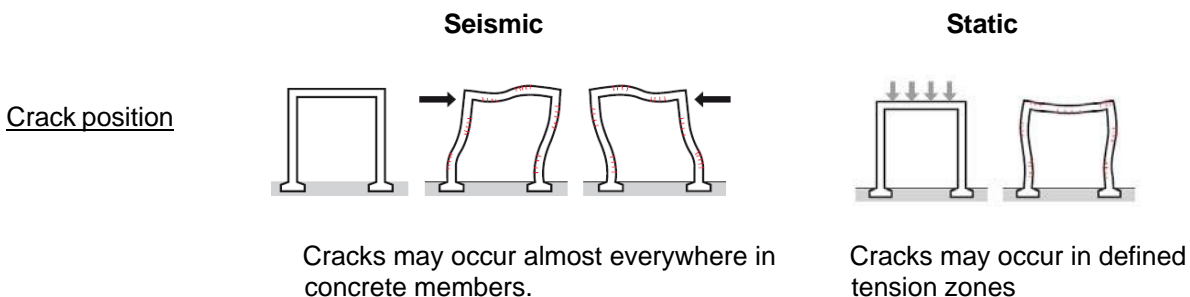
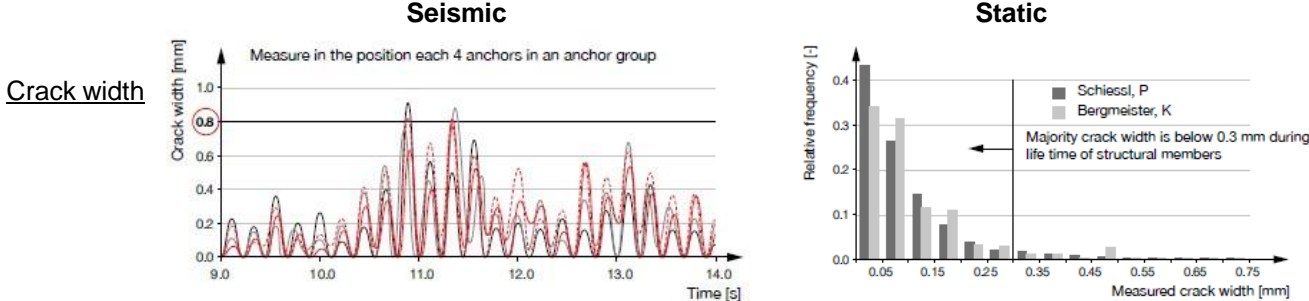

Figure 8- Comparison of potential crack positions under seismic and static conditions

The width of cracks generated during earthquakes is, on average, significantly greater than those resulting from static loading. Under static conditions, cracks are normally restricted to a width of 0.3 mm under service load conditions, and at the load levels of designed resistance they may reach a width of up to 0.5 mm. However, during seismic events, cracks can easily reach a width of up to 0.8 mm. This has been confirmed by tests with groups of 4 anchors carried out in 2006, as shown in Figure 9.



Source: Hoehler, M. S. (2006) Behavior and testing of fastenings to concrete for use in seismic applications.

Source: Eligehausen, R.; Bozenhardt, A. (1989): Crack widths as measured in actual structures and conclusions for the testing of fastening elements.

Figure 9 - Comparison of crack width under seismic and static conditions

The movement of concrete components under seismic actions results in opening and closing of cracks in combination with load cycling on the anchor. This crack opening and closing pattern is different to the patterns found under static conditions, as described in Figure 10.

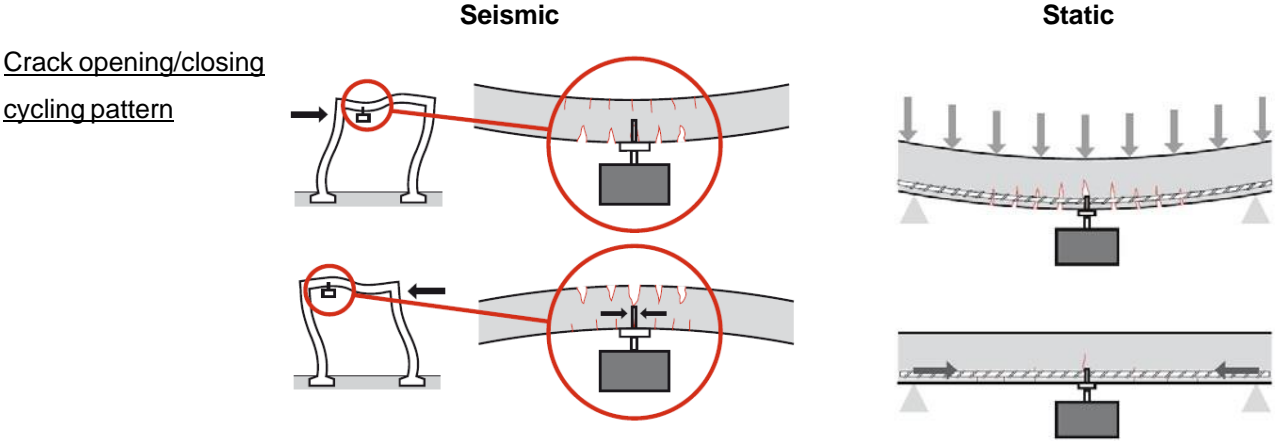

Concrete beside the cracks is alternately under compression and tension, resulting in the worst conditions for the anchor zone.

The crack opens and closes with the changing of live load and rebar restraint, which is less severe compared to seismic conditions

Figure 10 - Comparison of crack width under seismic and static conditions

Seismic events have a big impact on the loading and behavior of anchors in the supporting material, resulting in the possibility of some anchors being unsuitable for seismic conditions or having a lower capacity under seismic conditions than under static conditions.

Anchor resistance under seismic condition

Anchor resistance is characterized by various failure modes subdivided into concrete-related failure and steel-related failure modes, shown in Figure 11. The resistance of each failure mode must be taken into account in the design of fastening points.

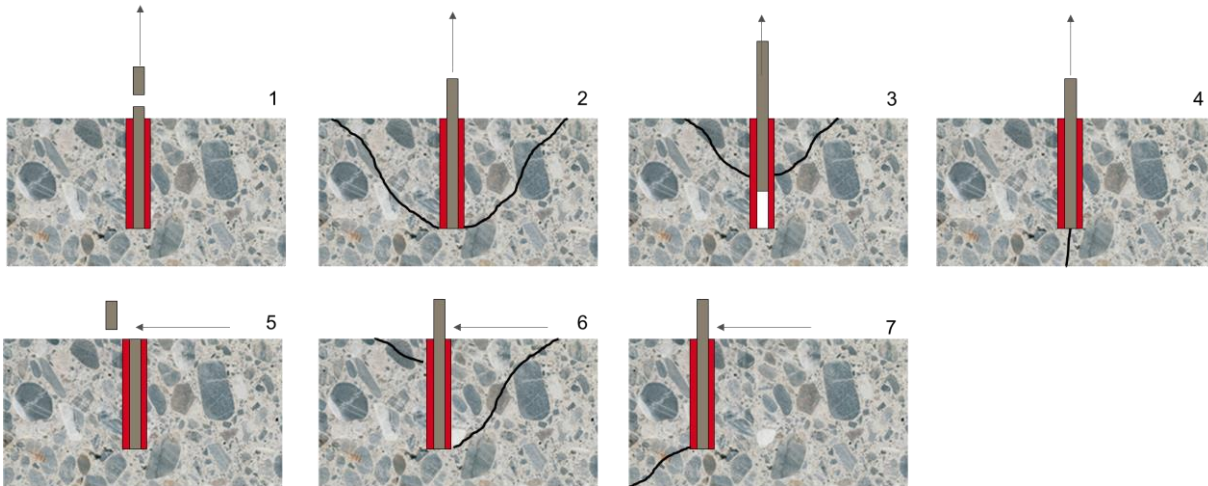

Figure 11 - Failure modes

Failure modes under tension:

(1) steel failure; (2) concrete cone; (3) Pull-out failure or combined pull-out and concrete cone failure; (4) concrete splitting failure

Failure modes under shear:

(5) steel failure; (6) concrete edge breakout failure; (6) pry-out failure

Under seismic conditions, due to cyclic loading on the anchor and the crack opening and closing pattern, the characteristic resistance of some failure modes may be significantly lower than those under static conditions. The reasons are listed in the following:

Steel failure resistance under seismic conditions

Due to the impact of cyclic loading, steel failure resistance under seismic conditions may be different to that under static conditions. Especially under shear loading, concrete spalling may occur on the surface of concrete members, resulting in increased lever arm.

Pull-out failure/ bond failure resistance

Pull-out failure and bond failure depends greatly on the design of the anchor itself. Some anchors may not hold any load at all during seismic events because they are pulled out due to cracks opening and closing during load cycling. These anchors may be expansion anchors with insufficient follow-up expansion, undercut anchors with insufficient bearing area, or bonded (chemical) anchors with insufficient bond strength after the formation of cracks.

Resistances of concrete cone failure, splitting failure, pry-out failure and edge failure.

Since concrete cone failure, splitting failure, pry-out failure and edge failure are relevant only to concrete itself, the basic characteristic values will be as same as in a static situation, but cracked concrete must be assumed.

1.3 Legal considerations

Overview of the European code system

Eurocode 1, Eurocode 2 and Eurocode 8 (EC1, EC2 and EC8) set the framework for the design of concrete structures, while European Technical Approval Guidelines (ETAGs) set out the basic requirements for the qualification and design of anchor fastenings.

For seismic conditions, EC8 lays down the methods to be used for calculating seismic action, and the structural response to seismic action, while EC2 defines the design methods and resistances of concrete components. As for anchors, the design method is laid down by **EOTA TR045 Design of Metal Anchors For Use In Concrete Under Seismic Actions**, while the resistance is given in the **European Technical Assessment (previously European Technical Approval) for the specific product based on the European Technical Approval Guidelines (ETAGs), especially its Annex E: Assessment of Metal Anchors under Seismic Action**. The code system is also summarized in Figure 12.

This also shows that the necessity for qualification or assessment of anchor behavior is the key difference between structural member design and the anchor design code system.

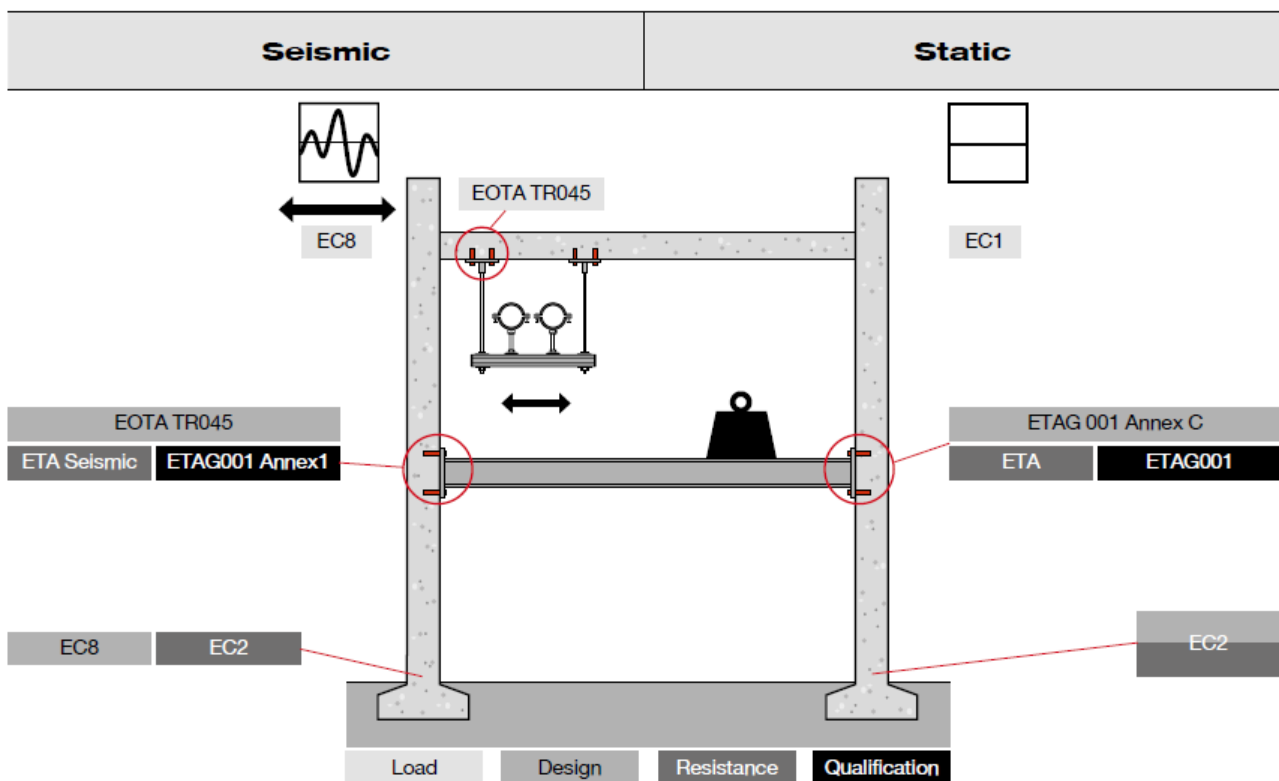

Figure 12 – Overview of the European code system for concrete and anchors

Assessing anchor performance under seismic conditions

The European Technical Approval Guidelines were developed prior to July 2013 for the assessment of products not covered by a harmonized standard.

The European Technical Approval Guideline **ETAG 001 “METAL ANCHORS FOR USE IN CONCRETE”** sets out the basis for the assessment of anchors to be used in concrete (cracked and non-cracked). It consists of:

- Part 1 Anchors in general
- Part 2 Torque-controlled expansion anchors
- Part 3 Undercut anchors
- Part 4 Deformation-controlled expansion anchors
- Part 5 Bonded anchors
- Part 6 Anchors for multiple use for non-structural applications

- Annex A Details of test
- Annex B Tests for admissible service conditions – detailed information
- Annex C Design methods for anchorages
- **Annex E Assessment of metal anchors under seismic**

Additional technical reports (TR) related to ETAG 001 set out additional requirements for the assessment of **special anchors** and/or provide a design method for their use in concrete:

- TR 018 Assessment of torque-controlled bonded anchors
- TR 020 Evaluation of anchorages in concrete concerning resistance to fire
- TR 029 Design of bonded anchors
- **TR 045 Design of metal anchors for use in concrete under seismic actions**

Anchors to be used in the seismic zone shall be evaluated in accordance with ETAG 001 Annex E and designed using the method provided in TR 045 in order to achieve the required safety level.

European Assessment Documents (from 1st of July 2013)

European Assessment Documents (EADs) are harmonized technical specifications, applicable as of 1st of July 2013 within the framework of the new Construction Products Regulations (EU/305/2011), developed by the European Organization for Technical Assessment (EOTA).

The EADs contribute to the safe assessment of construction products, enable manufacturers to comply with European legislation, facilitate the uptake of innovation, research and technical development, and promote the interoperability of products and sustainability. The EADs contain the following information:

- General information, scope and use of the products
- Essential characteristics of the products
- Method of assessment of the performance of the products
- Reference to the Assessment and Verification of Constancy of Performance (AVCP)
- Assumptions applicable to the assessment of performance
- Identification of the product
- Reference documents such as other EADs, standards, technical reports, etc.
- Product-related example for a Declaration of Performance (DoP)

No new ETAGs will be developed as of 1st of July 2013. However, the **existing ETAGs can be used as EADs until they are transferred into new EADs.**

European Technical Assessment (previously European Technical Approval)

According to the new Construction Products Regulations (EU/305/2011), the European Technical Assessment (ETA) is a document that provides information on the assessment of the performance of product regarding its essential characteristics. An ETA is issued by a Technical Assessment Body (TAB) upon request by a manufacturer and is the basis for a Declaration of Performance (DoP) which, in turn, is required for affixing the CE marking on the product.

Current ETAs issued after 1st of July 2013 are valid for an indeterminate period and contain the following information:

- General information on the manufacturer and the product type
- Description of the product and its intended use
- Performance of the product and references to the methods used for its assessment
- Assessment and Verification of Constancy of Performance systems (AVCP) applied
- Technical details necessary for the implementation of the AVCP

ETAs which were issued up to 30 June 2013, known as European Technical Approvals and based on ETAGs, remain valid until the end of their validity period.

Declaration of performance (DoP)

The DoP is prepared by the manufacturer and presents information about the performance of the product in relation to the essential characteristics. In drawing up the DoP, the manufacturer assumes responsibility for the conformity of the construction product with the declared performance.

Assessment and Verification of Constancy of Performance (AVCP)

In order to ensure that the declaration of performance (DoP) for specific products is accurate and reliable, the performance of the construction products shall be assessed and their production in the factory shall be controlled to ensure that the products will continue to have the same performance.

This is achieved by applying a system of Assessment and Verification of Constancy of Performance (AVCP) for each family of construction product, for which several tasks have to be undertaken (e.g. for System 1+ and 1):

For the manufacturer:

- Factory production control (permanent internal control of production and documentation according to a prescribed test plan)
- Involvement of a body that is notified for the tasks

The notified product certification body decides on the issuing, restriction, suspension or withdrawal of the certificate of constancy of performance of the product on the basis of the outcome of the following assessments and verification carried out by the body:

- Assessment of the performance of the product
- Initial inspection of the manufacturing plant and of factory production control
- Continuing surveillance, assessment and evaluation of factory production control

1.4 Anchor design for seismic action

Seismic performance categories C1 and C2

Both ETAG 001 Annex E and EOTA TR045 classify anchors suitable for use under seismic conditions in two categories: C1 and C2. According to these guidelines, anchors without approval for seismic applications should be used only in low seismicity areas, while most seismic areas require use of anchors of the seismic performance category C2. Seismic C1 can also be used when the application is confirmed to be a non-structural element without any safety relevance. These requirements are summarized in Table 1, and seismicity in Europe is shown in Figure 13.

$a_g \times s$	Structural applications		Non-structural applications	
	Building IV	Building II, III	Building IV	Building II, III
0.05 - 0.1 g	ETA C2		ETA C1	
> 0.1 g	ETA C2			

Table 1 - European seismic category for anchors

However, selecting an anchor of the appropriate seismic performance category is not enough to guarantee safety under seismic conditions, because the resistance of anchors, even those in the same category, can vary greatly. Thorough calculation of the resistance is still necessary in order to guarantee the safety of the anchorage.

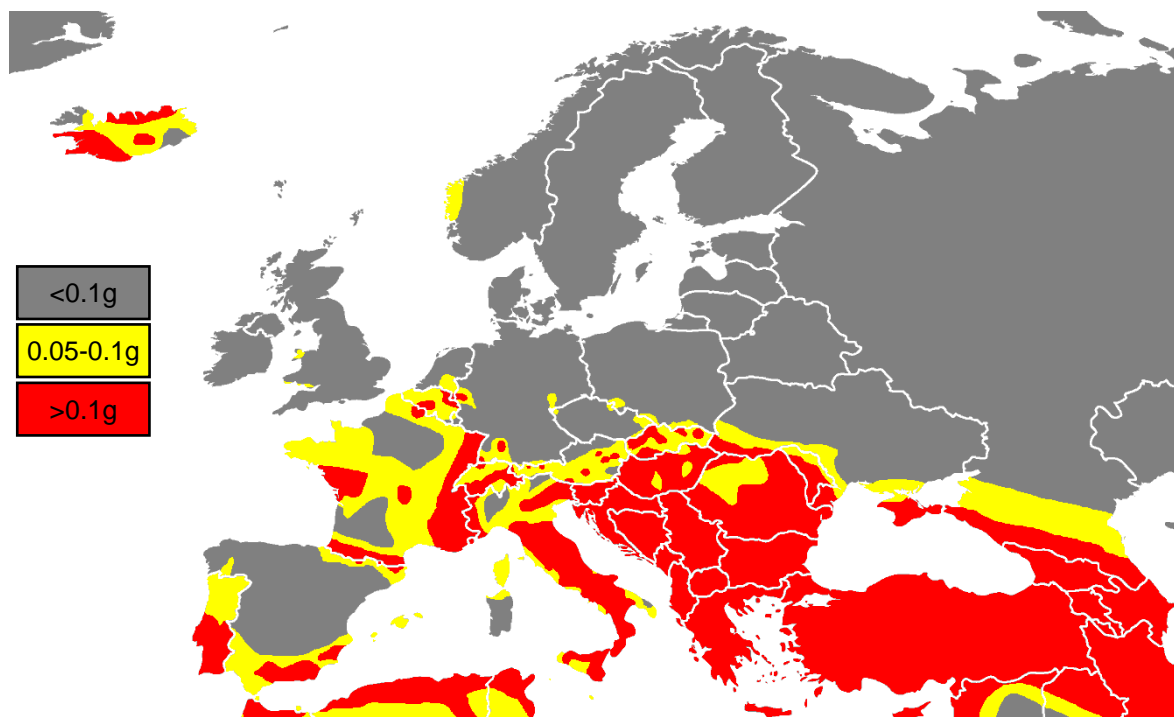
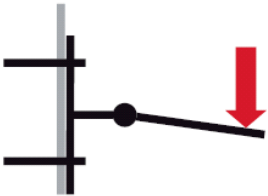

Figure 13 – Map showing European seismicity

Design options for base plates to be used under seismic conditions

Ductile failure is often a requirement in seismic design for structural elements. The situation is similar for anchors, although brittle failure is still allowed when the corresponding measurements are taken into account. In EOTA TR045, three design conceptual options are given for a base plate design, as follows:

Capacity design (ductile failure)



The anchor must resist the load corresponding to the capacity of the attached elements or fixture.

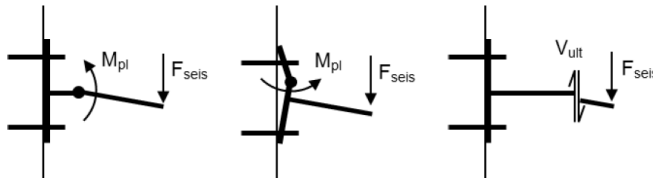

In this case, the load used to design the anchor shall result from the resistance of the attached elements or fixture. However, it is normally very difficult to find the most critical load combination for the anchor group based on the selected elements. It is also not easy to determine the load at which the fixture will yield. This option is therefore most often used in applications where a weak point such as a hinge or rubber is present, the resistance of which can be easily obtained.

Elastic design (brittle failure)

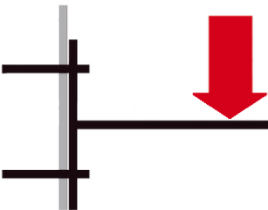

Elastic design is the only approach that can allow brittle failure in seismic design for base plates. When choosing this option, behavior factor q (explained in Eurocode 8) must be 1.0 in order to assume non-energy dissipation for the whole structural system, and every component must be capable of maintaining elasticity under seismic actions. For special non-structural applications where factor q is already 1.0, the load used for designing anchors must still be multiplied by 1.5.

Ductile anchor (ductile failure)



In this case, anchors with C2 approval must be used, and steel failure design resistance must be the lowest value.

Moreover, the ductility requirements such as material elongation, reduction of area and the free length equal to 8 times anchor diameter must allow adequate stretch length. This free stretch length can be achieved by levelled-up tightening, de-bonding the upper part of chemical anchor embedment depth, and use of deeply embedded chemical anchors.

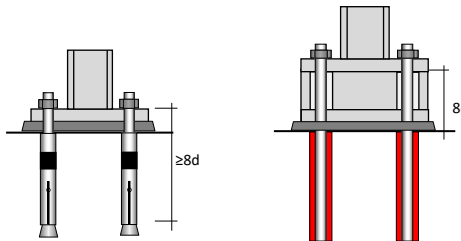

Due to the complexity of defining loads for capacity design and the extreme difficulty of achieving ductile anchor failure in the application, the elastic design approach is often used for base plate application design.

Taking the impact of displacement into account in the application

There are many cases, such as seismic isolation or damping systems, in which rigid connection can only function properly if displacement of the anchored part is limited. In these cases, displacement has to be taken into account during design.

As the displacement evaluation method is given only for the evaluation of anchors of the seismic performance category C2 in ETAG 001 Annex E, it is therefore recommended that anchors of the C2 category are used for such applications.

If the anchor displacements $\delta_{N,seis(DLS)}$ under tensile loading and/or $\delta_{V,seis(DLS)}$ under shear loading provided in the relevant ETA (for anchors qualified for seismic performance category C2) are higher than the corresponding required values $\delta_{N,req(DLS)}$ and/or $\delta_{V,seis(DLS)}$ higher than the required displacement, the design resistance may be reduced proportionally as shown in the following equations to meet the required displacement limits.

$$N_{Rd,seis,reduced} = N_{Rd,seis} \cdot \frac{\delta_{N,req(DLS)}}{\delta_{N,seis(DLS)}}$$

$$V_{Rd,seis,reduced} = V_{Rd,seis} \cdot \frac{\delta_{V,req(DLS)}}{\delta_{V,seis(DLS)}}$$

Seismic reduction factor for anchor design resistance under seismic conditions

In addition to all the safety factors and influencing factors that need to be taken into account under static conditions, the reduction factor α_{seis} must also be applied under seismic conditions. The value of this factor is given by EOTA TR045, and is also listed here in Table 2 for Hilti seismic anchors.

Loading	Failure mode	Single anchor	Anchor group
Tension	Steel failure	1.0	1.0
	Pull-out failure		
	Combined pull-out and concrete failure	1.0	0.85
	Concrete cone failure (HDA)	1.0	0.85
	Concrete cone failure (other anchors)	0.85	0.75
	Splitting failure	1.0	0.85
Shear	Steel failure	1.0	0.85
	Concrete edge failure	1.0	0.85
	Concrete pry out failure (HDA)	1.0	0.85
	Concrete pry out failure (other anchors)	0.85	0.75

Table 2 - Reduction factor α_{seis}

Influence of an annular gap on anchorage resistance under shear loading

An Annular gap influences the anchor's resistance

Under shear loading, if the force exceeds the friction between the concrete and the anchoring plate, the consequence will be displacement of the fixture by an amount equal to the size of the annular gap. Forces acting on the anchors are amplified due to the impact effect on the anchor resulting from the sudden stop against the side of the hole (Figure 14). In this case, a factor α_{gap} equal to 0.5 must be applied for the shear resistance of the anchor system.

By eliminating the annular gap, e.g. by filling the clearance hole with an adhesive mortar, the effects described above can be controlled, with great benefit to the performance of the anchorage.

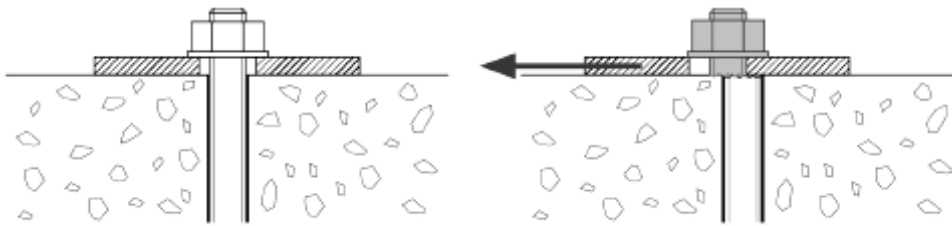

Figure 14 – The possible consequence of an annular gap

Recommended the use of Hilti Seismic Set

In accordance with the European seismic design guidelines, an annular gap between an anchor and its fixture should be avoided in seismic design situations. Moreover, loosening of the nut must be prevented by application of appropriate measures. Use of the Hilti Seismic Set (Figure 15) ensures a professional approach that allows controlled filling of annular gaps as well as prevention of loosening of the nut as the set also includes a lock nut.

According to the European guideline, filling the hole clearance between the anchor and the fixture using the Hilti Seismic set can increase the factor α_{gap} from 0.5 to 1.0.

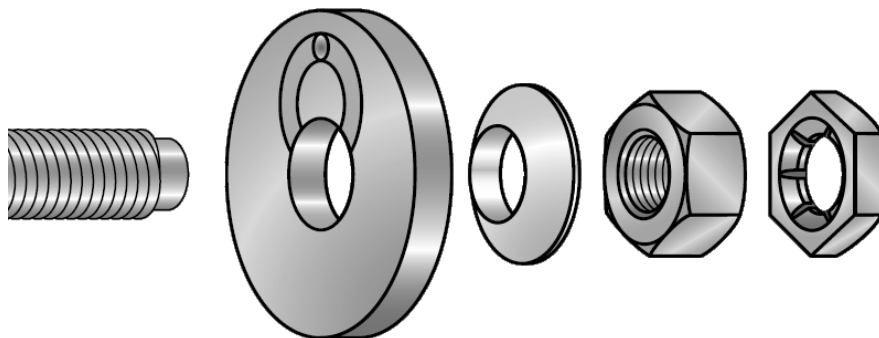

Figure 15 – Hilti Seismic Set comprising filling washer, conical washer, nut and lock-nut

Restrictions applicable to anchor design in seismic zone

Plastic hinging area

Since seismic events represent extreme conditions for structures in general, some cases are not covered by current codes.

Parts of structures may be subjected to extreme inelastic deformation as illustrated in Figure 16. In the reinforced areas, yielding of the reinforcement and cycling of cracks may result in crack widths of several millimeters, particularly in areas subject to plastic hinging. Qualification procedures for anchors do not currently anticipate such large crack widths. For this reason, anchorages in areas where plastic hinging is expected to occur, such as at the base of shear walls and the joint zones of frames, should be avoided unless appropriate design measures are implemented.

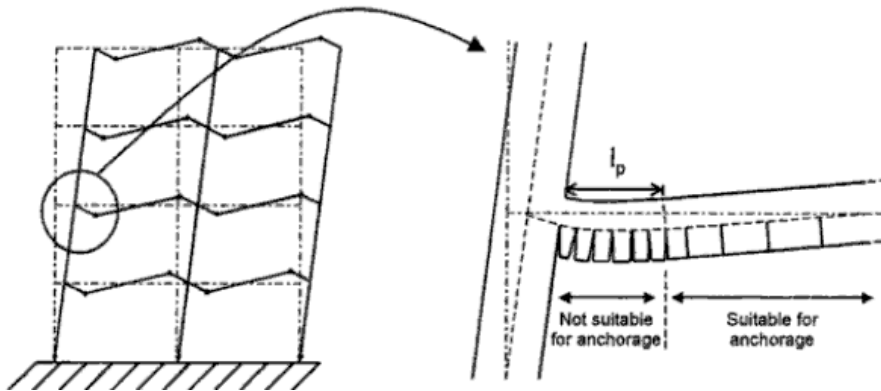

Figure 16 – Member cracking, assuming a strong column, weak girder design

Stand-off application and anchor groups more than 4 anchors

Due to the complexity of seismic actions, design methods for cases where a base plate with more than 4 anchors is close to an edge or where anchors are levelled up are not covered by the current scope of building codes.

Hilti SOFA seismic design method

As anchor resistance under seismic conditions is normally much lower than under static conditions, more than 4 anchors are required in many situations in order to fulfil the loading requirements, especially where the base plate is close to an edge.

With a view to providing a solution in such cases, the Hilti SOFA seismic design method has been developed, based on extensive research test results using Hilti anchors suitable for the seismic performance category C2.

The illustrations below provide an overview of the scope of the layouts in EOTA TR045 and the SOFA seismic design method.

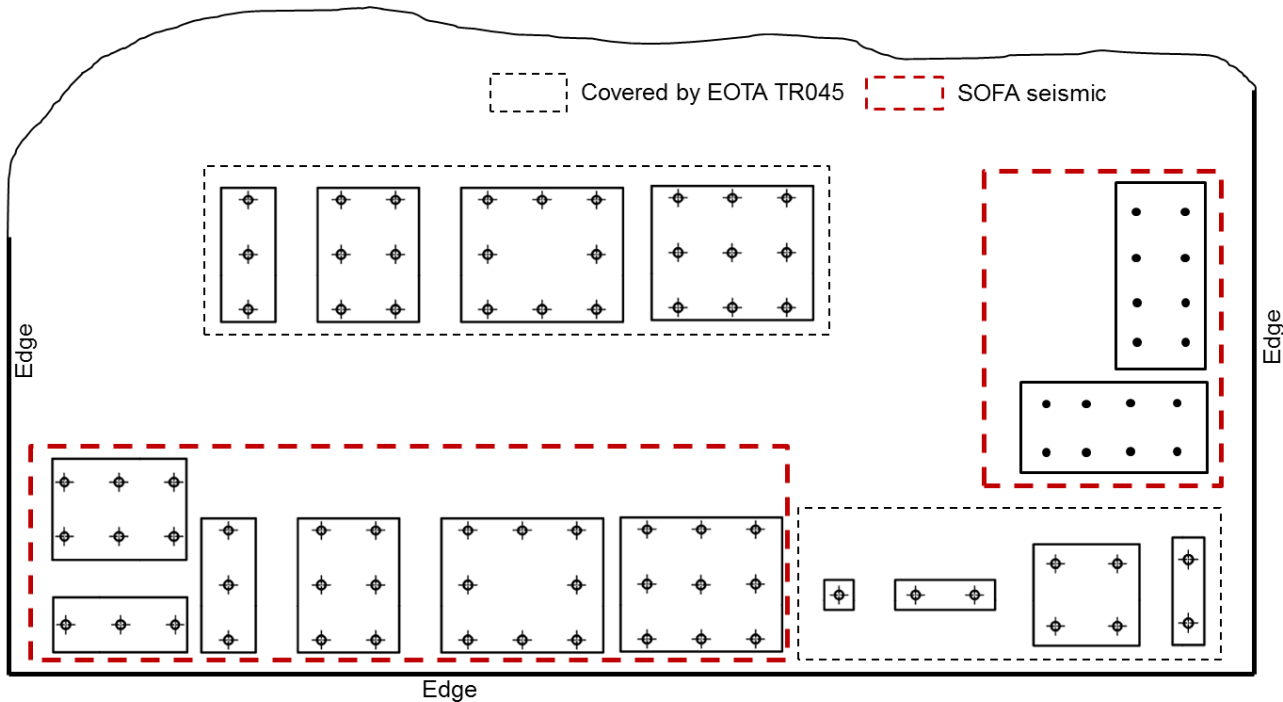

Figure 17 – Anchor configuration scope covered by Hilti SOFA under static condition

Hilti PROFIS Anchor design software

Hilti PROFIS Anchor design software provides customized fastening solutions for more complex situations and accurate design in accordance with international and national guidelines and for applications that go beyond the scope of the guidelines, e.g. a group of anchors with more than four anchors close to an edge or more than eight anchors far away from an edge. The results obtained may differ from calculations made in accordance with this manual.

The following methods can be used for seismic design with Hilti PROFIS Anchor:

- EOTA TR045
- CEN/TS
- ACI 318
- CSA (Canadian standard)
- SOFA (Hilti Solution for Fastening, Hilti internal design method based on EOTA TR045)

1.5 Design Example

Fastening point information

Concrete	Cracked concrete C50/60, with enough rebar inside to avoid concrete splitting failure.	
Anchor	HIT-HY 200A + HIT-Z M12 + Hilti filling set	
Service temperature range of base material	Temperature range I (-40°C - +40°C)	
Number of anchors	Group of two anchors close to the edge	
General load condition	No eccentricity, shear load direction perpendicular to free edge. Condition requires anchor with seismic performance category C2	
Base material thickness	h	150mm
Anchor spacing	s	150mm
Edge distance	c	100mm
Effective anchorage depth (with $h_{nom}=h_{nom,min}=60$ mm)	h_{ef}	60 mm
TENSION design action (fixing point) static condition	N_{Sd}	18 kN
SHEAR design action (fixing point) static condition	V_{Sd}	12 kN
TENSION design action (fixing point) Seismic condition	N_{Sd}	12 kN
SHEAR design action (fixing point) Seismic condition	V_{Sd}	6 kN

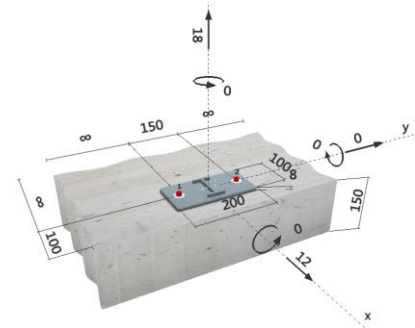

Static condition

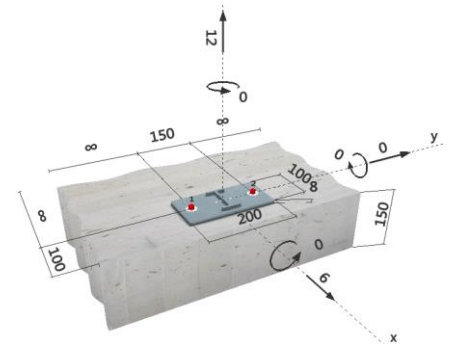

Seismic condition

Static design condition

Tension resistance

Static design steel resistance		
Static resistance	$N_{Rd,s}$	36,7 kN

Static design combined pull-out and concrete cone resistance						
Basic static resistance					$N^0_{Rd,p}$	33,1 kN
$s_{cr,Np} =$	180 mm	$A^0_{c,N} =$	32,400 mm ²		$\frac{A_{c,N}}{A^0_{c,N}}$	1,83
$c =$	100 mm	$s =$	150 mm	$A_{c,N} =$	59,400 mm ²	
$c_{cr,Np} =$	90 mm				$\Psi_{s,Np}$	1,00
$h_{ef} =$	60 mm				$\Psi_{re,Np}$	1,00
$e_v =$	0 mm				$\Psi_{ec,Np}$	1,00
$n =$	2	$k =$	2,3		$\Psi_{g,Np}$	1,00
$d =$	12 mm	$T_{Rk} =$	22 N/mm ²			
					$N_{Rd,p} = N^0_{Rd,p} \frac{A_{c,N}}{A^0_{c,N}} \Psi_{s,Np} \Psi_{re,Np} \Psi_{ec,Np} \Psi_{g,Np}$	60,8 kN

Static design concrete cone resistance						
Basic static resistance					$N^0_{Rd,c}$	17,3 kN
$s_{cr,N} =$	180 mm	$A^0_{c,N} =$	32,400 mm ²		$\frac{A_{c,N}}{A^0_{c,N}}$	1,83
$c =$	100 mm	$s =$	150 mm	$A_{c,N} =$	59,400 mm ²	
$c_{cr,N} =$	90 mm				$\Psi_{s,N}$	1,00
$h_{ef} =$	60 mm				$\Psi_{re,N}$	1,00
$e_v =$	0 mm				$\Psi_{ec,N}$	1,00
					$N_{Rd,c} = N^0_{Rd,c} \frac{A_{c,N}}{A^0_{c,N}} \Psi_{s,N} \Psi_{re,N} \Psi_{ec,N}$	31,7 kN

Tension design resistance: lowest value	$N_{Rd,c} =$	31,7 kN
---	--------------	----------------

Shear resistance

Static design steel resistance						
Static resistance					$V_{Rd,s}$	21,6 kN
Static design concrete pry-out resistance						
Static design concrete cone resistance					$N_{Rd,c}^0$	17,3 kN
$s_{cr,V} =$	180 mm	$A_{c,V}^0 =$	32,400 mm ²		$\frac{A_{c,N}}{A_{c,N}^0}$	1,83
$c =$	100 mm	$s =$	150 mm	$A_{c,V} =$	59,400 mm ²	
$c_{cr,V} =$	90 mm				$\Psi_{s,V}$	1,00
$h_{ef} =$	60 mm				$\Psi_{re,V}$	1,00
$e_v =$	0 mm				$\Psi_{ec,V}$	1,00
					α_{seis}	0,75
					k	2,00
					$N_{Rd,c} = N_{Rd,c}^0 \frac{A_{c,N}}{A_{c,N}^0} \Psi_{s,N} \Psi_{re,N} \Psi_{ec,N}$	31,7 kN
					$V_{Rd,cp} = k \cdot N_{Rd,c}$	63,4 kN

Static design concrete edge resistance						
Basic static resistance					$V_{Rd,c}^0$	13,9 kN
$k_1 =$	1,70	$h_{ef} =$	60 mm	$d_{nom} =$	12 mm	$\frac{A_{c,V}}{A_{c,V}^0}$
$s_{cr,V} =$	180 mm	$A_{c,V}^0 =$	45,000 mm ²	$A_{c,V} =$	67,500 mm ²	
$c =$	100 mm	$s =$	150 mm			$\Psi_{s,V}$
$c_{cr,V} =$	90 mm				$\Psi_{re,V}$	1,00
$h_{ef} =$	60 mm				$\Psi_{ec,V}$	1,00
$e_v =$	0 mm				$\Psi_{h,V}$	1,00
					$\Psi_{\alpha,V}$	1,00
					$V_{Rd,c} = V_{Rd,c}^0 \frac{A_{c,N}}{A_{c,N}^0} \Psi_{s,V} \Psi_{re,V} \Psi_{ec,V} \Psi_{\alpha,V}$	20,9 kN

Shear design resistance: lowest value	$V_{Rd,s} =$	20,9 kN
---------------------------------------	--------------	----------------

Combined tension and shear resistance

The following equation must be satisfied for combined tension and shear loads:

$$(Eq. 1) \quad (\beta_N)^{1,5} + (\beta_V)^{1,5} \leq 1$$

β_N (β_V): ratio between design action and design resistance for tension (shear) loading

$$N_{Sd} = 18 \text{ kN} \quad \beta_N = N_{Sd,1}/N_{Rd} = 0,568 \leq 1$$

$$V_{Sd} = 12 \text{ kN} \quad \beta_V = V_{Sd,1}/V_{Rd} = 0,575 \leq 1$$

$$N_{Rd} = 31,7 \text{ kN} \quad (\beta_N)^{1,5} + (\beta_V)^{1,5} = 0,87 \leq 1$$

$$V_{Rd} = 20,9 \text{ kN}$$

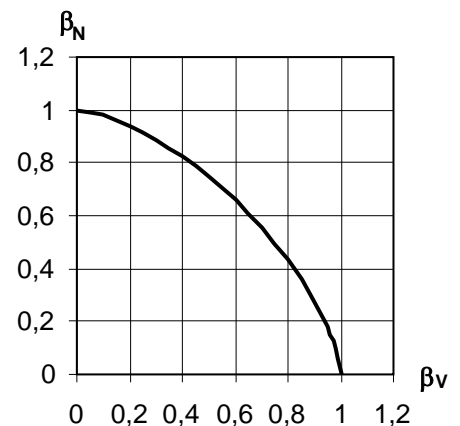

Seismic design condition (seismic performance category C2)

Tension resistance

Seismic design steel resistance			
Static resistance		$N_{Rd,s}$	36,7 kN
		α_{seis}	1,00
		$N_{Rd,s,seis} = N_{Rd,s} \alpha_{seis}$	36,7 kN

Seismic design combined pull-out and concrete cone resistance						
Basic static resistance					$N^0_{Rd,p}$	19,6 kN
$s_{cr,Np} =$	180 mm	$A^0_{c,N} =$	32,400 mm ²		$\frac{A_{c,N}}{A^0_{c,N}}$	1,83
$c =$	100 mm	$s =$	150 mm	$A_{c,N} =$	59400 mm ²	
$c_{cr,Np} =$	90 mm				$\Psi_{s,Np}$	1,00
$h_{ef} =$	60 mm				$\Psi_{re,Np}$	1,00
$e_v =$	0 mm				$\Psi_{ec,Np}$	1,00
					α_{seis}	0,85
					$N_{Rd,p,seis} = N^0_{Rd,p} \frac{A_{c,N}}{A^0_{c,N}} \Psi_{s,Np} \Psi_{re,Np} \Psi_{ec,Np} \alpha_{seis}$	30,6 kN

Seismic design concrete cone resistance						
Basic static resistance					$N^0_{Rd,c}$	17,3 kN
$s_{cr,N} =$	180 mm	$A^0_{c,N} =$	32400 mm ²		$\frac{A_{c,N}}{A^0_{c,N}}$	1,83
$c =$	100 mm	$s =$	150 mm	$A_{c,N} =$	59400 mm ²	
$c_{cr,N} =$	90 mm				$\Psi_{s,N}$	1,00
$h_{ef} =$	60 mm				$\Psi_{re,N}$	1,00
$e_v =$	0 mm				$\Psi_{ec,N}$	1,00
					α_{seis}	0,85
					$N_{Rd,c,seis} = N^0_{Rd,c} \frac{A_{c,N}}{A^0_{c,N}} \Psi_{s,N} \Psi_{re,N} \Psi_{ec,N} \alpha_{seis}$	23,8 kN

Tension design resistance: lowest value		$N_{Rd,c,seis} =$	23,8 kN
---	--	-------------------	----------------

Shear resistance

Seismic design steel resistance		
Basic characteristic seismic resistance		$V_{Rd,seis,C2}$ 16,0 kN
Seismic factor		α_{seis} 0,85
		$V_{Rd,s,seis} = n V_{Rd,seis,c2} \alpha_{seis} \alpha_{gap}$ 27,2 kN

Seismic design concrete pry-out resistance							
Seismic design concrete cone resistance					$N_{Rd,c}^0$	19,6 kN	
$s_{cr,V} =$	180 mm	$A_{c,V}^0 =$	32,400 mm ²		$\frac{A_{c,V}}{A_{c,V}^0}$	1,83	
$c =$	100 mm	$s =$	150 mm	$A_{c,V} =$	59,400 mm ²		
$c_{cr,V} =$	90 mm					$\Psi_{s,V}$	1,00
$h_{ef} =$	60 mm					$\Psi_{re,V}$	1,00
$e_v =$	0 mm					$\Psi_{ec,V}$	1,00
						α_{seis}	0,75
						k	2,00
						$N_{Rd,c,seis} = N_{Rd,c}^0 \frac{A_{c,V}}{A_{c,V}^0} \Psi_{s,V} \Psi_{re,V} \Psi_{ec,V} \alpha_{seis}$	23,8 kN
						$V_{Rd,c,seis} = k \cdot N_{Rd,c,seis}$	47,5 kN

Seismic design concrete edge resistance							
Basic static resistance					$V_{Rd,c,seis}^0$	13,9 kN	
$k_1 =$	1,70	$h_{ef} =$	60 mm	$d_{nom} =$	12 mm	$\frac{A_{c,V}}{A_{c,V}^0}$	
$s_{cr,V} =$	180 mm	$A_{c,V}^0 =$	45,000 mm ²	$A_{c,V} =$	67,500 mm ²		
$c =$	100 mm	$s =$	150 mm			$\Psi_{s,V}$	
$c_{cr,V} =$	90 mm					$\Psi_{re,V}$	1,00
$h_{ef} =$	60 mm					$\Psi_{ec,V}$	1,00
$e_v =$	0 mm					$\Psi_{h,V}$	1,00
						$\Psi_{\alpha,V}$	1,00
						$V_{Rd,c,seis} = V_{Rd,c,seis}^0 \frac{A_{c,V}}{A_{c,V}^0} \Psi_{s,V} \Psi_{re,V} \Psi_{ec,V} \Psi_{\alpha,V} \alpha_{seis}$	17,7 kN

Shear design resistance: lowest value	$V_{Rd,s,seis} =$	17,7 kN
---------------------------------------	-------------------	---------

Combined tension and shear resistance

The following equation must be satisfied for combined tension and shear loads under seismic condition:

$$\beta_N \leq 1, \beta_V \leq 1, \text{ and } \beta_N + \beta_V \leq 1$$

$$N_{Sd} = 12 \text{ KN} \quad \beta_N = N_{Sd}/N_{Rd} = 0,505 \leq 1$$

$$V_{Sd} = 6 \text{ KN} \quad \beta_V = V_{Sd}/V_{Rd} = 0,338 \leq 1$$

$$N_{Rd} = 23,8 \text{ KN} \quad \beta_N + \beta_V = 0,843 \leq 1$$

$$V_{Rd} = 17,7 \text{ KN}$$

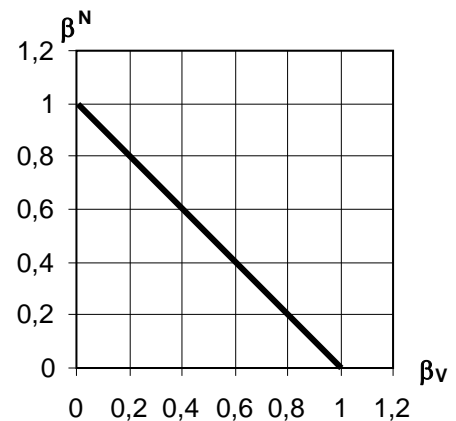

**1 Anchor technology and design
for seismic conditions**

page 4

**2 Anchor selector for seismic
conditions**

page 24

- 2.1 Mechanical anchors
- 2.2 Chemical anchors





3 Mechanical anchors

page 30

4 Chemical anchors





page 73

2.1 Mechanical anchors

Anchor type	Approvals						Advantages
	European Technical Approval	Seismic performance C1	Seismic performance C2	Fatigue approval / test report	Shock approval	Fire tested	
Undercut anchors							
 <p>HDA</p>	x	x	x	x	x	x	<ul style="list-style-type: none"> Automatic undercutting High load capacity Approved for all dynamic loads
 <p>HMU-PF</p>	x	x		x	x	x	<ul style="list-style-type: none"> Reliable mechanical interlock Easy verification of correct setting due to red setting mark
Expansion anchors							
 <p>HSL-3</p>	x	x	x	x	x	x	<ul style="list-style-type: none"> Integrated plastic section to telescope and pull down tightly The bolt can be re-torqued
 <p>HST3</p>	x	x	x		x	x	<ul style="list-style-type: none"> Quick and simple setting operation Setting mark Safety wedge for certain follow up expansion
Screw anchor							
 <p>HUS3</p>	x	x	x			x	<ul style="list-style-type: none"> Screw driven straight into base material Higher productivity Approval for reusability in fresh concrete

Anchor size qualified for seismic condition	Material Specification qualified for seismic condition						Setting		Page
	Steel, galvanised	Steel, sherardized, hot dipped galv.	Stainless steel A4 (1.4401)	HCR steel (1.4529)	External thread	Internal thread	Pre-setting	Through-fastening	
Anchor size: M10 – M20	x		x		x		x	x	30
Anchor size: M12 – M16		x			x		x		42
Anchor size: M10 – M20	x				x			x	48
Anchor size: M8 – M20	x		x		x		x	x	56
Anchor size: M8– M14	x							x	66

2.2 Chemical anchors

Anchor type	Approvals						Advantages
	European Technical Approval	Seismic performance C1	Seismic performance C2	Fatigue approval / test report	Shock approval	Fire tested	
HIT-HY 200-A (R) with HIT-Z 	x	x	x		x	x	<ul style="list-style-type: none"> ▪ No expansion pressure ▪ Flexibility in terms of working time ▪ No styrene content ▪ No plasticizer content ▪ Environmental protection due to the minimized packaging ▪ SafeSet with hollow drill bit and HIT-Z rod
HIT-HY 200-A with HIT-V 	x	x	x		x	x	<ul style="list-style-type: none"> ▪ No expansion pressure ▪ Flexibility in terms of working time ▪ No styrene content ▪ No plasticizer content ▪ Environmental protection due to the minimized packaging ▪ SafeSet with hollow drill bit
HIT-RE 500 V3 with HIT-V 	x	x	x			x	<ul style="list-style-type: none"> ▪ No expansion pressure ▪ Long working time ▪ SafeSet with hollow drill bit
HIT-RE 500 V3 with HIS-(R) N 	x	x				x	<ul style="list-style-type: none"> ▪ No expansion pressure ▪ Long working time ▪ SafeSet with hollow drill bit

Anchor size qualified for seismic condition	Material Specification qualified for seismic condition						Setting		Page
	Steel, galvanised	Steel, sheradised, hot dipped galv.	Stainless steel A4 (1.4401)	HCR steel (1.4529)	External thread	Internal thread	Pre-setting	Through-fastening	
HIT-Z M8 – M20	x		x		x		x	x	76
HIT-V M10 – M30	x	x	x	x	x	x	x	x	88
HIT-V M8 – M30	x	x	x	x	x		x	x	96
HIS- (R) N M8 - M20	x		x				x	x	108



**1 Anchor technology and design
for seismic conditions**

page 4

**2 Anchor selector for seismic
conditions**

page 24

3 Mechanical anchors

page 30

HDA Undercut anchor

HMU-PF Undercut anchor

HSL-3 Expansion anchor



HST3 Expansion anchor





HUS3 Screw anchor

4 Chemical anchor

page 74

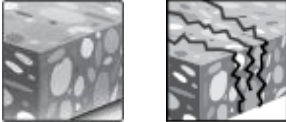
HDA Undercut anchor

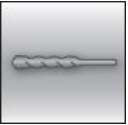
Anchor version	Benefits
 <p>HDA-P HDA-PR Anchor for pre-setting</p>	<ul style="list-style-type: none"> - safe and high performance structural seismic design with ETA C1 and C2 - mechanical interlock (undercut) - low expansion force (thus small edge distance / spacing) - self undercutting (without special undercutting tool) - performance of a headed stud - complete system (anchor, stop drill bit, setting tool, drill hammer) - setting mark on anchor for control (easy and safe) - completely removable
 <p>HDA-T HDA-TR Anchor for through-fastening</p>	

<p>Base material</p>  <p>Concrete (non-cracked) Concrete (cracked)</p>	<p>Load conditions</p>  <p>Static/quasi-static Seismic ETA-C1, C2 Fire resistance Fatigue Shock</p>
<p>Installation conditions</p>  <p>Hammer drilled holes</p>	<p>Other information</p>  <p>European Technical Assessment CE conformity PROFIS Anchor design Software Nuclear power plant approval</p>

Approvals / certificates

Description	Authority / Laboratory	No. / date of issue
European Technical Assessment ^{a)}	CSTB, Paris	ETA-99/0009 / 2015-01-06
ICC-ES report incl. seismic	ICC evaluation service	ESR 1546 / 2014-02-01
Shockproof fastenings in civil	Federal Office for Civil Protection,	BZS D 09-601/ 2009-10-21
Nuclear power plants	DIBt, Berlin	Z-21.1-1987 / 2014-07-22
Fatigue loading	DIBt, Berlin	Z-21.1-1693 / 2013-07-29
Fire test report	IBMB, Braunschweig	UB 3039/8151-CM / 2001-01-31

a) All data for HDA-P(R) and HDA-T(R) given in this section according ETA-99/0009, issue 2015-01-06. Sherardized versions HDA-PF and HDA-TF anchors are not covered by the approvals.

Seismic resistance

All data in this section applies to:

- Correct setting (See setting instruction with a drilling hammer)
- No edge distance and spacing influence
- *Steel* failure
- Minimum base material thickness
- Concrete C 20/25, $f_{ck,cube} = 25 \text{ N/mm}^2$
- $\alpha_{gap} = 1,0$ (using Hilti seismic filling set)

Effective anchorage depth for seismic C2 and C1

Anchor size	M10	M12	M16	M20
Eff. Anchorage depth h_{ef} [mm]	100	125	190	250

Characteristic resistance in case of seismic performance category C2

Anchor size		M10		M12			M16				M20					
Tension $N_{Rk,seis}$	HDA-P, HDA-T	25		35			75				95					
	HDA-PR, HDA-TR	25		35			75				-					
Shear	for t_{fix}	HDA-T	10≤	15≤	10≤	15≤	20≤	15≤	20≤	25≤	30≤	35≤	20≤	25≤	40≤	55≤
			<15	≤20	<15	<20	≤50	<20	<25	<30	<35	≤60	<25	<40	<55	≤100
	HDA-TR	10≤	15≤	10≤	15≤	20≤	30≤	15≤	20≤	25≤	35≤	-				
		<15	≤20	<15	<20	<30	≤50	<20	<25	<35	≤60	-				
$V_{Rk,seis}$	HDA-T	39	42	56	56	70	84	84	93	102	112	144	144	165	175	
		21,5	21,5	30,5	30,5	33,0	38,0	45,5	45,5	47,5	51	-				
		20		24			56				83					
		10,5		13,5			28,5				-					
$V_{Rk,seis}$	HDA-TR	20		24			56				83					
		10,5		13,5			28,5				-					
		20		24			56				83					
		10,5		13,5			28,5				-					
$V_{Rk,seis}$	HDA-P	20		24			56				83					
		10,5		13,5			28,5				-					
		20		24			56				83					
		10,5		13,5			28,5				-					
$V_{Rk,seis}$	HDA-PR	10,5		13,5			28,5				-					
		10,5		13,5			28,5				-					
		10,5		13,5			28,5				-					
		10,5		13,5			28,5				-					

Design resistance in case of seismic performance category C2

Anchor size		M10		M12			M16				M20					
Tension $N_{Rd,seis}$	HDA-P, HDA-T	16,7		23,3			50				63,3					
	HDA-PR, HDA-TR	16,7		23,3			50				-					
Shear	for t_{fix}	HDA-T	10≤	15≤	10≤	15≤	20≤	15≤	20≤	25≤	30≤	35≤	20≤	25≤	40≤	55≤
			<15	≤20	<15	<20	≤50	<20	<25	<30	<35	≤60	<25	<40	<55	≤100
	HDA-TR	10≤	15≤	10≤	15≤	20≤	30≤	15≤	20≤	25≤	35≤	-				
		<15	≤20	<15	<20	<30	≤50	<20	<25	<35	≤60	-				
$V_{Rd,seis}$	HDA-T	26	28	37,3	37,3	46,7	56	56	62	68	74,7	96	96	110	116,7	
		16,2	16,2	22,9	22,9	24,8	28,6	34,2	34,2	35,7	38,3	-				
	16		19,2			44,8				66,4						
	7,9		10,2			21,4				-						
$V_{Rd,seis}$	HDA-TR	16		19,2			44,8				66,4					
		7,9		10,2			21,4				-					
	16		19,2			44,8				66,4						
	7,9		10,2			21,4				-						
$V_{Rd,seis}$	HDA-P	16		19,2			44,8				66,4					
		7,9		10,2			21,4				-					
		16		19,2			44,8				66,4					
		7,9		10,2			21,4				-					
$V_{Rd,seis}$	HDA-PR	7,9		10,2			21,4				-					
		7,9		10,2			21,4				-					
		7,9		10,2			21,4				-					
		7,9		10,2			21,4				-					

Characteristic resistance in case of seismic performance category C1

Anchor size		M10		M12			M16				M20					
Tension $N_{Rk,seis}$	HDA-P, HDA-T	41,5		58			108,7				164					
	HDA-PR, HDA-TR	41,5		58			108,7				-					
Shear	for t_{fix}	HDA-T	10≤	15≤	10≤	15≤	20≤	15≤	20≤	25≤	30≤	35≤	20≤	25≤	40≤	55≤
			<15	≤20	<15	<20	≤50	<20	<25	<30	<35	≤60	<25	<40	<55	≤100
	HDA-TR	10≤	15≤	10≤	15≤	20≤	30≤	15≤	20≤	25≤	35≤	-				
		<15	≤20	<15	<20	<30	≤50	<20	<25	<35	≤60	-				
$V_{Rk,seis}$	HDA-T	65	70	80	80	100	140	140	155	170	190	205	205	235	250	
		HDA-TR	35,5	35,5	43,5	43,5	47	54,5	76	76	79	85	-			
		HDA-P	22		30			62				92				
		HDA-PR	11,5		17			31,5				-				

Design resistance in case of seismic performance category C1

Anchor size		M10		M12			M16				M20					
Tension $N_{Rd,seis}$	HDA-P, HDA-T	27,7		38,7			72,5				109,4					
	HDA-PR, HDA-TR	27,7		38,7			72,5				-					
Shear	for t_{fix}	HDA-T	10≤	15≤	10≤	15≤	20≤	15≤	20≤	25≤	30≤	35≤	20≤	25≤	40≤	55≤
			<15	≤20	<15	<20	≤50	<20	<25	<30	<35	≤60	<25	<40	<55	≤100
	HDA-TR	10≤	15≤	10≤	15≤	20≤	30≤	15≤	20≤	25≤	35≤	-				
		<15	≤20	<15	<20	<30	≤50	<20	<25	<35	≤60	-				
$V_{Rd,seis}$	HDA-T	43,3	46,7	53,3	53,3	66,7	93,3	93,3	103,3	113,3	126,7	136,7	136,7	156,7	166,7	
		HDA-TR	26,7	26,7	32,7	32,7	35,3	41	57,1	57,1	59,4	63,9	-			
		HDA-P	17,6		24			49,6				73,6				
		HDA-PR	8,6		12,8			23,7				-				

Static resistance

All data in this section applies to:

- Correct setting (See setting instruction)
- No edge distance and spacing influence
- *Steel* failure
- Minimum base material thickness
- Concrete C 20/25, $f_{ck,cube} = 25 \text{ N/mm}^2$

Effective anchorage depth for static

Anchor size	M10	M12	M16	M20
Eff. Anchorage depth h_{ef} [mm]	100	125	190	250

Characteristic resistance in case of static performance

Anchor size		M10	M12	M16	M20													
Non-cracked concrete																		
Tension N_{Rk}	HDA-P, HDA-T [kN]	46	67	126	192													
	HDA-PR, HDA-TR	46	67	126	-													
Cracked concrete																		
Tension N_{Rk}	HDA-P, HDA-T [kN]	25	35	75	95													
	HDA-PR, HDA-TR	25	35	75	-													
Non-cracked and cracked concrete																		
Shear	for t_{fix}	HDA-T [mm]	10≤	15≤	10≤	15≤	20≤	15≤	20≤	25≤	30≤	35≤	20≤	25≤	40≤	55≤		
			<15	≤20	<15	<20	≤50	<20	<25	<30	<35	≤60	<25	<40	<55	≤100		
	HDA-TR	10≤	15≤	10≤	15≤	20≤	30≤	15≤	20≤	25≤	35≤	-						
		<15	≤20	<15	<20	<30	≤50	<20	<25	<35	≤60	-						
	V_{Rk}	[kN]	HDA-T	65	70	80	80	100	140	140	155	170	190	205	205	235	250	
			HDA-TR	71	71	87	87	94	109	152	152	158	170	-				
			HDA-P	22		30			62			92						
			HDA-PR	23		34			63			-						

Design resistance in case of static performance

Anchor size		M10	M12	M16				M20									
Non-cracked concrete																	
Tension N_{Rd}	HDA-P, HDA-T [kN]	30,7	44,7	84				128									
	HDA-PR, HDA-TR	28,8	41,9	78,8				-									
Cracked concrete																	
Tension N_{Rd}	HDA-P, HDA-T [kN]	16,7	23,3	50				63,3									
	HDA-PR, HDA-TR	16,7	23,3	50				-									
Non-cracked and cracked concrete																	
Shear	for t_{fix}	HDA-T [mm]	10≤	15≤	10≤	15≤	20≤	15≤	20≤	25≤	30≤	35≤	20≤	25≤	40≤	55≤	
			<15	≤20	<15	<20	≤50	<20	<25	<30	<35	≤60	<25	<40	<55	≤100	
	HDA-TR	10≤	15≤	10≤	15≤	20≤	30≤	15≤	20≤	25≤	35≤	-					
		<15	≤20	<15	<20	<30	≤50	<20	<25	<35	≤60	-					
V_{Rd}	[kN]	HDA-T	43,3	46,7	53,3	53,3	66,7	93,3	93,3	103,3	113,3	126,7	136,7	136,7	156,7	166,7	
		HDA-TR	53,4	53,4	65,4	65,4	70,7	82,0	114,3	114,3	118,8	127,8	-				
		HDA-P	17,6	24				49,6				73,6					
		HDA-PR	17,3	25,6				47,4				-					

Materials

Mechanical properties of HDA

Anchor size	HDA-P, HDA-T				HDA-PR, HDA-TR		
	M10	M12	M16	M20 ^{a)}	M10	M12	M16
Anchor bolt							
Nominal tensile strength f_{uk} [N/mm ²]	800	800	800	800	800	800	800
Yield strength f_{yk}	640	640	640	640	600	600	600
Stressed cross-section A_s [mm ²]	58,0	84,3	157	245	58,0	84,3	157
Moment of resistance W_{el} [mm ³]	62,3	109,2	277,5	540,9	62,3	109,2	277,5
Characteristic bending resistance without sleeve $M_{Rk,s}^{0,b)}$ [Nm]	60	105	266	519	60	105	266
Anchor sleeve							
Nominal tensile strength f_{uk} [N/mm ²]	850	850	700	550	850	850	700
Yield strength f_{yk}	600	600	600	450	600	600	600

a) HDA M20: only a galvanized 5 μ m version is available

b) The recommended bending moment of the HDA anchor bolt may be calculated from $M_{rec} = M_{Rd,s} / \gamma_F = M_{Rk,s} / (\gamma_{MS} \cdot \gamma_F) = (1,2 \cdot W_{el} \cdot f_{uk}) / (\gamma_{MS} \cdot \gamma_F)$, where the partial safety factor for bolts of strength 8.8 is $\gamma_{MS} = 1,25$, for A4-80 equal to 1,33 and the partial safety factor for action may be taken as $\gamma_F = 1,4$. In case of HDA-T/TR/TF the bending capacity of the sleeve is neglected, only the capacity of the bolt is taken into account.

Material quality

Part	Material
HDA-P / HDA-T (Carbon steel version)	
Sleeve:	Machined steel with brazed tungsten carbide tips, galvanized to min. 5 µm
Bolt M10 - M16:	Cold formed steel, strength 8.8, galvanized to min. 5 µm
Bolt M20:	Cone machined, rod strength 8.8, galvanized to min. 5 µm
Washer M10-M16:	Spring washer, galvanized or coated
Washer M20:	Washer, galvanized
Centering washer	Machined steel
HDA-PR / HDA-TR (Stainless steel version)	
Sleeve:	Machined stainless steel with brazed tungsten carbide tips
Bolt M10 - M16:	Cone/rod: machined stainless steel
Washer	Spring washer stainless steel
Centering washer	Machined steel

Anchor dimensions

Anchor size			HDA-P / HDA-PR / HDA-T / HDA-TR						
			M10		M12		M16		M20
			x100/20	x125/30	x125/50	x190/40	x190/60	x250/50	x250/100
Length code letter			I	L	N	R	S	V	X
Total length of bolt	l_B	[mm]	150	190	210	275	295	360	410
Diameter of bolt	d_B	[mm]	10	12		16		20	
Total length of sleeve									
HDA-P	l_s	[mm]	100	125	125	190	190	250	250
HDA-T	l_s	[mm]	120	155	175	230	250	300	350
Max. diameter of sleeve	d_s	[mm]	19	21		29		35	
Washer diameter	d_w	[mm]	27,5	33,5		45,5		50	
Width across flats	S_w	[mm]	17	19		24		30	

HDA-P / HDA-PR

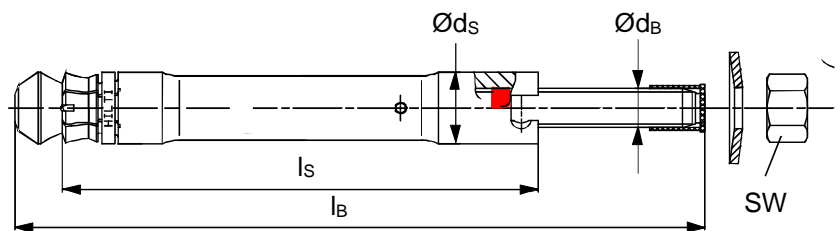

HDA-T / HDA-TR

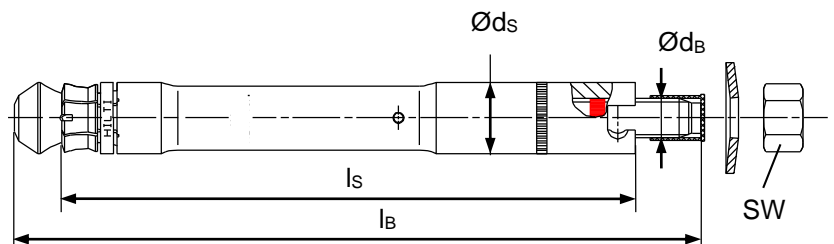

Settings

Setting details

Anchor size		HDA-P / HDA-PR / HDA-T / HDA-TR							
		M10		M12		M16		M20	
		x100/20	x125/30	x125/50	x190/40	x190/60	x250/50	x250/100	
Length code letter		I	L	N	R	S	V	X	
Nominal drill bit diameter	d_0 [mm]	20	22		30		37		
Cutting diameter of drill bit	$d_{cut,min}$ [mm]	20,10	22,10		30,10		37,15		
	$d_{cut,max}$ [mm]	20,55	22,55		30,55		37,70		
Depth of drill hole ^{a)}	$h_1 \geq$ [mm]	107	133		203		266		
Anchorage depth	h_{ef} [mm]	100	125		190		250		
Sleeve recess	$h_{s,min}$ [mm]	2	2		2		2		
	$h_{s,max}$ [mm]	6	7		8		8		
Torque moment	T_{inst} [Nm]	50	80		120		300		
For HDA-P/-PR									
Clearance hole	d_f [mm]	12	14		18		22		
Minimum base material thickness	h_{min} [mm]	180	200		270		350		
Fixture thickness	$t_{fix,min}$ [mm]	0	0		0		0		
	$t_{fix,max}$ [mm]	20	30	50	40	60	50	100	
For HDA-T/-TR									
Clearance hole	d_f [mm]	21	23		32		40		
Minimum base material thickness	h_{min} [mm]	200- t_{fix}	230- t_{fix}	250- t_{fix}	310- t_{fix}	330- t_{fix}	400- t_{fix}	450- t_{fix}	
Min. fixture thickness									
Tension load only!	$t_{fix,min}$ [mm]	10	10		15		20	50	
Shear load without use of centering washer	$t_{fix,min}$ [mm]	15	15		20		25	50	
Shear load - with use of centering washer	$t_{fix,min}^b$ [mm]	10	10		15		20	-	
Max. fixture thickness	$t_{fix,max}$ [mm]	20	30	50	40	60	50	100	

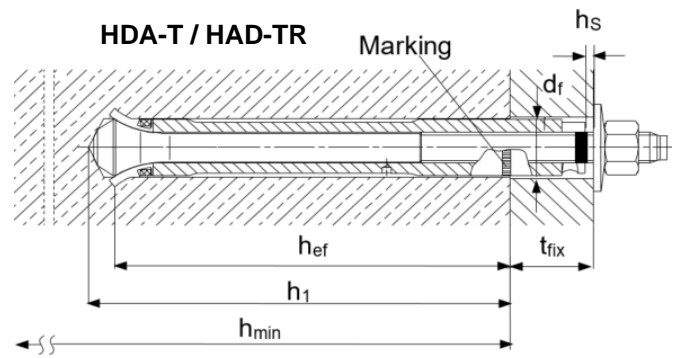
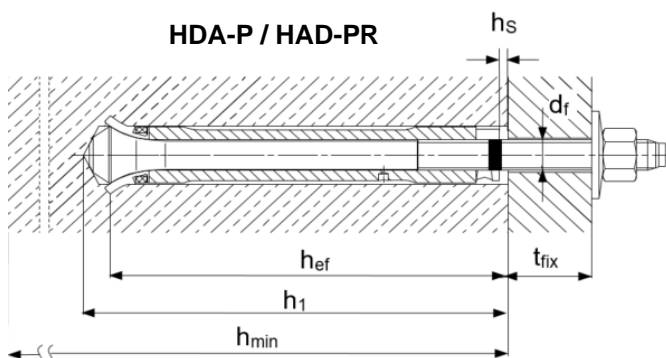

Anchor parameters

Anchor size			HDA-P / HDA-PR / HDA-T / HDA-TR					
			M10	M12		M16		M20
			x100/20	x125/30	x125/50	x190/40	x190/60	x250/50
Minimum spacing	S_{min}	[mm]	100	125		190		250
Minimum edge distance	C_{min}	[mm]	80	100		150		200
Critical spacing for splitting failure	$S_{cr,sp}$	[mm]	300	375		570		750
Critical edge distance for splitting failure	$C_{cr,sp}$	[mm]	150	190		285		375
Critical spacing for concrete cone failure	$S_{cr,N}$	[mm]	300	375		570		750
Critical edge distance for concrete cone failure	$C_{cr,N}$	[mm]	150	190		285		375

For spacing (edge distance) smaller than critical spacing (critical edge distance) the design loads have to be reduced.

Critical spacing and critical edge distance for splitting failure apply only for non-cracked concrete. For cracked concrete only the critical spacing and critical edge distance for concrete cone failure are decisive.

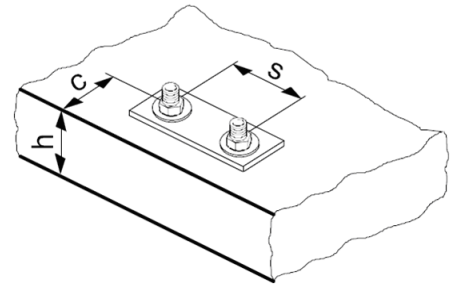

Stop drill bit HDA

The stop drill is required for drilling in order to achieve the correct hole depth.

The setting system (tool and setting tool) is required for transferring the specific energy for the undercutting process.

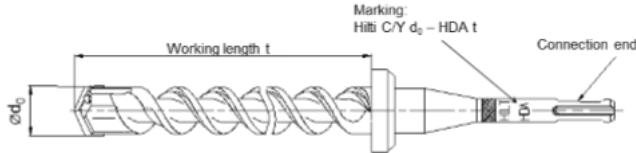

Required stop drill bits for HDA and HDA-R

Anchor	Stop drill bit with TE-C (SDS plus) connection end	Stop drill bit with TE-Y (SDS max) connection end	Nominal working length t [mm]	Drill bit diameter d ₀ [mm]
HDA-P/ PF/ PR M10x100/20	TE-C-HDA-B 20x100	TE-Y-HDA-B 20x100	107	20
HDA-T/ TF/ TR M10x100/20	TE-C-HDA-B 20x120	TE-Y-HDA-B 20x120	127	20
HDA-P/ PF/ PR M12x125/30 HDA-P/ PF/ PR M12x125/50	TE-C HDA-B 22x125	TE-Y HDA-B 22x125	133	22
HDA-T/ TF/ TR M12x125/30	TE-C HDA-B 22x155	TE-Y HDA-B 22x155	163	22
HDA-T/ TF/ TR M12x125/50	TE-C HDA-B 22x175	TE-Y HDA-B 22x175	183	22
HDA-P/ PF/ PR M16 x190/40 HDA-P/ PF/ PR M16 x190/60		TE-Y HDA-B 30x190	203	30
HDA-T/ TF/ TR M16x190/40		TE-Y HDA-B 30x230	243	30
HDA-T/ TF/ TR M16x190/60		TE-Y HDA-B 30x250	263	30
HDA-P M20 x250/50 HDA-P M20 x250/100		TE-Y HDA-B 37x250	266	37
HDA-T M20x250/50		TE-Y HDA-B 37x300	316	37
HDA-T M20x250/100		TE-Y HDA-B 37x350	366	37

Anchor	TE 24 a)	TE 30-A36	TE 35	TE 40	TE 40 AVR	TE 56	TE 56-ATC	TE 60	TE 60-ATC	TE 70	TE 70-ATC	TE 75	TE 76	TE 76-ATC	TE 80-ATC	TE 80-ATC AVR	Setting tool
HDA-P/T M10x100/20	■	■		■				■									TE-C-HDA-ST 20
																	TE-Y-HDA-ST 20
HDA-P/T M12x125/30	■	■		■													TE-C-HDA-ST 22
HDA-P/T M12x125/50								■	■								TE-Y-HDA-ST 22
HDA-P/T M16x190/40 HDA-P/T M16x190/60										■	■	■	■	■	■	■	TE-Y-HDA-ST 30 M16
HDA-P/T M20x250/50 HDA-P/T M20x250/100										■			■		■	■	TE-Y-HDA-ST 37 M20

a) 1st gear

Anchor											Setting tool
	TE 24 a) TE 25 a)	TE 30-A36	TE 35	TE 40 TE 40 AVR	TE 56 TE 56-ATC	TE 60 TE 60-ATC	TE 70 TE 70-ATC	TE 75	TE 76 TE 76-ATC	TE 80-ATC TE 80-ATC AVR	
HDA-PR/TR M10x100/20	■	■	■	■							TE-C-HDA-ST 20
					■	■					TE-Y-HDA-ST 20
HDA-PR/TR M12x125/30 HDA-PR/TR M12x125/50	■	■	■	■							TE-C-HDA-ST 22
					■	■					TE-Y-HDA-ST 22 M12
HDA-PR/TR M16x190/40 HDA-PR/TR M16x190/60							■	■	■	■	TE-Y-HDA-ST 30 M16

a) 1st gear

Anchor											Setting tool
	TE 24 a) TE 25 a)	TE 30-A36	TE 35	TE 40 TE 40 AVR	TE 56 TE 56-ATC	TE 60 TE 60-ATC	TE 70 TE 70-ATC	TE 75	TE 76 TE 76-ATC	TE 80-ATC TE 80-ATC AVR	
HDA-PF/TF M10x100/20		■	■	■		■					TE-C-HDA-ST 20 M10
HDA-PF/TF M12x125/30 HDA-PF/TF M12x125/50		■	■	■		■					TE-C-HDA-ST 22 M12
HDA-PF/TF M16x190/40 HDA-PF/TF M16x190/60							■	■	■	■	TE-Y-HDA-ST 30 M16

a) 1st gear

Setting instructions

*For detailed information on installation see instruction for use given with the package of the product.

HDA-P / HDA-PR (prepositioning)	
1. Drilling 	2. Cleaning
3. Inserting the anchor by hand 	4. Applying hammerdrill
5. Applying hammerdrill 	6. Checking
7. Attaching the fixture 	8. Attaching the belonging washer

HDA-T / HDA-TR (post-positioning)

1. Drilling

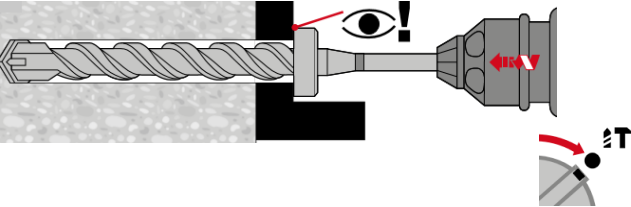

2. Cleaning

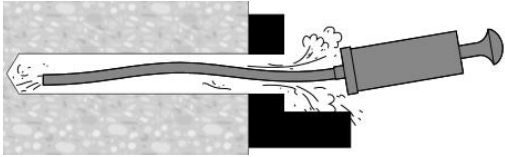

3. Inserting the anchor by hand

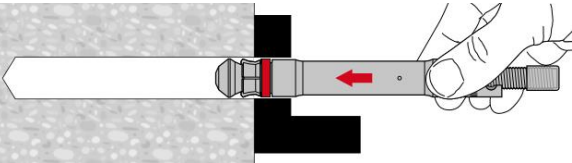

4. Applying hammerdrill

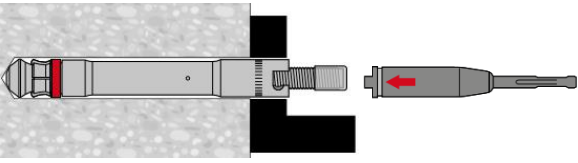

5. Checking

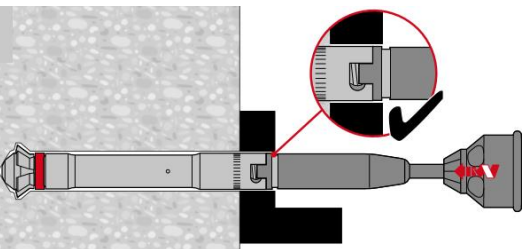

6. Checking

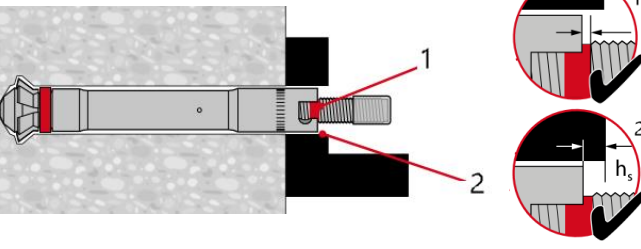



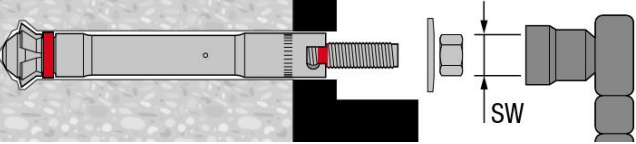

7. Attaching the belonging washer

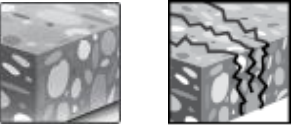

HMU-PF Undercut anchor

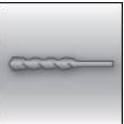
Anchor version	Benefits
 <p>HMU-PF M12x80 HMU-PF M16x100 HMU-PF M16x125</p>	<ul style="list-style-type: none"> - reliable mechanical interlock due to consistent high quality self-undercut - ETA approval for cracked and non-cracked concrete - Seismic approval ETA C1 - comes standard with a hot-dip galvanized protective coating against corrosion - cost efficient heavy duty anchoring solution for high volume fastenings - easy verification of correct setting due to red setting mark - optimized and matching system components enable efficient and reliable installation

<p>Base material</p>  <p>Concrete (non-cracked) Concrete (cracked)</p>	<p>Load conditions</p>  <p>Static/quasi-static Seismic ETA-C1 Fire resistance</p>
<p>Installation conditions</p>  <p>Hammer drilled holes</p>	<p>Other information</p>  <p>European Technical Assessment CE conformity PROFIS Anchor design Software</p>

Approvals / certificates

Description	Authority / Laboratory	No. / date of issue
European Technical Assessment ^{a)}	CSTB, Marne-la-Vallée	ETA-14/0069 / 2015-12-24

a) All data given in this section according to ETA-14/0069, issue 2015-12-24.

Seismic resistance (for a single anchor)

All data in this section applies to:

- Correct setting (See setting instruction)
- No edge distance and spacing influence
- *Steel* failure
- Minimum base material thickness
- Concrete C 20/25, $f_{ck,cube} = 25 \text{ N/mm}^2$
- $\alpha_{gap} = 1,0$ (using Hilti seismic filling set)

Effective anchorage depth for seismic C1

Anchor size		HMU-PF M12x80	HMU-PF M16x100	HMU-PF M16x125
Effective anchorage depth range	h_{ef} [mm]	80	100	125

Characteristic resistance in case of seismic performance category C1

Anchor size		HMU-PF M12x80	HMU-PF M16x100	HMU-PF M16x125
Tension $N_{Rk,seis}$	HMU-PF [kN]	17,3	30,6	42,8
Shear $V_{Rk,seis}$	HMU-PF	33,7	61,2	62,8

Design resistance in case of seismic category C1

Anchor size		HMU-PF M12x80	HMU-PF M16x100	HMU-PF M16x125
Tension $N_{Rd,seis}$	HMU-PF [kN]	11,5	20,4	28,5
Shear $V_{Rd,seis}$	HMU-PF	27,0	40,8	50,2

Static resistance

All data in this section applies to:

- Correct setting (See setting instruction)
- No edge distance and spacing influence
- *Steel* failure
- Minimum base material thickness
- Concrete C 20/25, $f_{ck,cube} = 25 \text{ N/mm}^2$

Effective anchorage depth for static

Anchor size		HMU-PF M12x80	HMU-PF M16x100	HMU-PF M16x125
Effective anchorage depth range	h_{ef} [mm]	80	100	125

Characteristic resistance in case of static performance

Anchor size		HMU-PF M12x80	HMU-PF M16x100	HMU-PF M16x125
Non cracked concrete				
Tension N_{Rk}	HMU-PF [kN]	36,1	50,5	70,6
Shear V_{Rk}	HMU-PF	33,7	62,8	62,8
Cracked concrete				
Tension N_{Rk}	HMU-PF [kN]	20	36	50,3
Shear V_{Rk}	HMU-PF	33,7	62,8	62,8



Design resistance in case of static performance

Anchor size			HMU-PF M12x80	HMU-PF M16x100	HMU-PF M16x125
Non-cracked concrete					
Tension N_{Rd}	HMU-PF	[kN]	24,1	33,7	47,1
Shear V_{Rd}	HMU-PF		27,0	50,2	50,2
Cracked concrete					
Tension N_{Rd}	HMU-PF	[kN]	13,3	24,0	33,5
Shear V_{Rd}	HMU-PF		27,0	48,0	50,2

Materials

Mechanical properties

Anchor size			HMU-PF M12x80	HMU-PF M16x100	HMU-PF M16x125
Nominal tensile strength	f_{uk}	[N/mm ²]	800		
Yield strength	f_{yk}	[N/mm ²]	640		
Stressed cross-section, thread	A_s	[mm ²]	84,3	157	
Moment of resistance	W	[mm ³]	109	278	
Char. bending resistance	$M^0_{Rk,s}$	[Nm]	105	266	

Material quality

Part	Material
Threaded bolt with cone	Carbon steel strength 8.8, hot dip galvanized to min. 50 µm
Sleeve	Carbon steel, hot dip galvanized min. 50µm
Hexagon nut	Steel grade 8, hot dip galvanized min. 50µm
Washer	According to DIN 125-1, 140 HV, hot dip galvanized min. 50µm

Letter code for anchor length

Anchor size	HMU-PF M12	M12x80/20	M12x80/35	M12x80/65
Letter code		H	I	K
Anchor size	HMU-PF M16	M16x100/30	M16x100/60	M16x125/60
Letter code		K	M	O

Anchor dimension

Anchor size			HMU-PF	HMU-PF M12x80	HMU-PF M16x100
Total length of bolt L_B	min	[mm]	133	167	222
	max		176	197	239
Diameter of sleeve	d_s	[mm]	17,5	21,6	
Length of sleeve	l_s	[mm]	80,6	100	125

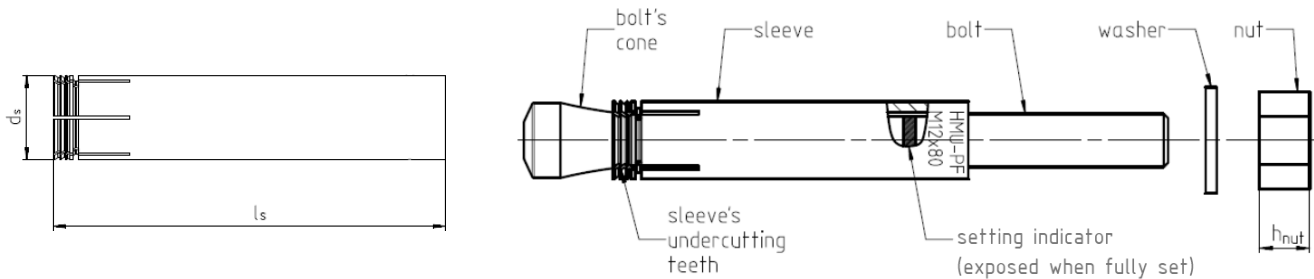
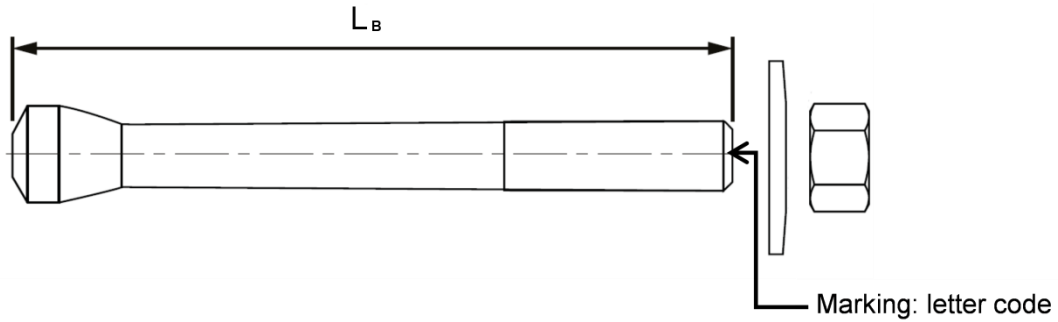

Setting

Setting details of HMU-PF





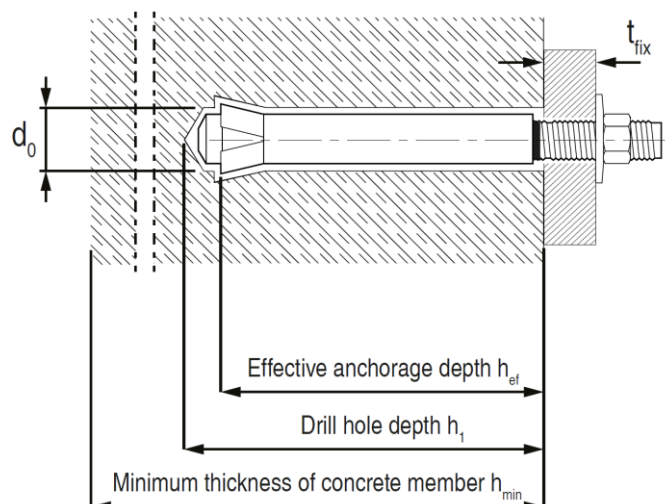

Anchor size			HMU-PF M12x80	HMU-PF M16x100	HMU-PF M16x125
Effective anchorage depth	h_{ef}	[mm]	80	100	125
Nominal Diameter of drill bit	d_0	[mm]	18	23	
Cutting diameter of drill bit ¹⁾	$d_{cut} \leq$	[mm]	18,5	23,0	
Depth of drill hole	$h_1 =$	[mm]	92	115	140
Diameter of clearance hole in the fixture	$d_f \leq$	[mm]	14	18	
Thickness of fixture	t_{fix}	Min.	2	0 ²⁾	0 ²⁾
		Max	65	60	75
Torque moment	T_{inst}	[Nm]	45	120	
Width across nut flats	SW	[mm]	19	24	

1) Use special stop drill bit TE-C-HMU-B only.

2) When thickness of attachment is less than 3mm, big washer acc. to DIN1052 standard needs to be used.



Installation equipment

Anchor size		HMU-PF M12x80 self-undercut	HMU-PF M16x100 self-undercut	HMU-PF M16x125 self-undercut
Rotary hammer For undercutting		TE 40 TE 30-A36	TE 40 TE 50	
Stop drill bit		TE-C-HMU-B M12x80	TE-C-HMU-B M16x100 TE-Y-HMU-B M16x100	TE-C-HMU-B M16x125 TE-Y-HMU-B M16x125
Setting tool		TE-C-HMU-ST-M12	TE-C-HMU-ST-M16 TE-Y-HMU-ST-M16	
Insert connections		 TE-C (SDS Plus)	 TE-C (SDS Plus)  TE-Y (SDS Max)	
Other tools		Blow-out bulb		

Setting parameters

Anchor size		HMU-PF M12x80	HMU-PF M16x100	HMU-PF M16x125
Effective anchorage depth	h_{ef} [mm]	80	100	125
Minimum base material thickness	$h_{min} \geq$ [mm]	160	200	250
Minimum spacing	$s_{min} \geq$ [mm]	90	100	100
Minimum edge distance	$c_{min} \geq$ [mm]	90	100	100
Critical spacing for splitting failure	$s_{cr,sp}$ [mm]	300	300	375
Critical edge distance for splitting failure	$c_{cr,sp}$ [mm]	150	160	200
Critical spacing for concrete cone failure	$s_{cr,N}$ [mm]	240	300	375
Critical edge distance for concrete cone failure	$c_{cr,N}$ [mm]	120	150	188

In case of smaller edge distance and spacing than $c_{cr,sp}$, $s_{cr,sp}$, $c_{cr,N}$ and $s_{cr,N}$ the load values shall be reduced according ETAG 001, Annex C

Critical spacing and critical edge distance for splitting failure apply only for non-cracked concrete.

For cracked concrete only the critical spacing and critical edge distance for concrete cone failure are decisive.

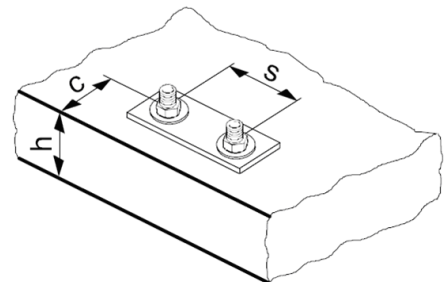













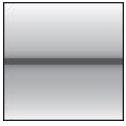

Setting instruction

*For detailed information on installation see instruction for use given with the package of the product.

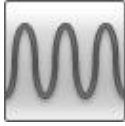
Setting instruction for HMU-PF	
1. Drilling 	2. Cleaning
3. Inserting the anchor by hand 	4. Applying hammer drill
5. Applying hammer drill 	6. Checking
7. Attaching the fixture 	8. Attaching the belonging washer

HSL-3 Expansion anchor

Anchor version		Benefits
	HSL-3 Bolt version	<ul style="list-style-type: none"> - size range from M8 to M24 - suitable for non-cracked and cracked concrete C 20/25 to C 50/60 - Seismic approval ETA C1, C2 - high loading capacity, especially in shear due to high strength sleeve - force-controlled expansion - reliable pull-down of the part fastened - no rotation in hole when tightening bolt - can be customized to a specific project need - easily removable for temporary fastening or retrofit
	HSL-3-G Threaded rod version	
	HSL-3-B Safety cap version	
	HSL-3-SH Hexagonal socketed head screws	
	HSL-3-SK Countersunk version	

Base material  Concrete (non-cracked)  Concrete (cracked)	Load conditions  Static/quasi-static  Seismic ETA-C1, C2  Fire resistance  Fatigue  Shock
Installation conditions  Hammer drilled holes  Diamond drilled holes	Other information  European Technical Assessment  CE conformity  HILTI PROFIS Anchor design Software

Approvals / certificates

Description	Authority / Laboratory	No. / date of issue
European technical Assessment ^{a)}	CSTB, Marne-la-Vallée	ETA-02/0042 / 2017-01-23
ICC-ES report incl. seismic	ICC evaluation service	ESR 1545 / 2017-01
Shock approval	Civil Protection of Switzerland	BZS D 08-601
Fire performance	Exova Warringtonfire	WF 327804/A / 2013-07-10
ACI 349-01 nuclear suitability	Wollmershauser consulting	WC 11-02 / 2011-09

a) All data given in this section according to ETA-02/0042, issue 2017-01-23.

Seismic resistance (for a single anchor)

All data in this section applies to:

- Correct setting (See setting instruction)
- No edge distance and spacing influence
- *Steel* failure
- Minimum base material thickness
- Concrete C 20/25, $f_{ck,cube} = 25 \text{ N/mm}^2$
- $\alpha_{gap} = 0,5$

Effective anchorage depth for seismic C2

Anchor size	M8	M10	M12	M16	M20	M24
Eff. Anchorage depth h_{ef} [mm]	-	70	80	100	125	-

Characteristic resistance in case of seismic category C2

Anchor size		M8	M10	M12	M16	M20	M24
Tension $N_{Rk,seis}$	HSL-3 / HSL-3-B [kN]	-	12,2	21,9	30,6	40,1	-
	HSL-3-SH / HSL-3-SK	-	12,2	21,9	-	-	-
	HSL-3-G	-	12,2	21,9	30,6	40,1	-
Shear $V_{Rk,seis}$	HSL-3 / HSL-3-B [kN]	-	9,4	13,2	25,4	39,1	-
	HSL-3-SH / HSL-3-SK	-	9,4	13,2	-	-	-
	HSL-3-G	-	9,0	11,3	22,3	25,1	-

Design resistance in case of seismic category C2

Anchor size		M8	M10	M12	M16	M20	M24
Tension $N_{Rd,seis}$	HSL-3 / HSL-3-B [kN]	-	8,1	14,6	20,4	26,7	-
	HSL-3-SH / HSL-3-SK	-	8,1	14,6	-	-	-
	HSL-3-G	-	8,1	14,6	20,4	26,7	-
Shear $V_{Rd,seis}$	HSL-3 / HSL-3-B [kN]	-	7,5	10,5	20,3	31,2	-
	HSL-3-SH / HSL-3-SK	-	7,5	10,5	-	-	-
	HSL-3-G	-	7,2	9,0	17,8	20,1	-

Effective anchorage depth for seismic C1

Anchor size	M8	M10	M12	M16	M20	M24
Eff. Anchorage depth h_{ef} [mm]	60	70	80	100	125	150

Characteristic resistance in case of seismic performance category C1

Anchor size		M8	M10	M12	M16	M20	M24
Tension $N_{Rk,seis}$	HSL-3 / HSL-3-B [kN]	12,0	16,0	21,9	30,6	42,8	56,2
	HSL-3-SH / HSL-3-SK	12,0	16,0	21,9	-	-	-
	HSL-3-G	12,0	16,0	21,9	30,6	42,8	-
Shear $V_{Rk,seis}$	HSL-3 / HSL-3-B [kN]	8,9	22,1	29,1	57,1	54,9	81,8
	HSL-3-SH / HSL-3-SK	8,9	22,1	29,1	-	-	-
	HSL-3-G	7,5	15,3	19,3	43,4	45,8	-

Design resistance in case of seismic performance category C1

Anchor size		M8	M10	M12	M16	M20	M24
Tension $N_{Rd,seis}$	HSL-3 / HSL-3-B	6,7	10,7	14,6	20,4	28,5	37,5
	HSL-3-SH / HSL-3-SK [kN]	6,7	10,7	14,6	-	-	-
	HSL-3-G	6,7	10,7	14,6	20,4	28,5	-
Shear $V_{Rd,seis}$	HSL-3 / HSL-3-B	7,1	17,7	23,3	40,8	43,9	65,4
	HSL-3-SH / HSL-3-SK [kN]	7,1	17,7	23,3	-	-	-
	HSL-3-G	6,0	12,2	15,4	34,7	36,6	-

Static resistance (for a single anchor)

All data in this section applies to:

- Correct setting (See setting instruction)
- No edge distance and spacing influence
- Steel failure
- Minimum base material thickness
- Concrete C 20/25, $f_{ck,cube} = 25 \text{ N/mm}^2$

Effective anchorage depth for static performance

Anchor size	M8	M10	M12	M16	M20	M24
Eff. Anchorage depth h_{ef} [mm]	60	70	80	100	125	150

Characteristic resistance in case of static performance

Anchor size		M8	M10	M12	M16	M20	M24
Non-cracked concrete							
Tension N_{Rk}	HSL-3 / HSL-3-B	[kN]	23,5	29,6	36,1	50,5	70,6
	HSL-3-SH / HSL-3-SK						
	HSL-3-SH						
Shear V_{Rk}	HSL-3 / HSL-3-B	[kN]	31,1	59,2	72,3	101,0	141,2
	HSL-3-SH / HSL-3-SK						
	HSL-3-G						
Cracked concrete							
Tension N_{Rk}	HSL-3 / HSL-3-B	[kN]	12,0	16,0	25,8	36,0	50,3
	HSL-3-SH / HSL-3-SK						
	HSL-3-SH						
Shear V_{Rk}	HSL-3 / HSL-3-B	[kN]	30,1	42,2	51,5	72,0	100,6
	HSL-3-SH / HSL-3-SK						
	HSL-3-G						

Design resistance in case of static performance

Non-cracked concrete							
Tension N_{Rd}	HSL-3 / HSL-3-B	[kN]	13,0	19,7	24,1	33,7	47,1
	HSL-3-SH / HSL-3-SK						
	HSL-3-SH						
Shear V_{Rd}	HSL-3-G	[kN]	24,9	39,4	48,2	67,3	94,1
	HSL-3 / HSL-3-B						
	HSL-3 / HSL-3-B						
Cracked concrete							
Tension N_{Rd}	HSL-3 / HSL-3-B	[kN]	6,7	10,7	17,2	24,0	33,5
	HSL-3-SH / HSL-3-SK						
	HSL-3-SH						
Shear V_{Rd}	HSL-3-G	[kN]	20,1	28,1	34,3	48,0	67,1
	HSL-3 / HSL-3-B						
	HSL-3 / HSL-3-B						

Materials

Mechanical properties of HSL-3, HSL-3-G, HSL-3-B, HSL-3-SH, HSL-3-SK

Anchor size	M8	M10	M12	M16	M20	M24
Nominal tensile strength f_{uk} [N/mm ²]	800	800	800	800	830	830
Yield strength f_{yk} [N/mm ²]	640	640	640	640	640	640
Stressed cross-section A_s [mm ²]	36,6	58,0	84,3	157	245	353
Moment of resistance W [mm ³]	31,3	62,5	109,4	277,1	540,6	935,4
Design bending resistance without sleeve $M_{Rd,s}$ [Nm]	24,0	48,0	84,0	212,8	415,2	718,4

Material quality

Part	Material
Bolt, threaded rod	steel strength 8.8, galvanised to min. 5 μ m

Anchor dimensions of HSL-3, HSL-3-G, HSL-3-B, HSL-3-B, HSL-3-SH, HSL-3-SK

Anchor version	Thread size	t_{fix} [mm]		d_s [mm]	l_1 [mm]	l_2 [mm]	l_3 [mm]	l_4 [mm]		p [mm]
		min	max					min	max	
HSL-3	M8	5	200	11,9	12	32	15,2	19	214	2
HSL-3-G	M10	5	200	14,8	14	36	17,2	23	218	3
HSL-3	M12	5	200	17,6	17	40	20	28	223	3
HSL-3-G	M16	10	200	23,6	20	54,4	24,4	34,5	224,5	4
HSL-3-B	M20	10	200	27,6	20	57	31,5	51	241	4
HSL-3	M24	10	200	31,6	22	65	39	57	247	4
HSL-3-SH	M8	5		11,9	12	32	15,2	19		2
	M10	20		14,8	14	36	17,2	38		3
	M12	25		17,6	17	40	20	48		3
HSL-3-SK	M8	10	20	11,9	12	32	15,2	18,2	28,2	2
	M10	20		14,8	14	36	17,2	32,2		3
	M12	25		17,6	17	40	20	40		3

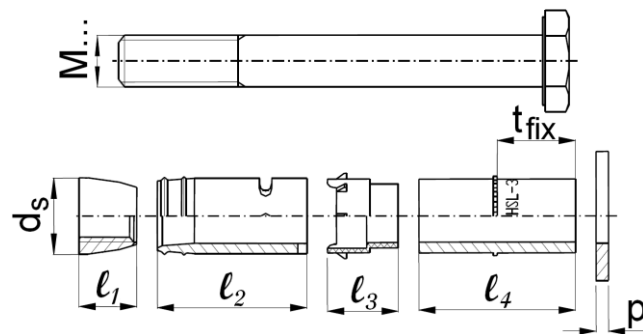

Setting

Setting details HSL-3

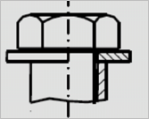
Anchor version HSL-3								
			M8	M10	M12	M16	M20	M24
Nominal diameter of drill bit	d_o	[mm]	12	15	18	24	28	32
Cutting diameter of drill bit	$d_{cut} \leq$	[mm]	12,5	15,5	18,5	24,55	28,55	32,7
Depth of drill hole	$h_1 \geq$	[mm]	80	90	105	125	155	180
Diameter of clearance hole in the fixture	$d_f \leq$	[mm]	14	17	20	26	31	35
Effective anchorage depth	h_{ef}	[mm]	60	70	80	100	125	150
Torque moment	T_{inst}	[Nm]	25	50	80	120	200	250
Width across	SW	[mm]	13	17	19	24	30	36

Setting details HSL-3-G

Anchor version HSL-3-G							
			M8	M10	M12	M16	M20
Nominal diameter of drill bit	d_o	[mm]	12	15	18	24	28
Cutting diameter of drill bit	$d_{cut} \leq$	[mm]	12,5	15,5	18,5	24,55	28,55
Depth of drill hole	$h_1 \geq$	[mm]	80	90	105	125	155
Diameter of clearance hole in the fixture	$d_f \leq$	[mm]	14	17	20	26	31
Effective anchorage depth	h_{ef}	[mm]	60	70	80	100	125
Torque moment	T_{inst}	[Nm]	20	35	60	80	160
Width across	SW	[mm]	13	17	19	24	30

Setting details HSL-3-B

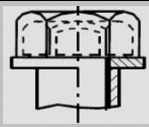
Anchor version HSL-3-B						
			M12	M16	M20	M24
Nominal diameter of drill bit	d_o	[mm]	18	24	28	32
Cutting diameter of drill bit	$d_{cut} \leq$	[mm]	18,5	24,55	28,55	32,7
Depth of drill hole	$h_1 \geq$	[mm]	105	125	155	180
Diameter of clearance hole in the fixture	$d_f \leq$	[mm]	20	26	31	35
Effective anchorage depth	h_{ef}	[mm]	80	100	125	150
Width across	SW	[mm]	24	30	36	41

Setting details HSL-3-SH

Anchor version HSL-3-SH			M8	M10	M12
Nominal diameter of drill bit	d_o	[mm]	12	15	18
Cutting diameter of drill bit	$d_{cut} \leq$	[mm]	12,5	15,5	18,5
Depth of drill hole	$h_1 \geq$	[mm]	85	95	110
Diameter of clearance hole in the fixture	$d_f \leq$	[mm]	14	17	20
Effective anchorage depth	h_{ef}	[mm]	60	70	80
Torque moment	T_{inst}	[Nm]	25	35	60
Width across	SW	[mm]	6	8	10

Setting details HSL-3-SK

Anchor version HSL-3-SK			M8	M10	M12
Nominal diameter of drill bit	d_o	[mm]	12	15	18
Cutting diameter of drill bit	$d_{cut} \leq$	[mm]	12,5	15,5	18,5
Depth of drill hole	$h_1 \geq$	[mm]	80	90	105
Diameter of clearance hole in the fixture	$d_f \leq$	[mm]	14	17	20
Diameter of countersunk hole in the fixture	$d_h =$	[mm]	22,5	25,5	32,9
Effective anchorage depth	h_{ef}	[mm]	60	70	80
Torque moment	T_{inst}	[Nm]	25	50	80
Width across	SW	[mm]	5	6	8

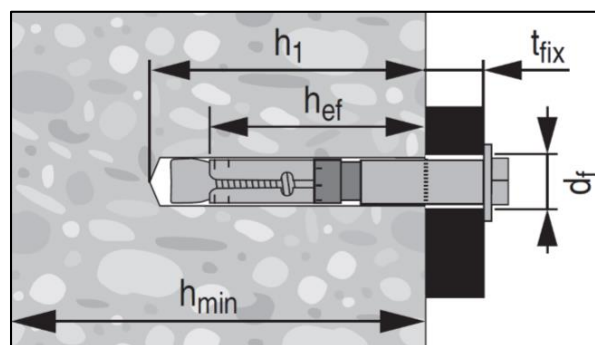

Installation equipment

Anchor size	M8	M10	M12	M16	M20	M24
Rotary hammer	TE2 – TE16			TE40 – TE80		
Diamond	DD EC-1 +DD-C T2 or DD120+DD-BI					
Other tools	hammer, torque wrench, blow out pump					

Setting parameters

Anchor size			M8	M10	M12	M16	M20	M24
Minimum base material thickness	h_{min}	[mm]	120	140	160	200	250	300
Minimum spacing	s_{min}	[mm]	60	70	80	100	125	150
	for $c \geq$	[mm]	100	100	160	240	300	300
Minimum edge distance	c_{min}	[mm]	60	70	80	100	150	150
	for $s \geq$	[mm]	100	160	240	240	300	300
Critical spacing for splitting failure	$s_{cr,sp}$	[mm]	230	270	300	380	480	570
Critical edge distance for splitting failure	$c_{cr,sp}$	[mm]	115	135	150	190	240	285
Critical spacing for concrete cone failure	$s_{cr,N}$	[mm]	180	210	240	300	375	450
Critical edge distance for concrete cone failure	$c_{cr,N}$	[mm]	90	105	120	150	187,5	225

For spacing (edge distance) smaller than critical spacing (critical edge distance) the design loads have to be reduced.

Critical spacing and critical edge distance for splitting failure apply only for non-cracked concrete. For cracked concrete only the critical spacing and critical edge distance for concrete cone failure are decisive.

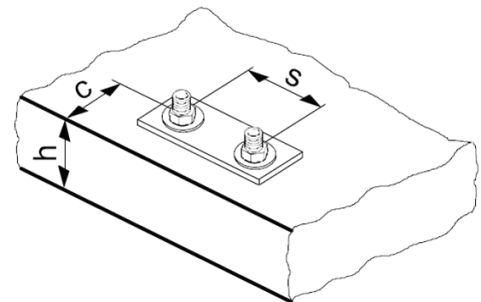











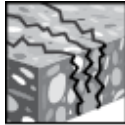
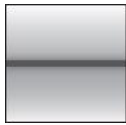

Setting instructions

*For detailed information on installation of each specific HSL versions see instruction for use given with the package of the product.

Setting instruction	
Hammer drilling	
1. Drilling 	2. Cleaning
3. Installation 	4. Applying tightening torque
Diamond drilling	
1. Drilling 	2. Cleaning
3. Installation 	4. Applying tightening torque

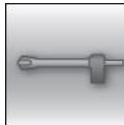
HST3 Expansion anchor

Anchor version	Benefits
 <p>HST3 Carbon steel</p>  <p>HST3-R Stainless steel</p>	<ul style="list-style-type: none"> - highest resistance for reduced member thickness, short spacing and edge distances - increased undercut percentage in combination with optimized coating - suitable for non-cracked and cracked concrete C 12/15 to C 80/95 - highly reliable and safe anchor for structural seismic design with ETA C1/C2 approval - flexibility with two embedment depths included in the ETA - minimum edge and spacing distances reduced by up to 25% compared to HST - design tension resistance increased by up to 66% compared to HST - product and length identification mark facilitates quality control and inspection
 <p>HST3-BW Carbon steel</p>  <p>HST3-R-BW Stainless steel</p>	

<p>Base material</p>  <p>Concrete (non-cracked)</p>  <p>Concrete (cracked)</p>	<p>Load conditions</p>  <p>Static/ quasi-static</p>  <p>Seismic ETA-C1/C2</p>  <p>Fire resistance</p>
<p>Installation conditions</p>  <p>Hammer drilled holes</p>  <p>Diamond drilled holes</p>  <p>Hollow drill-bit drilling</p>	<p>Other information</p>  <p>European Technical Assessment</p>  <p>CE conformity</p>  <p>PROFIS Anchor design Software</p>  <p>FM approved</p>

Approvals / certificates

Description	Authority / Laboratory	No. / date of issue
European technical assessment ^{a)}	DIBt, Berlin	ETA-98/0001 / 2016-28-07

a) All data given in this section according to ETA-98/0001, issue 2016-28-07.

Seismic resistance (for a single anchor)

All data in this section applies to:

- Correct setting (See setting instruction)
- No edge distance and spacing influence
- *Steel* failure
- Minimum base material thickness
- Concrete C 20/25, $f_{ck,cube} = 25 \text{ N/mm}^2$
- $\alpha_{gap} = 1,0$ (using Hilti seismic filling set)

Effective anchorage depth for seismic C2 and C1

Anchor size			M8	M10	M12	M16	M20
Eff. Anchorage depth	h_{ef}	[mm]	47	60	70	85	101

Characteristic resistance in case of seismic performance category C2

Anchor size			M8	M10	M12	M16	M20
Tension $N_{Rk,seis}$	HST3 / HST3-BW	[kN]	3,0	10,4	17,9	24,0	31,1
	HST3-R / HST3-R-BW		3,4	10,4	17,9	24,0	31,1
Shear $V_{Rk,seis}$	HST3 / HST3-BW	[kN]	9,9	19,0	28,6	48,5	84,3
	HST3-R / HST3-R-BW		9,9	17,2	27,6	42,5	67,4

Design resistance in case of seismic performance category C2

Anchor size			M8	M10	M12	M16	M20
Tension $N_{Rd,seis}$	HST3 / HST3-BW	[kN]	1,7	6,9	11,9	16,0	20,7
	HST3-R / HST3-R-BW		2,3	6,9	11,9	16,0	20,7
Shear $V_{Rd,seis}$	HST3 / HST3-BW	[kN]	7,9	15,2	22,9	38,8	66,3
	HST3-R / HST3-R-BW		7,9	13,8	22,1	34,0	53,9

Characteristic resistance in case of seismic performance category C1

Anchor size			M8	M10	M12	M16	M20
Tension $N_{Rk,seis}$	HST3 / HST3-BW	[kN]	7,5	12,0	17,9	24,0	31,1
	HST3-R / HST3-R-BW		7,5	12,0	17,9	24,0	31,1
Shear $V_{Rk,seis}$	HST3 / HST3-BW	[kN]	16,6	25,8	39,0	60,9	99,4
	HST3-R / HST3-R-BW		19,5	28,4	44,3	70,2	99,4

Design resistance in case of seismic performance category C1

Anchor size			M8	M10	M12	M16	M20
Tension $N_{Rd,seis}$	HST3 / HST3-BW	[kN]	4,2	8,0	11,9	16,0	20,7
	HST3-R / HST3-R-BW		4,5	8,0	11,9	16,0	20,7
Shear $V_{Rd,seis}$	HST3 / HST3-BW	[kN]	13,3	20,6	31,2	48,7	66,3
	HST3-R / HST3-R-BW		15,6	22,7	33,2	54,5	66,3

Static resistance (for a single anchor)

All data in this section applies to:

- Correct setting (See setting instruction)
- No edge distance and spacing influence
- Steel failure
- Minimum base material thickness
- Concrete C 20/25, $f_{ck,cube} = 25 \text{ N/mm}^2$

Effective anchorage depth for static

Anchor size		M8	M10		M12		M16		M20
Eff. Anchorage depth	h_{ef} [mm]	47	40	60	50	70	65	85	101

Characteristic resistance in case of static performance

Anchor size		M8	M10		M12		M16		M20	
Non-cracked concrete										
Tension N_{Rk}	HST3/HST3-BW	[kN]	12,0	12,8	20,0	17,9	25,0	26,5	39,6	51,3
	HST3-R/HST3-R-BW		12,0	12,8	20,0	17,9	25,0	26,5	39,6	51,3
Shear V_{Rk}	HST3/HST3-BW	[kN]	16,6	23,7	25,8	35,6	39,0	60,9	60,9	100,4
	HST3-R/HST3-R-BW		19,5	28,4	28,4	44,3	44,3	70,2	70,2	102,7
Cracked concrete										
Tension N_{Rk}	HST3/HST3-BW	[kN]	7,5	9,1	12,0	12,7	20,0	18,9	28,2	36,5
	HST3-R/HST3-R-BW		7,5	9,1	12,0	12,7	20,0	18,9	28,2	36,5
Shear V_{Rk}	HST3/HST3-BW	[kN]	16,6	23,7	25,8	35,6	39	60,9	60,9	100,4
	HST3-R/HST3-R-BW		19,5	23,7	28,4	35,6	44,3	64,1	70,2	102,7

Design resistance in case of static performance

Anchor size		M8	M10		M12		M16		M20	
Non-cracked concrete										
Tension N_{Rd}	HST3/HST3-BW	[kN]	8,0	8,5	13,3	11,9	16,7	17,6	26,4	34,2
	HST3-R/HST3-R-BW		8,0	8,5	13,3	11,9	16,7	17,6	26,4	34,2
Shear V_{Rd}	HST3/HST3-BW	[kN]	13,0	20,6	20,6	31,2	31,2	48,7	48,7	80,3
	HST3-R/HST3-R-BW		15,6	22,1	22,7	33,3	35,4	56,2	56,2	82,2
Cracked concrete										
Tension N_{Rd}	HST3/HST3-BW	[kN]	5,0	7,3	8,0	10,2	13,3	15,1	22,6	29,2
	HST3-R/HST3-R-BW		5,0	6,1	8,0	8,5	13,3	12,6	18,8	24,4
Shear V_{Rd}	HST3/HST3-BW	[kN]	13,3	15,8	20,6	23,8	31,2	42,8	48,7	80,3
	HST3-R/HST3-R-BW		15,6	15,8	22,7	23,8	35,4	42,8	56,2	82,2

Materials

Mechanical properties

Anchor size			M8	M10	M12	M16	M20
Nominal tensile strength $f_{uk,thread}$	HST3/HST3-BW	[N/mm ²]	800	800	800	720	700
	HST3-R/HST3-R-BW		720	710	710	650	650
Yield strength $f_{yk,thread}$	HST3/HST3-BW	[N/mm ²]	640	640	640	576	560
	HST3-R/HST3-R-BW		576	568	568	520	520
Stressed cross-section A_s			36,6	58,0	84,3	157	245
Moment of resistance W			31,2	62,3	109	277	541
Char. bending resistance $M_{Rk,s}^0$	HST3/HST3-BW	[Nm]	30	60	105	240	457
	HST3-R/HST3-R-BW		27	53	93	216	425

Material quality

Part	Material	
Bolt	HST3/HST3-BW	Carbon steel, galvanized to min. 5 μ m
	HST3-R/HST3-R-BW	Stainless steel

Anchor dimensions of HST3, HST3-BW, HST3-R, HST3-R-BW

Anchor size			M8	M10	M12	M16	M20
Minimum thickness of fixture	$t_{fix,min}$	[mm]	2	2	2	2	2
Maximum thickness of fixture	$t_{fix,max}$	[mm]	195	220	270	370	310
Shaft diameter at the cone	d_R	[mm]	5,60	6,94	8,22	11,00	14,62
Minimum length of the anchor	$l_{1,min}$	[mm]	75	90	115	140	170
Maximum length of the anchor	$l_{1,max}$	[mm]	260	280	350	475	450
Length of expansion sleeve	l_2	[mm]	13,6	16,0	20,0	25,0	28,3

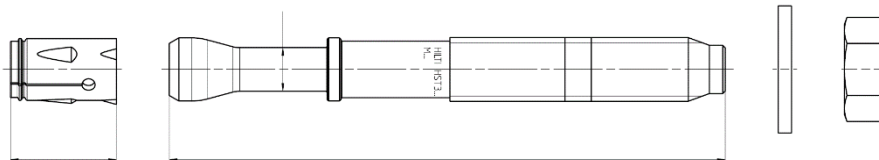

Setting

Setting details

Anchor size			M8	M10	M12	M16	M20
Nominal diameter of drill bit	d_o	[mm]	8	10	12	16	20
Cutting diameter of drill bit	$d_{cut} \leq$	[mm]	8,45	10,45	12,5	16,5	20,55
Nominal anchorage depth	$h_{nom,1}$	[mm]	-	48	60	78	-
	$h_{nom,2}$	[mm]	54	68	80	98	116
Effective anchorage depth	$h_{ef,1}^{a)}$	[mm]	-	40	50	65	-
	$h_{ef,2}^{b)}$	[mm]	47	60	70	85	101
Depth of drill hole (hammer drilled holes)	$h_{1,1h}$	[mm]	-	53	68	86	-
	$h_{1,2h}$	[mm]	59	73	88	106	124
Depth of drill hole (diamond drilled holes)	$h_{1,1d}$	[mm]	-	58	70	88	-
	$h_{1,2d}$	[mm]	64	78	90	108	-
Diameter of clearance hole in the fixture	$d_f \leq$	[mm]	9	12	14	18	22
Torque moment	T_{inst}	[Nm]	20	45	60	110	180
Width across	S_w	[mm]	13	17	19	24	30

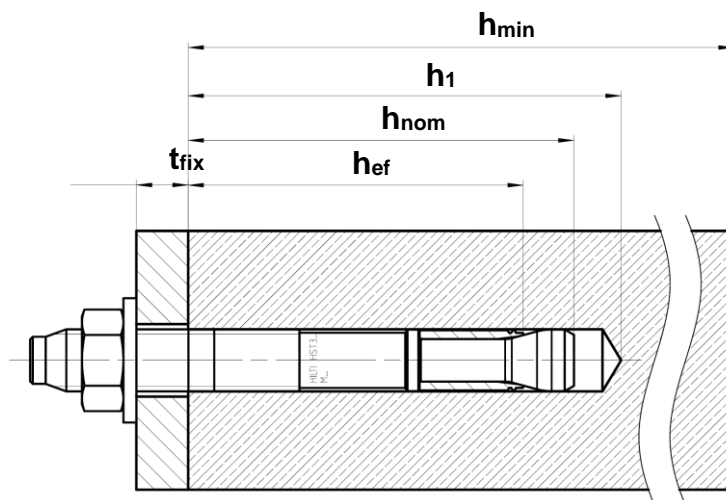

Setting parameters for M8, M10, M12, M16 and concrete class C20/25 to C50/60

Anchor Size		M8		M10		M12			M16				
Effective anchorage depth	h_{ef} [mm]	47		60		50	70	70	65	85		85	
Minimum base material thickness	h_{min} [mm]	80	100	100	120	100	120	140	140	120	140	160	160
Minimum spacing in <i>non-cracked</i> concrete	s_{min} [mm]	35	35	40	40	55	50	60	110	75	80	65	90
	for $c \geq$ [mm]	55	50	100	60	110	100	70	140	140	130	95	145
Minimum spacing in <i>cracked</i> concrete	s_{min} [mm]	35	35	40	40	50	50	50	80	65	80	65	70
	for $c \geq$ [mm]	50	50	100	55	105	90	70	120	130	130	95	125
Minimum edge distance in <i>non-cracked</i> concrete	c_{min} [mm]	40	40	60	50	60	60	55	90	65	65	65	110
	for $s \geq$ [mm]	60	50	90	90	210	120	110	190	240	180	150	170
Minimum edge distance in <i>cracked</i> concrete	c_{min} [mm]	40	40	60	45	55	60	55	80	65	65	65	90
	for $s \geq$ [mm]	50	50	90	80	210	120	110	170	240	180	150	165
Critical spacing for splitting failure and concrete cone failure	$s_{cr,sp}$ [mm]	141	141	180	180	100	210	280	208	255	340		
	$s_{cr,N}$ [mm]	141		180		150		210	195		255		
Critical edge distance for splitting failure and concrete cone failure	$c_{cr,sp}$ [mm]	71	71	90	90	90	105	140	104	128	170		
	$c_{cr,N}$ [mm]	71		90		75		105	98		128		

Installation equipment

Anchor size	M8	M10	M12	M16	M20
Rotary hammer	TE2(-A) – TE30(-A)				TE40 – TE80
Diamond coring tool	DD-30W, DD-EC1				
Setting tool	Setting tool HS-SC				-
Hollow drill bit	-	TE-CD, TE-YD			
Other tools	hammer, torque wrench, blow out pump				

Setting parameters for M20 and concrete class C20/25 to C50/60

Anchor size		M20				
Effective anchorage depth	h_{ef}	[mm]	101		101	
Minimum base material thickness	h_{min}	[mm]	160	200	200	
Minimum spacing in <i>non-cracked</i> concrete	HST3/HST3-BW	s_{min}	[mm]	120	90	90
		for $c \geq$	[mm]	180	130	165
	HST3-R/ HST3-R-BW	s_{min}	[mm]	120	90	90
		for $c \geq$	[mm]	180	130	165
Minimum spacing in <i>cracked</i> concrete	HST3/HST3-BW	s_{min}	[mm]	120	90	90
		for $c \geq$	[mm]	180	130	140
	HST3-R/ HST3-R-BW	s_{min}	[mm]	120	90	90
		for $c \geq$	[mm]	180	130	140
Minimum edge distance in <i>non-cracked</i> concrete	HST3/HST3-BW	c_{min}	[mm]	120	80	120
		for $s \geq$	[mm]	180	180	270
	HST3-R/ HST3-R-BW	c_{min}	[mm]	120	80	120
		for $s \geq$	[mm]	180	180	270
Minimum edge distance in <i>cracked</i> concrete	HST3/HST3-BW	c_{min}	[mm]	120	80	100
		for $s \geq$	[mm]	180	180	240
	HST3-R/ HST3-R-BW	c_{min}	[mm]	120	80	100
		for $s \geq$	[mm]	180	180	240
Critical spacing for splitting failure and concrete cone failure	$s_{cr,sp}$	[mm]	384		404	
	$s_{cr,N}$	[mm]	303		303	
Critical edge distance for splitting failure and concrete cone failure	$c_{cr,sp}$	[mm]	192		202	
	$c_{cr,N}$	[mm]	152		152	

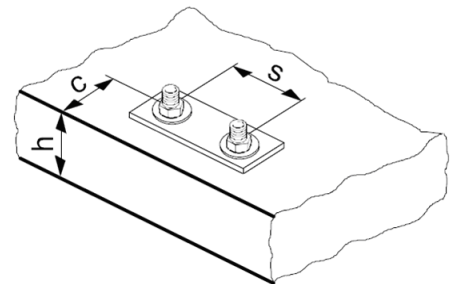

Setting instructions

*For detailed information on installation see instruction for use given with the package of the product

Setting instruction for HST3, HST3-BW, HST3-R, HST3-R-BW	
Hammer drilling (M8, M10, M12, M16, M20, M24)	
<p>1. Drilling</p> <p>$h_1 = h_{nom} + 5 \text{ mm}$ 90° $d_0 = \text{Ø } 8 \text{ mm}$</p>	<p>2. Cleaning</p>
<p>3. Inserting</p>	<p>4. Checking</p>
<p>5. Attaching washer</p> <p>$T_{inst} = 20 \text{ Nm}$ 13 mm</p>	
Hollow Drill Bit (M16, M20, M24)	
<p>1. Drilling</p>	<p>2. Inserting</p>
<p>3. Checking</p>	<p>4. Attaching washer</p> <p>$T_{inst} = 20 \text{ Nm}$ 13 mm</p>

Diamond coring (M8, M10, M12, M16, M20, M24)

1. Coring

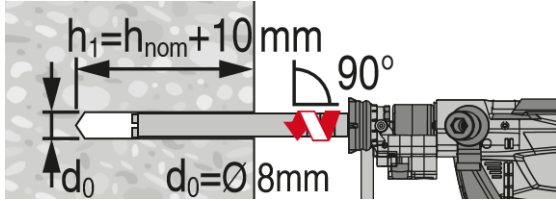

2. Flushing

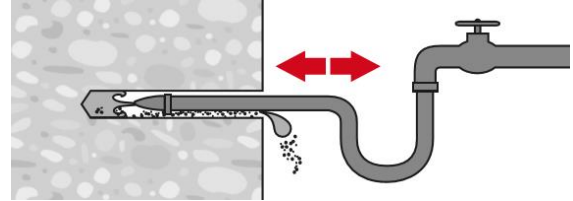

3. Cleaning

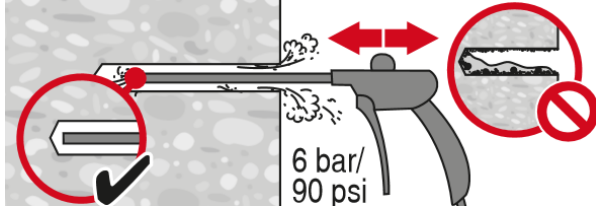

4. Inserting and Checking

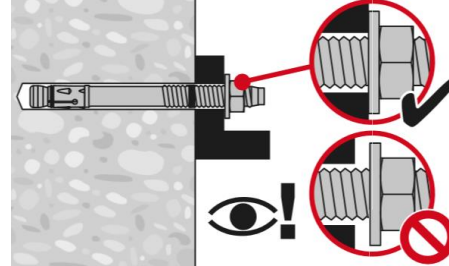

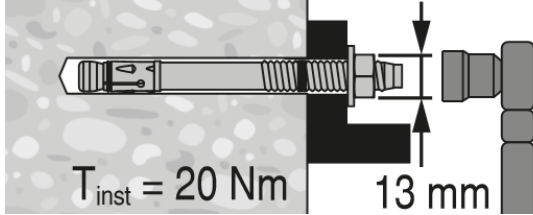

5. Attaching the belonging washer



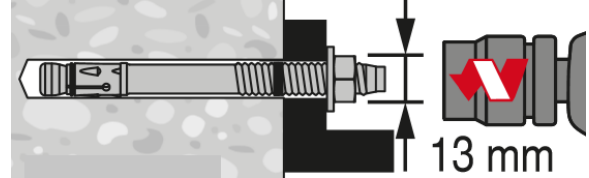





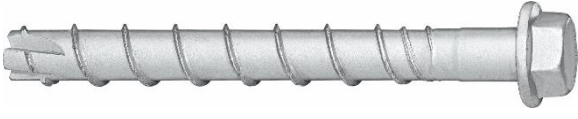

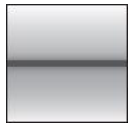

6. Attaching the belonging washer



HUS3 Screw anchor

Anchor version	Benefits
 <p>HUS3-H 8 / 10 / 14 Carbon steel concrete screw with hexagonal head</p>	<ul style="list-style-type: none"> - High productivity – less drilling and fewer operations than with conventional anchors - ETA approval for cracked and non-cracked concrete - ETA approval for adjustability (unscrew-rescrew) - Seismic approval ETA C1, C2 - High loads - Small edge and spacing distances - abZ (DIBt) approval for reusability in fresh concrete ($f_{ck,cube}=10/15/20$ Nmm²) for temporary applications - Three embedment depths for maximum design flexibility - Forged-on washer and hexagon head with no protruding thread - Through fastening
 <p>HUS3-C 8 / 10 Carbon steel concrete screw with countersunk head</p>	
 <p>HUS3-HF 8 / 10 / 14 Carbon steel concrete screw with multilayer coating and hexagonal head</p>	

<p>Base material</p> <div style="display: flex; justify-content: space-around;"> <div style="text-align: center;">  <p>Concrete (non- cracked)</p> </div> <div style="text-align: center;">  <p>Concrete (cracked)</p> </div> </div>	<p>Load conditions</p> <div style="display: flex; justify-content: space-around;"> <div style="text-align: center;">  <p>Static/ quasi-static</p> </div> <div style="text-align: center;">  <p>Seismic ETA-C1, C2</p> </div> <div style="text-align: center;">  <p>Fire resistance</p> </div> </div>
<p>Installation conditions</p> <div style="text-align: center;">  <p>Hammer drilled holes</p> </div>	<p>Other information</p> <div style="display: flex; justify-content: space-around;"> <div style="text-align: center;">  <p>European Technical Assessment</p> </div> <div style="text-align: center;">  <p>CE conformity</p> </div> <div style="text-align: center;">  <p>PROFIS Anchor design Software</p> </div> <div style="text-align: center;">  <p>DIBt Approval Reusability</p> </div> </div>

Approvals / certificates

Description	Authority / Laboratory	No. / date of issue
European technical assessment ^{a)}	DIBt, Berlin	ETA-13/1038 / 2016-12-08

a) All data given in this section according to ETA-13/1038, issue 2016-12-08.

Seismic loading data (for a single anchor)

All data in this section applies to:

- Correct setting (See setting instruction)
- No edge distance and spacing influence
- *Steel* failure
- Minimum base material thickness
- Concrete C 20/25, $f_{ck,cube} = 25 \text{ N/mm}^2$
- $\alpha_{gap} = 1,0$ (using Hilti seismic filling set)

Anchorage depth for seismic C2

Anchor size			10		10		14	
			h_{nom3}		h_{nom3}		h_{nom3}	
Nominal anchor. depth range	HUS3 -H	h_{nom} [mm]	-		85		115	
Effective anchorage depth	HUS3 -H	h_{ef} [mm]	-		67,1		91,8	

Characteristic resistance in case of seismic performance category C2

Anchor size			8	10	14
Tension $N_{Rk,seis}$	HUS3-H	[kN]	-	9,4	17,7
Shear $V_{Rk,seis}$	HUS3-H		-	25,6	46,6

Design resistance in case of seismic performance category C2

Anchor size			8	10	14
Tension $N_{Rd,seis}$	HUS3-H	[kN]	-	6,3	11,8
Shear $V_{Rd,seis}$	HUS3-H		-	17,1	31,1

Anchorage depth for seismic C1

Anchor size			8		10		14	
			h_{nom2}	h_{nom3}	h_{nom2}	h_{nom3}	h_{nom2}	h_{nom3}
Nominal anchorage depth range	HUS3-H	h_{nom} [mm]	60	70	75	85	85	115
Effective anchorage depth	HUS3-H	h_{ef} [mm]	46,4	54,9	58,6	67,1	66,3	91,8

Characteristic resistance in case of seismic performance category C1

Anchor size			8		10		14	
Tension $N_{Rk,seis}$	HUS3-H	[kN]	9,0	12,0	13,8	16,8	16,5	26,9
Shear $V_{Rk,seis}$	HUS3-H		11,9	11,9	16,8	17,7	22,5	34,5

Design resistance in case of seismic performance category C1

Anchor size			8		10		14	
Tension $N_{Rd,seis}$	HUS3-H	[kN]	6,0	8,0	9,2	11,2	11,0	17,9
Shear $V_{Rd,seis}$	HUS3-H		7,9	7,9	11,2	11,8	15,0	23,0

This technical data sheet does not include seismic technical data of HUS3-C and HUS3-HF. Please refer to ETA-13/1038 / 2016-12-08 or Hilti Profis anchor software for more details.

Static and quasi-static loading data (for single anchor)

All data in this section applies to:

- Correct setting (See setting instruction)
- No edge distance and spacing influence
- Steel failure
- Minimum base material thickness
- Concrete C 20/25, $f_{ck,cube} = 25 \text{ N/mm}^2$

Anchorage depth for static

Anchor size			8			10			14		
Type	HUS3 -		H, C, HF			H, C, HF			H, HF		H
Nominal anchorage depth range	h_{nom}	[mm]	h_{nom1}	h_{nom2}	h_{nom3}	h_{nom1}	h_{nom2}	h_{nom3}	h_{nom1}	h_{nom2}	h_{nom3}
			50	60	70	55	75	85	65	85	115
Effective anchorage depth	h_{ef}	[mm]	40	46,4	54,9	41,6	58,6	67,1	49,3	66,3	91,8

Characteristic resistance in case of static performance

Anchor size			8			10			14		
Type	HUS3 -		H, C, HF			H, C, HF			H, HF		H
Non cracked concrete											
Tension N_{Rk}	[kN]		9	12	16	12	20	27,8	17,5	27,3	44,4
Shear V_{Rk}	[kN]		12,8	19	22	13,5	30	34	35	54,5	62
Cracked concrete											
Tension N_{Rk}	[kN]		6	9	12	9,7	16,2	19,8	12,5	19,4	31,7
Shear V_{Rk}	[kN]		9,1	19	22	9,7	30	34	24,9	38,9	62

Design resistance in case of static performance

Anchor size			8			10			14		
Type	HUS3 -		H, C, HF			H, C, HF			H, HF		H
Non cracked concrete											
Tension N_{Rkd}	[kN]		6	8	10,7	8	13,3	18,5	11,7	18,2	29,6
Shear V_{Rd}	[kN]		8,5	12,7	14,7	9	20	22,7	23,3	36,3	41,3
Cracked concrete											
Tension N_{Rd}	[kN]		4	6	8	6,4	10,8	13,2	8,3	13	21,1
Shear V_{Rd}	[kN]		6,1	12,7	14,7	6,4	20	22,7	16,6	25,9	41,3

Materials

Mechanical properties

Anchor size		8			10			14		
Type	HUS3-	C, H, HF			C, H, HF			H, HF		
Nominal tensile strength f_{uk}	[N/mm ²]	810			805			730		
Yield strength f_{yk}	[N/mm ²]	695			690			630		
Stressed cross-section A_s	[mm ²]	48,4			77,0			131,7		
Moment of resistance W	[mm ³]	47			95			213		
Char, bending resistance $M_{Rk,s}^0$	[Nm]	46			92			187		

Material properties

Anchor type	Material
HUS3-C	Countersunk head configuration, galvanized
HUS3-H	Hexagonal head configuration, galvanized
HUS3-HF	Hexagonal head configuration, multilayer coating

Anchor dimension

Anchor size			8			10			14		
Type			C, H, HF			C, H, HF			H, HF		H
Nominal embedment depth	h_{nom}	[mm]	h_{nom1}	h_{nom2}	h_{nom3}	h_{nom1}	h_{nom2}	h_{nom3}	h_{nom1}	h_{nom2}	h_{nom3}
			50	60	70	55	75	85	65	85	115
Threaded outer diameter	d_t	[mm]	10,3			12,4			16,85		
Core diameter	d_k	[mm]	7,85			9,90			12,95		
Shaft diameter	d_s	[mm]	8,45			10,55			13,80		
Stressed section	A_s	[mm ²]	48,4			77,0			131,7		

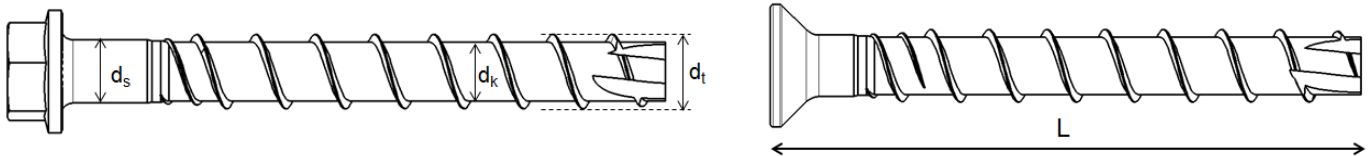

Screw length and maximum thickness of fixture for HUS3-C

Anchor size			8			10		
Type			C			C		
Nominal embedment depth	h_{nom}	[mm]	h_{nom1}	h_{nom2}	h_{nom3}	h_{nom1}	h_{nom2}	h_{nom3}
			50	60	70	55	75	85
Thickness of fixture [mm]	t_{fix}	[mm]	t_{fix1}	t_{fix2}	t_{fix3}	t_{fix1}	t_{fix2}	t_{fix3}
			15	5	-	-	-	-
Length of screw [mm]	65		-	-	-	15	-	-
	70		-	-	-	-	-	-
	75		25	15	-	-	-	-
	85		35	25	15	-	-	-
	90		-	-	-	35	15	-
	100		-	-	-	45	25	15

Screw length and maximum thickness of fixture for HUS3-H, HF

Anchor size			8			10			14		
Type			H, HF			H, HF			H, HF		H
Nominal embedment depth	h_{nom}	[mm]	h_{nom1}	h_{nom2}	h_{nom3}	h_{nom1}	h_{nom2}	h_{nom3}	h_{nom1}	h_{nom2}	h_{nom3}
			50	60	70	55	75	85	65	85	115
Thickness of fixture	t_{fix}	[mm]	t_{fix1}	t_{fix2}	t_{fix3}	t_{fix1}	t_{fix2}	t_{fix3}	t_{fix1}	t_{fix2}	t_{fix3}
			5	-	-	-	-	-	-	-	-
Length of screw [mm]	55		-	-	-	5	-	-	-	-	-
	60		-	-	-	5	-	-	-	-	-
	65		15	5	-	-	-	-	-	-	-
	70		-	-	-	15	-	-	-	-	-
	75		25	15	5	-	-	-	10	-	-
	80		-	-	-	25	5	-	-	-	-
	85		35	25	15	-	-	-	-	-	-
	90		-	-	-	35	15	5	-	-	-
	100		50	40	30	45	25	15	35	15	-
	110		-	-	-	55	35	25	-	-	-
	120		70	60	50	-	-	-	-	-	-
130		-	-	-	75	55	45	65	45	15	
150		100	90	80	95	75	65	85	65	35	

Setting

Setting details: depth of drill hole h_1 and effective anchorage depth h_{ef}

Setting details

Anchor size			8			10			14		
Type	HUS3-		H, HF			H, HF			H, HF		H
			h_{nom1}	h_{nom2}	h_{nom3}	h_{nom1}	h_{nom2}	h_{nom3}	h_{nom1}	h_{nom2}	h_{nom3}
Nominal anchorage depth	h_{nom}	[mm]	50	60	70	55	75	85	65	85	115
Minimum base material thickness	h_{min}	[mm]	100	115	145	115	150	175	130	175	255
Minimum spacing	s_{min}	[mm]	40	50	50	50	50	60	60	75	75
Minimum edge distance	c_{min}	[mm]	50	50	50	50	50	60	60	75	75
Nominal diameter of drill bit	d_o	[mm]	8			10			14		
Cutting diameter of drill bit	$d_{cut} \leq$	[mm]	8,45			10,45			14,50		
Clearance hole diameter	$d_f \leq$	[mm]	12			14			18		
Wrench size (H, HF-type)	SW	[mm]	13			15			21		
Diameter of countersunk head	d_h	[mm]	18			21			-		
Torx size (C-type)	TX	-	45			50			-		
Setting tool ¹⁾ for strength class C20/25			Hilti SIW 14 A or Hilti SIW 22 A or Hilti SIW 22 T-A ²⁾			Hilti SIW 22 A or Hilti SIW 22 T-A ²⁾			Hilti SIW 22 T-A ²⁾		

1) Installation with other impact screw driver of equivalent power is possible

2) Also for strength class >C20/25

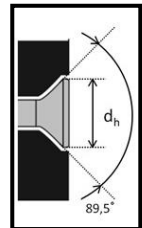
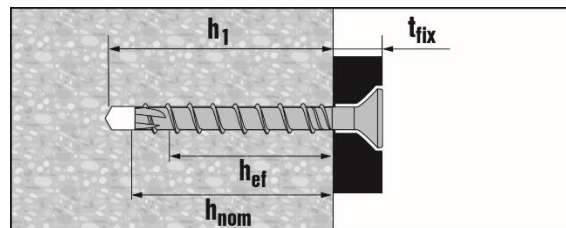
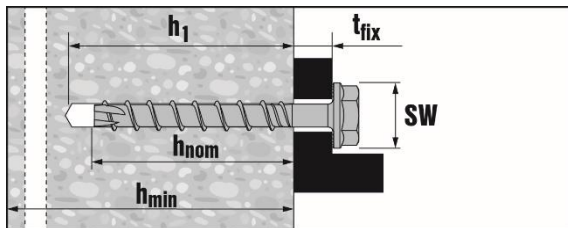

Anchor parameters

Anchor size		8			10			14		
Type	HUS3-	H, C, HF			H, C, HF			H, HF		H
Nominal anchorage depth	h_{nom} [mm]	h_{nom1}	h_{nom2}	h_{nom3}	h_{nom1}	h_{nom2}	h_{nom3}	h_{nom1}	h_{nom2}	h_{nom3}
		50	60	70	55	75	85	65	85	115
Effective anchorage depth	h_{ef} [mm]	40	46,4	54,9	41,6	58,6	67,1	49,3	66,3	91,8
Minimum base material thickness	h_{min} [mm]	100	100	120	100	130	140	120	160	200
Minimum spacing	s_{min} [mm]	40	50	50	50	50	60	60	75	75
Minimum edge distance	c_{min} [mm]	50	50	50	50	50	60	60	75	75
Critical spacing for splitting failure	$s_{cr,sp}$ [mm]	120	140	170	130	180	220	170	200	280
Critical edge distance for splitting failure	$c_{cr,sp}$ [mm]	60	70	85	65	90	110	85	100	140
Critical spacing for concrete cone failure	$s_{cr,N}$ [mm]	120	140	170	130	180	202	150	200	280
Critical edge distance for concrete cone failure	$c_{cr,N}$ [mm]	60	70	85	65	90	101	75	100	140

For spacing (edge distance) smaller than critical spacing (critical edge distance) the design loads have to be reduced.

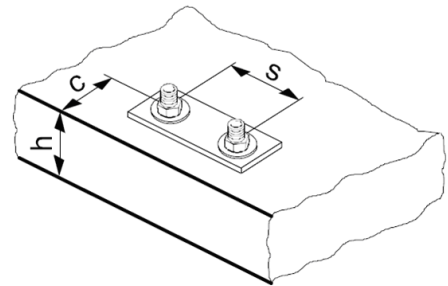

Setting instructions

*For detailed information on installation see instruction for use given with the package of the product.

Setting instruction without adjustment	
<p>1. Drilling</p>	<p>2. Cleaning</p>
<p>3. Inserting</p>	<p>4. Checking</p>
Setting instruction with adjustment	
<p>1.</p>	<p>2.</p>
<p>3.</p>	<p>4.</p>
<p>5.</p>	<p>6.</p>
<p>7.</p>	<p>8.</p>



The anchor can be adjusted max. two times.
 The total allowed thickness of shims added during the adjustment process is 10 mm.
 The final embedment depth after adjustment process must be larger or equal than h_{nom2} or h_{nom3} .

Installation instruction with Hilti seismic filling set for HUS3-H

<p>1.</p>	<p>2.</p>
<p>3.</p>	<p>4.</p>
<p>5.</p>	<p>6.</p>

Size		$t_{fix, effective}$ [mm]
Seismic Set	HUS3	
M12	10	8
M16	14	9



**1 Anchor technology and design
for seismic conditions**

page 4

**2 Anchor selector for seismic
conditions**

page 24

3 Mechanical anchors

page 30

4 Chemical anchors

page 76





Hilti HIT-HY 200-A (R) mortar with HIT-Z rod





Hilti HIT-HY 200-A (R) mortar with HIT-V rod

Hilti HIT-RE 500 V3 mortar with HIT-V rod

Hilti HIT-RE 500 V3 mortar with HIS-(R)N sleeve

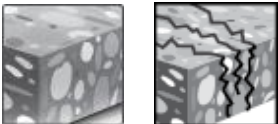
Hilti HIT-HY 200 A (R) mortar with HIT-Z rod

Injection mortar system		Benefits
 <p>Hilti HIT-HY 200-A 500 ml foil pack (also available as 330 ml foil pack)</p>	 <p>Hilti HIT-HY 200-R 500 ml foil pack (also available as 330 ml foil pack)</p>	<ul style="list-style-type: none"> - SafeSet technology: drilling and borehole cleaning in one step with Hilti hollow drill bit; no cleaning required for approved loads - unmatched seismic performance with the highest ETA C1 and C2 approvals - maximum load performance in cracked concrete and non-cracked concrete - suitable for cracked and non-cracked concrete C 20/25 to C 50/60 - suitable for use with diamond cored holes in non-cracked or cracked concrete with no load reductions - high loading capacity for cracked concrete - two mortar (Hilti HIT-HY 200-A and HILTI-HY 200-R) versions available with different curing times and same performance
 <p>Static mixer</p>		
 <p>HIT-Z HIT-Z-R rod</p>		

<p>Base material</p>  <p>Concrete (non-cracked) Concrete (cracked)</p>	<p>Installation conditions</p>  <p>Static/ quasi-static Seismic, ETA-C1, C2 Fire Resistance</p>
<p>Load conditions</p>  <p>Hammer drilled holes Hilti SafeSet technology</p>	<p>Other information</p>  <p>European Technical Assessment CE conformity PROFIS Anchor design Software</p>

Approvals / certificates

Description	Authority / Laboratory	No. / date of issue
European technical assessment ^{a)}	DIBt, Berlin	ETA-12/0006 / 2016-08-18
European technical assessment ^{a)}	DIBt, Berlin	ETA-12/0028 / 2016-08-18

a) All data given in this section according to ETA-12/0006 and ETA-12/0028, issue 2016-08-18.

Seismic resistance (for a single anchor)

All data in this section applies to:

- Correct setting (See setting instruction)
- No edge distance and spacing influence
- Steel failure
- Minimum base material thickness
- Concrete C 20/25, $f_{ck,cube} = 25 \text{ N/mm}^2$
- Temperature range I (min. base material temp. -40°C , max. long/short term base material temp.: $+24^\circ\text{C}/40^\circ\text{C}$)
- Installation temperature range $+5^\circ\text{C}$ to $+40^\circ\text{C}$
- $\alpha_{gap} = 1,0$ (using Hilti seismic filling set)

For hammer drilled holes and hammer drilled holes with Hilti hollow drill bit:

Effective anchorage depth for seismic C2

Anchor size		M8	M10	M12	M16	M20
Eff. Anchorage depth for pull-out resistance	$h_{ef} = l_{Helix}$ [mm]	-	-	60	96	100
Eff. Anchorage depth for concrete cone resistance	h_{ef} [mm]	-	-	110	145	180

Characteristic resistance in case of seismic performance category C2

Anchor size		M8	M10	M12	M16	M20
Tension $N_{Rk,seis}$	HIT-Z; HIT-Z-R [kN]	-	-	29,4	53,4	73,9
Shear $V_{Rk,seis}$	HIT-Z; HIT-Z-R	-	-	23,0	41,0	61,0

Design resistance in case of seismic performance category C2

Anchor size		M8	M10	M12	M16	M20
Tension $N_{Rd,seis}$	HIT-Z; HIT-Z-R [kN]	-	-	19,6	35,6	49,3
Shear $V_{Rd,seis}$	HIT-Z; HIT-Z-R	-	-	18,4	32,8	48,8

Effective anchorage depth for seismic C1

Anchor size		M8	M10	M12	M16	M20
Eff. Anchorage depth for pull-out resistance	$h_{ef} = l_{Helix}$ [mm]	50	60	60	96	100
Eff. Anchorage depth for concrete cone resistance	h_{ef} [mm]	70	90	110	145	180

Characteristic resistance in case of seismic performance category C1

Anchor size		M8	M10	M12	M16	M20
Tension $N_{Rk,seis}$	HIT-Z; HIT-Z-R [kN]	17,9	26,1	35,3	53,4	73,9
Shear $V_{Rk,seis}$	HIT-Z	7,0	17,0	16,0	28,0	45,0
	HIT-Z-R	8,0	19,0	22,0	31,0	48,0

Design resistance in case of seismic category C1

Anchor size		M8	M10	M12	M16	M20
Tension $N_{Rd,seis}$	HIT-Z; HIT-Z-R [kN]	11,9	17,4	23,5	35,6	49,3
Shear $V_{Rd,seis}$	HIT-Z	5,6	13,6	12,8	22,4	36,0
	HIT-Z-R	6,4	15,2	17,6	24,8	38,4

Static resistance (for a single anchor)

All data in this section applies to:

- Correct setting (See setting instruction with hammer drilling)
- No edge distance and spacing influence
- Steel failure
- Minimum base material thickness
- Concrete C 20/25, $f_{ck,cube} = 25 \text{ N/mm}^2$
- Temperature range I (min. base material temp. -40°C , max. long/short term base material temp.: $+24^\circ\text{C}/40^\circ\text{C}$)
- Installation temperature range $+5^\circ\text{C}$ to $+40^\circ\text{C}$

For hammer drilled holes, hammer drilled holes with Hilti hollow drill bit:

Effective anchorage depth for static

Anchor size			M8	M10	M12	M16	M20
Eff. Anchorage depth for pull-out resistance	$h_{ef} = l_{Helix}$	[mm]	50	60	60	96	100
Eff. Anchorage depth for concrete cone resistance	$h_{ef} = h_{nom,min}$	[mm]	70	90	110	145	180

Characteristic resistance in case of static performance

Anchor size			M8	M10	M12	M16	M20
Non-cracked concrete							
Tension N_{Rk}	HIT-Z; HIT-Z-R		24,0	38,0	54,3	88,2	122
Shear V_{Rk}	HIT-Z	[kN]	12,0	19,0	27,0	48,0	73,0
	HIT-Z-R		14,0	23,0	33,0	57,0	88,0
Cracked concrete							
Tension N_{Rk}	HIT-Z; HIT-Z-R		21,1	30,7	41,5	62,9	86,9
Shear V_{Rk}	HIT-Z	[kN]	12,0	19,0	27,0	48,0	73,0
	HIT-Z-R		14,0	23,0	33,0	57,0	88,0

Design resistance in case of static performance

Anchor size			M8	M10	M12	M16	M20
Non-cracked concrete							
Tension N_{Rd}	HIT-Z; HIT-Z-R		16,0	25,3	36,2	58,8	81,3
Shear V_{Rd}	HIT-Z	[kN]	9,6	15,2	21,6	38,4	58,4
	HIT-Z-R		11,2	18,4	26,4	45,6	70,4
Cracked concrete							
Tension N_{Rd}	HIT-Z; HIT-Z-R		14,1	20,5	27,7	41,9	58,0
Shear V_{Rd}	HIT-Z	[kN]	9,6	15,2	21,6	38,4	58,4
	HIT-Z-R		11,2	18,4	26,4	45,6	70,4

Materials

Mechanical properties of HIT-Z and HIT-Z-R

Anchor size		M8	M10	M12	M16	M20
Nominal tensile strength f_{uk}	HIT-Z HIT-Z-R [N/mm ²]	650	650	650	610	595
Yield strength f_{yk}	HIT-Z HIT-Z-R [N/mm ²]	520	520	520	490	480
Stressed cross- section of thread A_s	HIT-Z HIT-Z-R [mm ²]	36,6	58,0	84,3	157	245
Moment of resistance W	HIT-Z HIT-Z-R [mm ³]	31,9	62,5	109,7	278	542

Material quality for HIT-Z and HIT-Z-R

Part	Material
Threaded rod HIT-Z	C-steel cold formed Electroplated zinc coated $\geq 5 \mu\text{m}$
Washer	Electroplated zinc coated $\geq 5 \mu\text{m}$
Nut	Strength class of nut adapted to strength class of anchor rod. Electroplated zinc coated $\geq 5 \mu\text{m}$
Threaded rod HIT-Z-R	Stainless steel
Washer	Stainless steel A4
Nut	Strength class of nut adapted to strength class of anchor rod. Stainless steel

Materials of Hilti seismic filling set

Part	Material	
Sealing washer	Electroplated zinc coated $\geq 5\mu\text{m}$ or stainless steel	
Spherical washer		

Service temperature range

Hilti HIT-HY 200 A (R) injection mortar with anchor rod HIT-Z may be applied in the temperature ranges given below. An elevated base material temperature leads to a reduction of the design bond resistance.

Temperature range	Base material temperature	Maximum long term base material temperature	Maximum short term base material temperature
Temperature range I	-40 °C to +40 °C	+24 °C	+40 °C
Temperature range II	-40 °C to +80 °C	+50 °C	+80 °C
Temperature range III	-40 °C to +120 °C	+72 °C	+120 °C

Max short term base material temperature

Short-term elevated base material temperatures are those that occur over brief intervals, e.g. as a result of diurnal cycling.

Max long term base material temperature

Long-term elevated base material temperatures are roughly constant over significant periods of time.

Setting

Settings details HIT-Z and HIT-Z-R

Anchor size		M8	M10	M12	M16	M20
Nominal diameter of drill bit	d_0 [mm]	10	12	14	18	22
Nominal embedment depth range ^{a)}	$h_{nom,min}$ [mm]	60	60	60	96	100
	$h_{nom,max}$ [mm]	100	120	144	192	220
Borehole condition 1 Minimum base material thickness	h_{min} [mm]	$h_{nom} + 60$ mm			$h_{nom} + 100$ mm	
Borehole condition 2 Minimum base material thickness	h_{min} [mm]	$h_{nom} + 30$ mm ≥ 100 mm			$h_{nom} + 45$ mm ≥ 45 mm	
Pre-setting: Diameter of clearance hole in the fixture	d_f [mm]	9	12	14	18	22
Through-setting: Diameter of clearance hole in the fixture	d_f [mm]	11	14	16	20	24
Instal.torque moment ^{b)}	T_{inst} [Nm]	10	25	40	80	150
Critical spacing for splitting failure	$s_{cr,sp}$ [mm]	$2 c_{cr,sp}$				
Critical edge distance for splitting failure ^{c)}	$c_{cr,sp}$ [mm]	$1,5 \cdot h_{nom}$ for $h / h_{nom} \geq 2,35$				
		$6,2 h_{nom} - 2,0 h$ for $2,35 > h / h_{nom} > 1,35$				
		$3,5 h_{nom}$ for $h / h_{nom} \leq 1,35$				
Critical spacing for concrete cone failure	$s_{cr,N}$ [mm]	$2 c_{cr,N}$				
Critical edge distance concrete cone failure ^{d)}	$c_{cr,N}$ [mm]	$1,5 h_{nom}$				

For spacing (edge distance) smaller than critical spacing (critical edge distance) the design loads have to be reduced.

- $h_{nom,min} \leq h_{nom} \leq h_{nom,max}$ (h_{nom} : embedment depth)
- Recommended torque moment to avoid splitting failure during installation with minimum spacing and edge distance
- h : base material thickness ($h \geq h_{min}$)
- The critical edge distance for concrete cone failure depends on the embedment depth h_{ef} and the design bond resistance. The simplified formula given in this table is on the safe side.

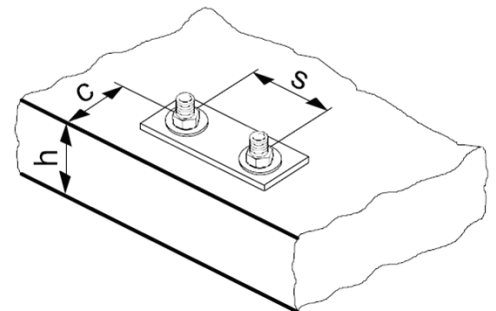

Anchor dimension

Anchor size		M8	M10	M12	M16	M20
Length of anchor	$\min l$	80	95	105	155	215
	$\max l$ [mm]	120	160	196	240	250
Helix length	l_{helix} [mm]	50	60	60	96	100

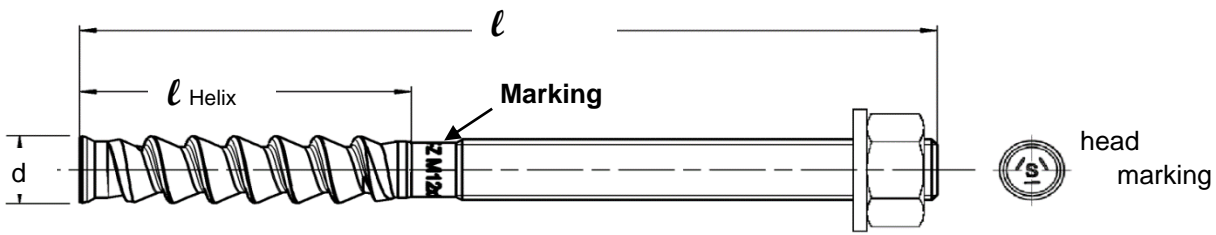

Minimum edge distance and spacing

For the calculation of minimum spacing and minimum edge distance of anchors in combination with different embedment depth and thickness of concrete member the following equation shall be fulfilled:

$$A_{i,req} < A_{i,cal}$$

Required interaction area $A_{i,cal}$

Anchor size		M8	M10	M12	M16	M20
Cracked concrete	[mm ²]	19200	40800	58800	94700	148000
Non-cracked concrete	[mm ²]	22200	57400	80800	128000	198000

Member thickness $h \geq h_{nom} + 1,5 \cdot c$

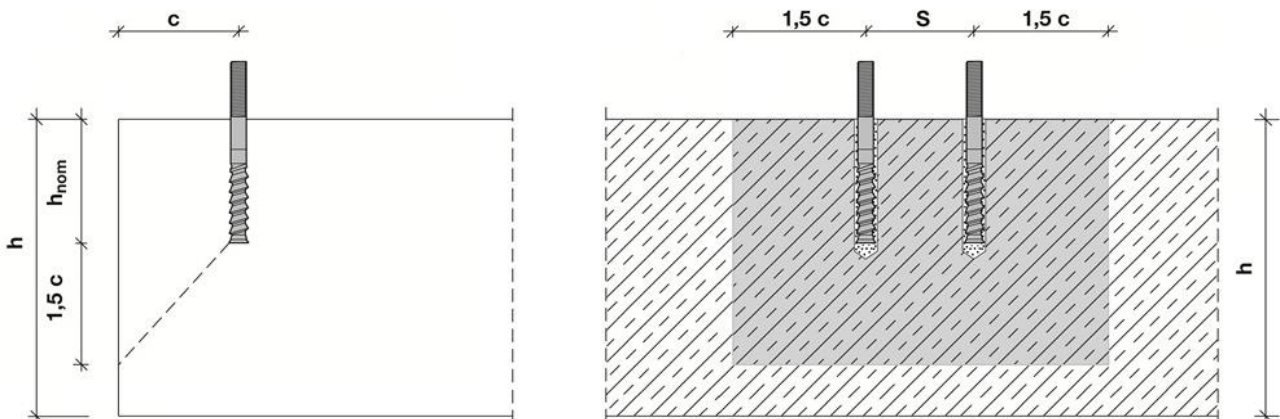

Single anchor and group of anchors with $s > 3 \cdot c$	[mm ²]	$A_{i,cal} = (6 \cdot c) \cdot (h_{nom} + 1,5 \cdot c)$	with $c \geq 5 \cdot d$
Group of anchors with $s \leq 3 \cdot c$	[mm ²]	$A_{i,cal} = (3 \cdot c + s) \cdot (h_{nom} + 1,5 \cdot c)$	with $c \geq 5 \cdot d$ and $s \geq 5 \cdot d$

Member thickness $h \leq h_{nom} + 1,5 \cdot c$

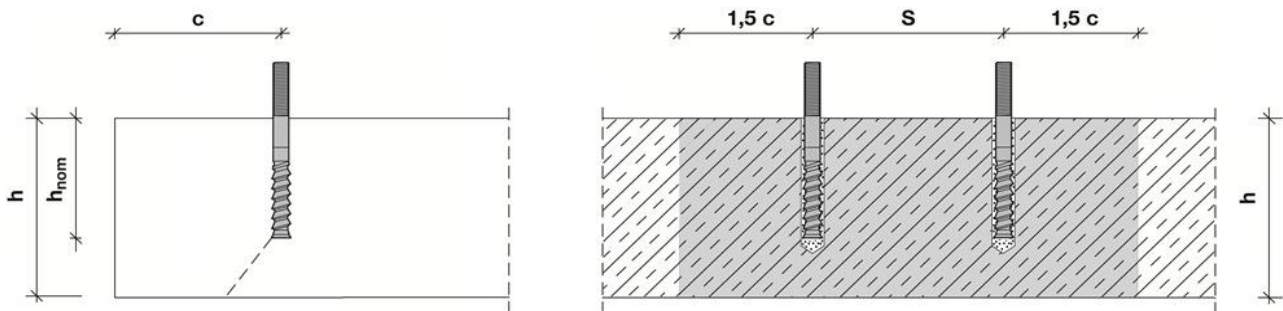

Single anchor and group of anchors with $s > 3 \cdot c$	[mm ²]	$A_{i,cal} = (6 \cdot c) \cdot h$	with $c \geq 5 \cdot d$
Group of anchors with $s \leq 3 \cdot c$	[mm ²]	$A_{i,cal} = (3 \cdot c + s) \cdot h$	with $c \geq 5 \cdot d$ and $s \geq 5 \cdot d$

Best case minimum edge distance and spacing with required member thickness and embedment depth

Anchor size		M8	M10	M12	M16	M20
Cracked concrete						
Member thickness	$h \geq$ [mm]	140	200	240	300	370
Embedment depth	$h_{nom} \geq$ [mm]	80	120	150	200	220
Minimum spacing	s_{min} [mm]	40	50	60	80	100
Corresponding edge distance	$c \geq$ [mm]	40	55	65	80	100
Minimum edge distance	$c_{min} =$ [mm]	40	50	60	80	100
Corresponding spacing	$s \geq$ [mm]	40	60	65	80	100
Non-cracked concrete						
Member thickness	$h \geq$ [mm]	140	230	270	340	410
Embedment depth	$h_{nom} \geq$ [mm]	80	120	150	200	220
Minimum spacing	s_{min} [mm]	40	50	60	80	100
Corresponding edge distance	$c \geq$ [mm]	40	70	80	100	130
Minimum edge distance	c_{min} [mm]	40	50	60	80	100
Corresponding spacing	$s \geq$ [mm]	40	145	160	160	235

Best case minimum member thickness and embedment depth with required minimum edge distance and spacing (borehole condition 1)

Anchor size		M8	M10	M12	M16	M20
Cracked concrete						
Member thickness	$h \geq$ [mm]	120	120	120	196	200
Embedment depth	$h_{nom} \geq$ [mm]	60	60	60	96	100
Minimum spacing	s_{min} [mm]	40	50	60	80	100
Corresponding edge distance	$c \geq$ [mm]	40	100	140	135	215
Minimum edge distance	$c_{min} =$ [mm]	40	60	90	80	125
Corresponding spacing	$s \geq$ [mm]	40	160	220	235	365
Non cracked concrete						
Member thickness	$h \geq$ [mm]	120	120	120	196	200
Embedment depth	$h_{nom} \geq$ [mm]	60	60	60	96	100
Minimum spacing	s_{min} [mm]	40	50	60	80	100
Corresponding edge distance	$c \geq$ [mm]	50	145	200	190	300
Minimum edge distance	c_{min} [mm]	40	80	115	110	165
Corresponding spacing	$s \geq$ [mm]	65	240	330	310	495

Minimum edge distance and spacing – Explanation

Minimum edge and spacing geometrical requirements are determined by testing the installation conditions in which two anchors with a given spacing can be set close to an edge without forming a crack in the concrete due to tightening torque.

The HIT-Z boundary conditions for edge and spacing geometry can be found in the tables to the left. If the embedment depth and slab thickness are equal to or greater than the values in the table, then the edge and spacing values may be utilized.

PROFIS Anchor software is programmed to calculate the referenced equations in order to determine the optimized related minimum edge and spacing based on the following variables:

<u>Cracked or non-cracked concrete</u>	For cracked concrete it is assumed that a reinforcement is present which limits the crack width to 0,3 mm, allowing smaller values for minimum edge distance and minimum spacing
<u>Anchor diameter</u>	For smaller anchor diameter a smaller installation torque is required, allowing smaller values for minimum edge distance and minimum spacing
<u>Slab thickness and embedment depth</u>	Increasing these values allows smaller values for minimum edge distance and minimum spacing



Curing and working time

Temperature of the base material	HIT-HY 200-R	
	Working time in which anchor can be inserted and adjusted t_{work}	Curing time before anchor can be loaded t_{cure}
5 °C	1 hour	4 hour
6 °C to 10 °C	40 min	2,5 hour
11 °C to 20 °C	15 min	1,5 hour
21 °C to 30 °C	9 min	1 hour
31 °C to 40 °C	6 min	1 hour

Curing and working time

Temperature of the base material	HIT-HY 200-A	
	Working time in which anchor can be inserted and adjusted t_{work}	Curing time before anchor can be loaded t_{cure}
5 °C	25 min	2 hour
6 °C to 10 °C	15 min	75 min
11 °C to 20 °C	7 min	45 min
21 °C to 30 °C	4 min	30 min
31 °C to 40 °C	3 min	30 min

Drilling diameters

Anchor rod HIT-Z / HIT-Z-R	Drill bit diameters d_0 [mm]	
	Hammer drill (HD)	Hollow Drill Bit (HDB)
		
M8	10	-
M10	12	12
M12	14	14
M16	18	18
M20	22	22

Installation equipment

Anchor size	M8	M10	M12	M16	M20
Rotary hammer	TE 2 – TE 40			TE 40 - TE 80	
Other tool	dispenser				
	Hilti hollow drill bit				

Setting instructions

*For detailed information on installation see instruction for use given with the package of the product.



Safety regulations.

Review the Material Safety Data Sheet (MSDS) before use for proper and safe handling! Wear well-fitting protective goggles and protective gloves when working with Hilti HIT-HY 200 A (R)

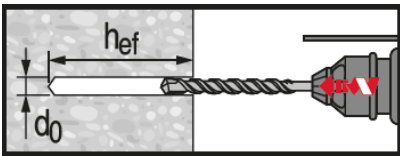

Hammer drilled hole (HD)

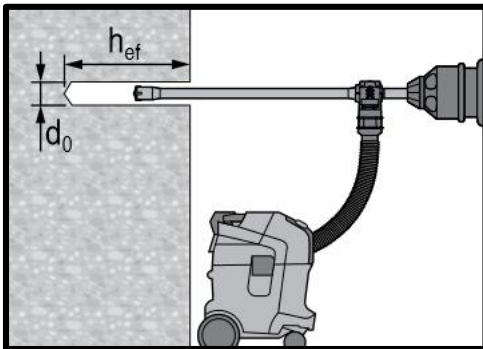

Hammer drilled hole with Hollow Drill Bit (HDB)

No cleaning required

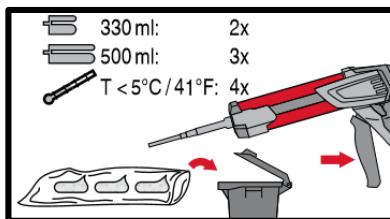
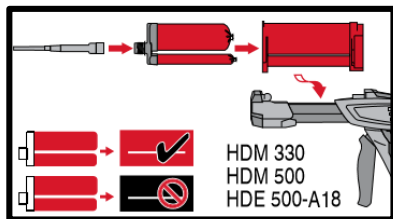

Injection system preparation.

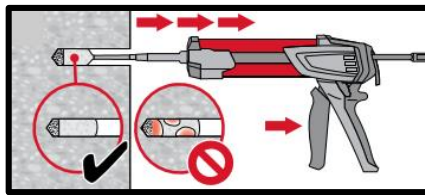
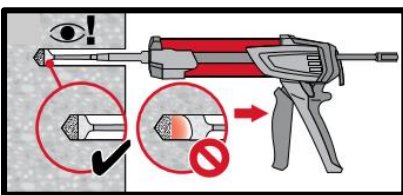

Injection method for drill hole depth $h_{ef} \leq 250$ mm.

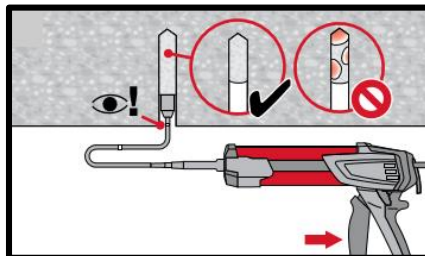
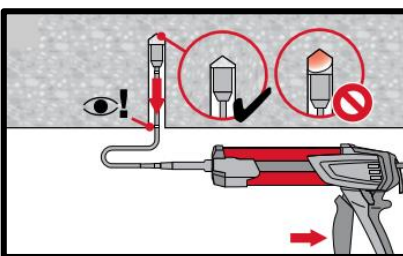

Injection method for overhead application.

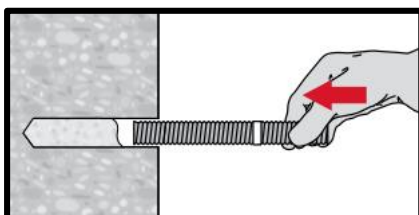

Setting element, observe working time "t_{work}".

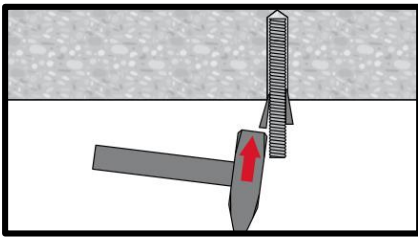

Setting element for overhead applications, observe working time " t_{work} ".

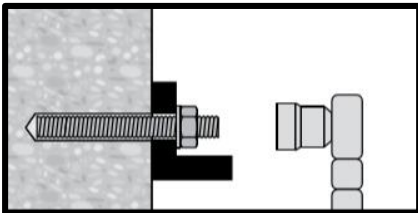







Loading the anchor: After required curing time t_{cure}

Installation with Hilti seismic filling set

<p>1</p> <p>t_{fix}</p> <p>HIT-Z(-R)</p>	<p>1a</p>
<p>2</p>	<p>3</p> <p>T_{inst}</p>
<p>4</p> <p>T_{max}</p> <p>HIT-Z(-R)</p>	<p>5</p>
<p>6</p> <p>$\frac{1}{4} - \frac{1}{2}$</p> <p>$t_{fix, effective}$</p>	<p>7</p> <p>HIT-HY 200 -A/-R</p>
<p>8</p> <p>1-3</p>	<p>9</p> <p>T_{cure}</p> <p>HIT-HY200 -A/-R</p>

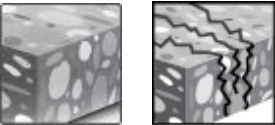
Hilti HIT-HY 200 A (R) mortar with HIT-V rod

Injection mortar system		Benefits
	<p>Hilti HIT-HY 200-A 330 ml foil pack (also available as 500 ml foil pack)</p>	<ul style="list-style-type: none"> - SafeSet technology: drilling and borehole cleaning in one step with Hilti hollow drill bit - Suitable for non-cracked and cracked concrete C 20/25 to C 50/60 - ETA Approved for seismic performance category C1, C2 - Maximum load performance in cracked concrete and non-cracked concrete - Small edge distance and anchor spacing possible - Large diameter applications - Manual cleaning for borehole diameter up to 20mm and $h_{ef} \leq 10d$ for non-cracked concrete only - Two mortar (A and R) versions available with different curing times and same performance
	<p>Hilti HIT-HY 200-R 330 ml foil pack (also available as 500 ml foil pack)</p>	
	<p>Static mixer</p>	
	<p>HIT-V rod AM 8.8</p>	

<p>Base material</p>  <p>Concrete (non-cracked) Concrete (cracked)</p>	<p>Installation conditions</p>  <p>Static/quasi-static Seismic, ETA-C1, C2 Fire resistance</p>
<p>Load conditions</p>  <p>Hammer drilled holes Hilti SafeSet technology</p>	<p>Other information</p>  <p>European Technical Assessment CE conformity PROFIS Anchor design Software</p>

Approvals / certificates

Description	Authority / Laboratory	No. / date of issue
European technical Assessment ^{a)}	DIBt, Berlin	ETA-11/0493/ 2017-02-03
European technical Assessment ^{a)}	DIBt, Berlin	ETA-12/0084/ 2017-02-03

a) All data given in this section according to ETA-11/0493, issue 2017-02-03 and ETA-12/0084, issue 2017-02-03.

Seismic resistance (for a single anchor)

All data in this section applies to:

- Correct setting (See setting instruction with hammer drilling)
- No edge distance and spacing influence
- Steel failure
- Minimum base material thickness
- Concrete C 20/25, $f_{ck,cube} = 25 \text{ N/mm}^2$
- Temperature range I (min. base material temp. -40°C , max. long/short term base material temp.: $+24^\circ\text{C}/40^\circ\text{C}$)
- Installation temperature range -10°C to $+40^\circ\text{C}$
- $\alpha_{gap} = 1,0$ (using Hilti seismic filling set)

For hammer drilled holes and hammer drilled holes with Hilti hollow drill bit:

Anchorage depth for seismic C2

Anchor size		M10	M12	M16	M20	M24	M27	M30
Embedment depth	h_{ef} [mm]	-	-	125	170	210	-	-

Characteristic resistance in case of seismic performance category C2

Anchor size		M10	M12	M16	M20	M24	M27	M30	
Tension $N_{Rk,seis}$	HIT-V 8.8, AM 8.8	[kN]	-	-	24,5	45,9	55,4	-	-
Shear $V_{Rk,seis}$	HIT-V 8.8, AM 8.8		-	-	46,0	77,0	103,0	-	-

Design resistance in case of seismic performance category C2

Anchor size		M10	M12	M16	M20	M24	M27	M30	
Tension $N_{Rd,seis}$	HIT-V 8.8, AM 8.8	[kN]	-	-	16,3	30,6	36,9	-	-
Shear $V_{Rd,seis}$	HIT-V 8.8, AM 8.8		-	-	36,8	61,6	82,4	-	-

Anchorage depth for seismic C1

Anchor size		M10	M12	M16	M20	M24	M27	M30
Embedment depth	h_{ef} [mm]	90	110	125	170	210	240	270

Characteristic resistance in case of seismic performance category C1

Anchor size		M10	M12	M16	M20	M24	M27	M30	
Tension $N_{Rk,seis}$	HIT-V 8.8, AM 8.8	[kN]	14,7	29,0	42,8	67,8	93,1	113,8	135,8
Shear $V_{Rk,seis}$	HIT-V 8.8, AM 8.8		23,0	34,0	63,0	98,0	141,0	184,0	224,0

Design resistance in case of seismic performance category C1

Anchor size		M10	M12	M16	M20	M24	M27	M30	
Tension $N_{Rd,seis}$	HIT-V 8.8, AM 8.8	[kN]	9,8	19,4	28,5	45,2	62,1	75,8	90,5
Shear $V_{Rd,seis}$	HIT-V 8.8, AM 8.8		18,4	27,2	50,4	78,4	112,8	147,2	179,2

Static resistance (for a single anchor)

All data in this section applies to:

- Correct setting (See setting instruction)
- No edge distance and spacing influence
- Steel failure
- Minimum base material thickness
- Concrete C 20/25, $f_{ck,cube} = 25 \text{ N/mm}^2$
- Temperature range I (min. base material temp. -40°C , max. long/short term base material temp.: $+24^\circ\text{C}/40^\circ\text{C}$)
- Installation temperature range -10°C to $+40^\circ\text{C}$

For hammer drilled holes, hammer drilled holes with Hilti hollow drill bit:

Anchorage depth for static

Anchor size	M10	M12	M16	M20	M24	M27	M30
Embedment depth [mm]	90	110	125	170	210	240	270

Characteristic resistance in case of static performance

Anchor size	M10	M12	M16	M20	M24	M27	M30	
Non-cracked concrete								
Tension N_{Rk}	HIT-V 8.8, AM 8.8	43,1	58,3	70,6	43,1	153,7	187,8	224,0
Shear V_{Rk}	HIT-V 8.8, AM 8.8	23,0	34,0	63,0	86,2	141,0	184,0	224,0
Cracked concrete								
Tension N_{Rk}	HIT-V 8.8, AM 8.8	21,2	35,2	50,3	79,8	109,6	133,9	159,7
Shear V_{Rk}	HIT-V 8.8, AM 8.8	23,0	34,0	63,0	98,0	141,0	184,0	224,0

Design resistance in case of static performance

Anchor size	M10	M12	M16	M20	M24	M27	M30	
Non-cracked concrete								
Tension N_{Rd}	HIT-V 8.8, AM 8.8	28,7	38,8	47,1	74,6	102,5	125,2	149,4
Shear V_{Rd}	HIT-V 8.8, AM 8.8	18,4	27,2	50,4	78,4	112,8	147,2	179,2
Cracked concrete								
Tension N_{Rd}	HIT-V 8.8, AM 8.8	14,1	23,5	33,5	53,2	73,0	89,2	106,5
Shear V_{Rd}	HIT-V 8.8, AM 8.8	18,4	27,2	50,4	78,4	112,8	147,2	179,2

Materials

Materials properties for HIT-V and AM 8.8

Anchor size	M10	M12	M16	M20	M24	M27	M30	
Nominal tensile strength f_{uk}	HIT-V 8.8, AM 8.8 [N/mm ²]	800	800	800	800	800	800	
Yield strength f_{yk}	HIT-V 8.8, AM 8.8 [N/mm ²]	640	640	640	640	640	640	
Stressed cross-section A_s	HIT-V, AM 8.8 [mm ²]	58,0	84,3	157	245	353	459	561
Moment of resistance W	HIT-V, AM 8.8 [mm ³]	62,3	109	277	541	935	1387	1874

Material quality for HIT-V and AM 8.8

Part	Material
Threaded rod HIT-V 8.8	Strength class 8.8, A5 > 12% ductile Electroplated zinc coated $\geq 5\mu\text{m}$ Hot dip galvanized $\geq 45\mu\text{m}$
Hilti Meter rod, AM 8.8	Strength class 8.8, $f_{yk} = 800\text{ N/mm}^2$, $f_{yk} = 640\text{ N/mm}^2$ Elongation at fracture($l_0=5d$)>12% ductile Electroplated zinc coated $\geq 5\mu\text{m}$
Washer	Electroplated zinc coated $\geq 5\mu\text{m}$, hot dip galvanized $\geq 45\mu\text{m}$
	Stainless steel 1.4401, 1.4404, 1.4578, 1.4571, 1.4439, 1.4362 EN 10088-1:2014
	High corrosion resistant steel 1.4529, 1.4565 EN 10088-1:2014
Nut	Strength class of nut adapted to strength class of threaded rod. Electroplated zinc coated $\geq 5\mu\text{m}$, hot dip galvanized $\geq 45\mu\text{m}$
	Strength class of nut adapted to strength class of threaded rod. Stainless steel 1.4401, 1.4404, 1.4578, 1.4571, 1.4439, 1.4362 EN 10088-1:2014
	Strength class of nut adapted to strength class of threaded rod. High corrosion resistant steel 1.4529, 1.4565 EN 10088-1:2014

Materials of Hilti seismic filling set

Part	Material	
Filling washer	Electroplated zinc coated $\geq 5\mu\text{m}$	
Spherical washer		
Lock nut		

Service temperature range

Hilti HIT-HY 200 A (R) injection mortar with anchor rod HIT-V may be applied in the temperature ranges given below. An elevated base material temperature leads to a reduction of the design bond resistance.

Temperature range	Base material temperature	Maximum long term base material temperature	Maximum short term base material temperature
Temperature range I	-40 °C to +40 °C	+24 °C	+40 °C
Temperature range II	-40 °C to +80 °C	+50 °C	+80 °C
Temperature range III	-40 °C to +120 °C	+72 °C	+120 °C

Max short term base material temperature

Short-term elevated base material temperatures are those that occur over brief intervals, e.g. as a result of diurnal cycling.

Max long term base material temperature

Long-term elevated base material temperatures are roughly constant over significant periods of time.

Setting

Setting details HIT-V and AM 8.8

Anchor size		M10	M12	M16	M20	M24	M27	M30
Nominal diameter of drill bit	d_0 [mm]	12	14	18	22	28	30	35
Eff. embedment depth and drill hole depth ^{a)}	$h_{ef,min}$ [mm]	60	70	80	90	96	108	120
	$h_{ef,max}$ [mm]	200	240	320	400	480	540	600
Minimum base material thickness	h_{min} [mm]	$h_{ef} + 30 \text{ mm}$ $\geq 100 \text{ mm}$		$h_{ef} + 2 d_0$				
Maximum Diameter of clearance hole in the fixture	d_f [mm]	12	14	18	22	26	30	33
Max. torque moment ^{b)}	T_{max} [Nm]	20	40	80	150	200	270	300
Minimum spacing	s_{min} [mm]	50	60	75	90	115	120	140
Minimum edge distance	c_{min} [mm]	45	45	50	55	60	75	80
Critical spacing for splitting failure	$s_{cr,sp}$ [mm]	$2 c_{cr,sp}$						
Critical edge distance for splitting failure ^{h)}	$c_{cr,sp}$ [mm]	$1,0 \cdot h_{ef}$ for $h / h_{ef} \geq 2,00$						
		$4,6 h_{ef} - 1,8 h$ for $2,00 > h / h_{ef} > 1,3$						
		$2,26 h_{ef}$ for $h / h_{ef} \leq 1,3$						
Critical spacing for concrete cone failure	$s_{cr,N}$ [mm]	$3,0 h_{ef}$						
Critical edge distance for concrete cone failure ^{d)}	$c_{cr,N}$ [mm]	$1,5 h_{ef}$						

For spacing (edge distance) smaller than critical spacing (critical edge distance) the design loads have to be reduced.

- a) $h_{ef,min} \leq h_{ef} \leq h_{ef,max}$ (h_{ef} : embedment depth)
- b) Maximum recommended torque moment to avoid splitting failure during Installation with minimum spacing and edge distance
- c) h : base material thickness ($h \geq h_{min}$)
- d) The critical edge distance for concrete cone failure depends on the embedment depth h_{ef} and the design bond resistance. The simplified formula given in this table is on the save side.

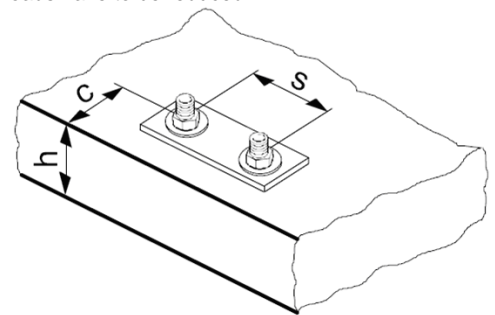





Curing and working time

Temperature of the base material	HIT-HY 200-A	
	Working time in which anchor can be inserted and adjusted t_{work}	Curing time before anchor can be loaded t_{cure}
-10°C to -5°C	1,5 hours	7 hours
> -5°C to 0°C	50 min	4 hours
> 0°C to 5°C	25 min	2 hours
> 5°C to 10°C	15 min	75 in
> 10°C to 20°C	7 min	45 min
> 20°C to 30°C	4 min	30 min
> 30°C to 40°C	3 min	30 min

Curing and working time

Temperature of the base material	HIT-HY 200-R	
	Working time in which anchor can be inserted and adjusted t_{work}	Curing time before anchor can be loaded t_{cure}
-10°C to -5°C	3 hours	20 hours
> -5°C to 0°C	2 hours	8 hours
> 0°C to 5°C	1 hour	4 hours
> 5°C to 10°C	40 min	2,5 hours
> 10°C to 20°C	15 min	1,5 hours
> 20°C to 30°C	9 min	1 hour
> 30°C to 40°C	6 min	1 hour

Drilling, cleaning and installation diameters

Anchor rod HIT-V AM 8.8	Drill bit diameters d_0 [mm]		Cleaning and installation	
	Hammer drill (HD)	Hollow Drill Bit (HDB)	Brush HIT-RB	Piston plug HIT-SZ
				
M8	10	-	10	-
M10	12	12	12	12
M12	14	14	14	14
M16	18	18	18	18
M20	22	22	22	22
M24	28	28	28	28
M27	30	-	30	30
M30	35	35	35	35

Installation equipment

Anchor size	M10	M12	M16	M20	M24	M27	M30
Rotary hammer	TE 2 – TE 16			TE 40 - TE 80			
Other tools	compressed air gun and blow out pump, set of cleaning brushes, dispenser						

Setting instructions

*For detailed information on installation see instruction for use given with the package of the product



Safety regulations.

Review the Material Safety Data Sheet (MSDS) before use for proper and safe handling! Wear well-fitting protective goggles and protective gloves when working with Hilti HIT-HY 200 A (R).

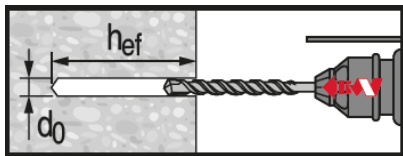

Hammer drilled hole (HD)

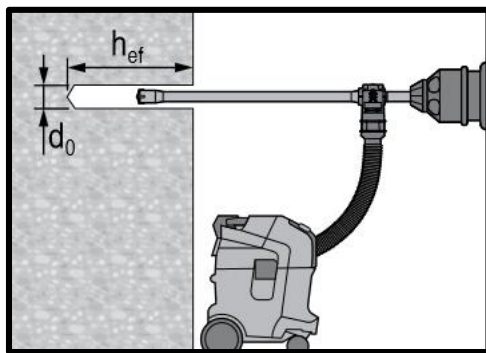

Hammer drilled hole with Hollow Drilled Bit (HDB)

No cleaning required

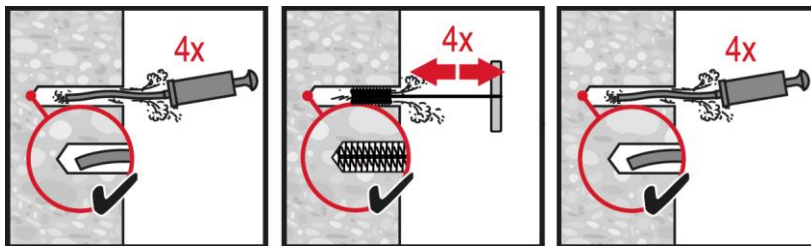

Manual cleaning (MC)

for drill diameters $d_0 \leq 20$ mm and drill hole depth $h_0 \leq 10 \cdot d$.

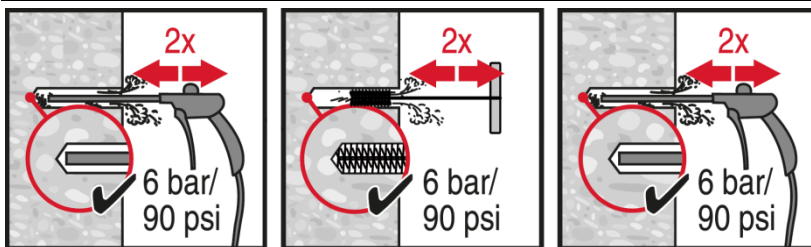

Compressed air cleaning (CAC)

for all drill hole diameters d_0 and drill hole depths $h_0 \leq 20 \cdot d$.

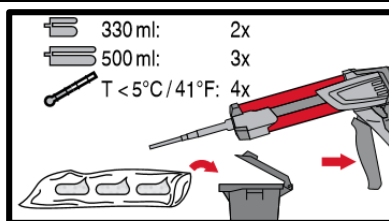
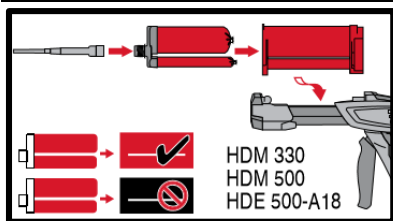

Injection system preparation.

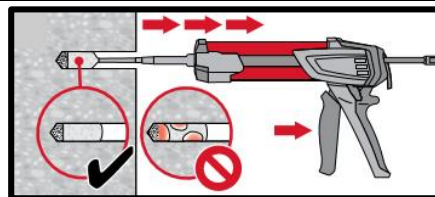
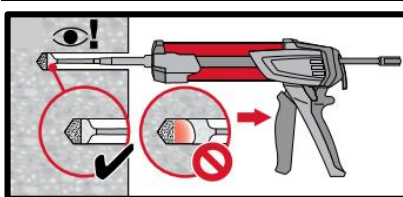

Injection method for drill hole depth $h_{ef} \leq 250$ mm.

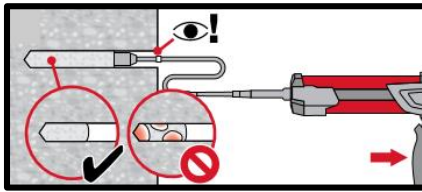
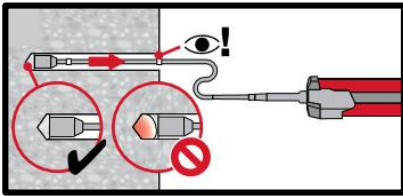

Injection method for drill hole depth $h_{ef} > 250\text{mm}$.

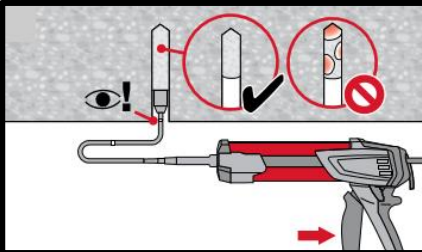
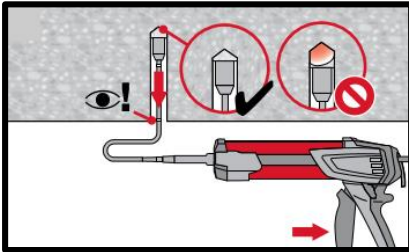

Injection method for overhead application.

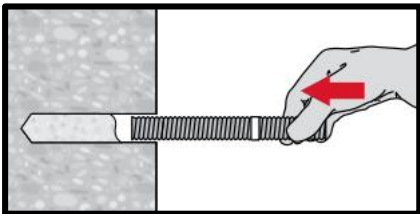

Setting element, observe working time " t_{work} ".

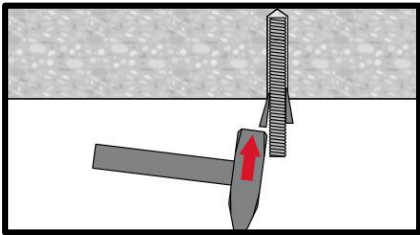

Setting element for overhead applications, observe working time " t_{work} ".

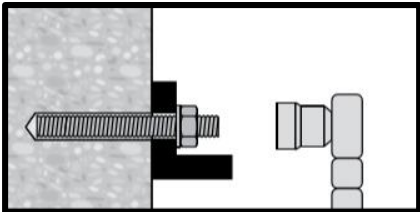





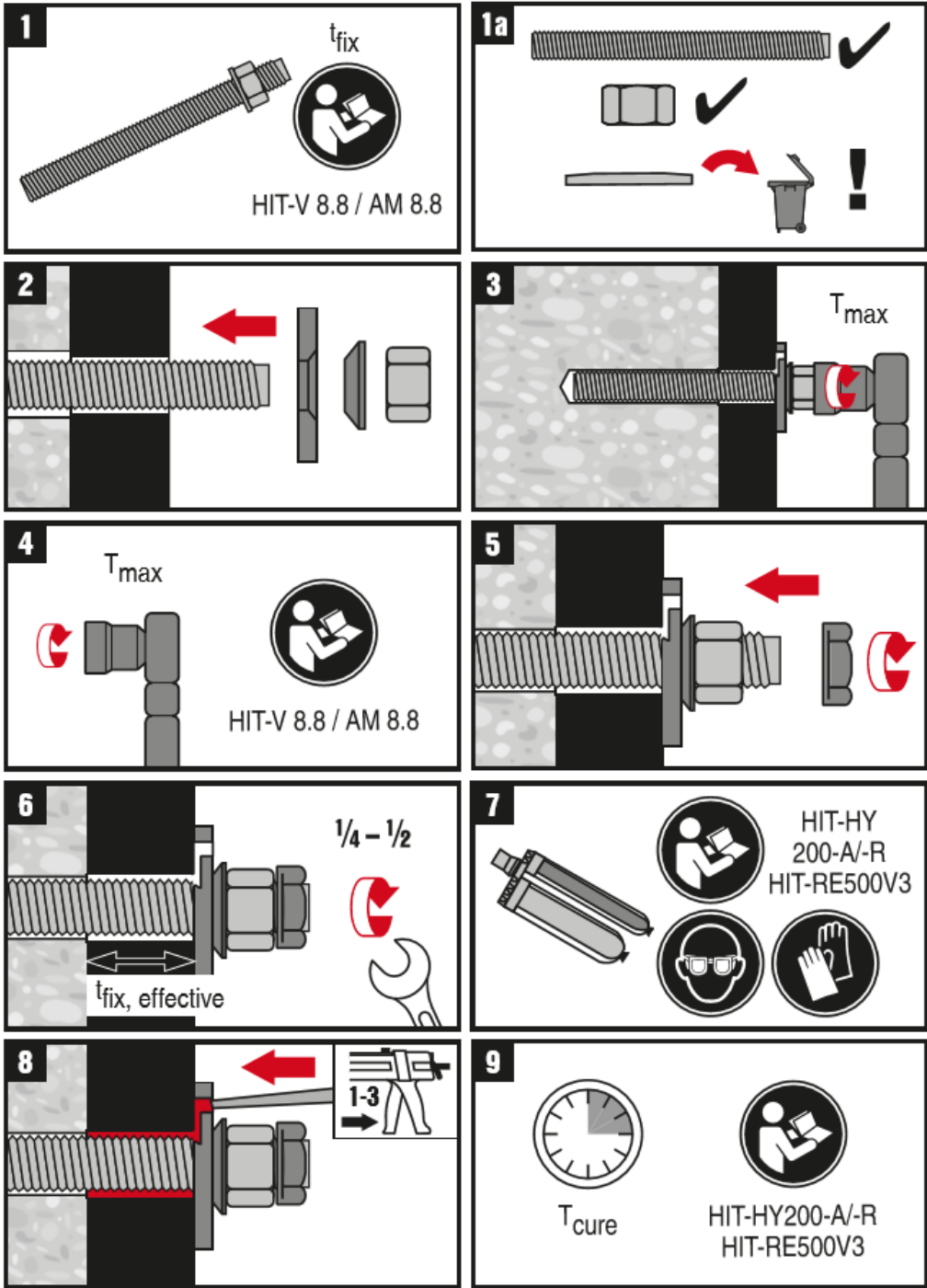





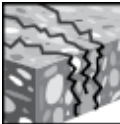

Loading the anchor: After required curing time t_{cure}

Installation with Seismic filling set (HIT-V and AM 8.8)



Hilti HIT-RE 500 V3 mortar with HIT-V rod

Injection mortar system		Benefits
	<p>Hilti HIT-RE V3 500 330 ml foil pack (also available as 500 ml and 1400 ml foil pack)</p>	<ul style="list-style-type: none"> - SafeSet technology: Hilti hollow drill bit for hammer drilling and Roughening tool for diamond coring - suitable for cracked/non-cracked concrete C 20/25 to C 50/60 - high loading capacity - suitable for dry and water saturated concrete - under water application - high corrosion resistance - long working time at elevated temperatures - odourless epoxy
	<p>Static mixer</p>	
	<p>HIT-V rod</p>	

<p>Base material</p>   <p>Concrete (non-cracked) Concrete (cracked)</p>	<p>Installation conditions</p>    <p>Static/ quasi-static Seismic, ETA- C1, C2 Fire resistance</p>
<p>Load conditions</p>   <p>Hammer drilled holes Diamond drilled holes</p> <p>SAFESET Hilti SafeSet technology</p>	<p>Other informations</p>    <p>European Technical Assessment CE conformity PROFIS Anchor design Software</p>

Approvals / certificates

Description	Authority / Laboratory	No. / date of issue
European Technical Assessment ^{a)}	CSBT, Marne-la-Vallée	ETA-16/0143 / 2016-11-30
Fire test report	MFPA Leipzig	GS 3.2/15-361-4 / 2016-08-04

a) All data given in this section according to ETA-16/0143, issue 2016-11-30.

Seismic resistance (for a single anchor)

All data in this section applies to:

- Correct setting (See setting instruction)
- No edge distance and spacing influence
- Steel failure
- Anchor HIT-V with strength class 5.8 and 8.8, anchor AM 8.8
- Minimum base material thickness
- Concrete C 20/25, $f_{ck,cube} = 25 \text{ N/mm}^2$
- Temperature range I (min. base material temp. -40°C , max. long/short term base material temp.: $+24^\circ\text{C}/40^\circ\text{C}$)
- Installation temperature range -5°C to $+40^\circ\text{C}$
- $\alpha_{gap} = 1,0$ (using Hilti seismic filling set)

For hammer drilled holes and hammer drilled holes with Hilti hollow drill bit:

Embedment depth and base material thickness for seismic C2

Anchor size	M8	M10	M12	M16	M20	M24	M27	M30
Eff. Anchorage depth [mm]	-	-	-	125	170	210	-	-
Base material thickness [mm]	-	-	-	165	220	270	-	-

Characteristic resistance in case of seismic performance category C2

Anchor size	M8	M10	M12	M16	M20	M24	M27	M30
Tensile N_{Rk} HIT-V 8.8, AM 8.8 [kN]	-	-	-	34,6	57,7	80,8	-	-
Shear V_{Rk} HIT-V 8.8, AM 8.8	-	-	-	46,0	77,0	103,0	-	-

Design resistance in case of seismic performance category C2

Anchor size	M8	M10	M12	M16	M20	M24	M27	M30
Tensile N_{Rd} HIT-V 8.8, AM 8.8 [kN]	-	-	-	23,0	38,5	53,8	-	-
Shear V_{Rd} HIT-V 8.8, AM 8.8	-	-	-	36,8	61,6	82,4	-	-

For hammer drilled holes, hammer drilled holes with Hilti hollow drill bit and diamond cored holes with roughening tool:

Embedment depth and base material thickness for seismic C1

Anchor size	M8	M10	M12	M16	M20	M24	M27	M30
Eff. Anchorage depth [mm]	80	90	110	125	170	210	240	270
Base material thickness [mm]	110	120	140	165	220	270	300	340

Characteristic resistance in case of seismic performance category C1

Anchor size	M8	M10	M12	M16	M20	M24	M27	M30
Tensile N_{Rk} HIT-V 8.8, AM 8.8 [kN]	12,1	19,8	32,8	42,8	67,8	93,1	113,8	135,8
Shear V_{Rk} HIT-V 8.8, AM 8.8	15,0	23,0	34,0	63,0	98,0	141,0	184,0	224,0

Design resistance in case of seismic performance category C1

Anchor size	M8	M10	M12	M16	M20	M24	M27	M30
Tensile N_{Rd} HIT-V 8.8, AM 8.8 [kN]	8,0	13,2	21,8	28,5	45,2	62,1	75,9	90,5
Shear V_{Rd} HIT-V 8.8, AM 8.8	12,0	18,4	27,2	50,4	78,4	112,8	147,2	179,2

Static resistance (for a single anchor)

All data in this section applies to:

- Correct setting
- No edge distance and spacing influence
- Steel failure
- Anchor HIT-V with strength class 5.8 and 8.8, anchor AM 8.8
- Minimum base material thickness
- Concrete C 20/25, $f_{ck,cube} = 25 \text{ N/mm}^2$
- Temperature range I (min. base material temperature -40°C , max. long/short term base material temperature: $+24^\circ\text{C}/40^\circ\text{C}$)
- Installation temperature range -5°C to $+40^\circ\text{C}$

For hammer drilled holes, hammer drilled holes with Hilti hollow drill bit¹⁾ and diamond cored holes with roughening tool²⁾:

Embedment depth and base material thickness

Anchor size		M8	M10	M12	M16	M20	M24	M27	M30
Eff. Anchorage depth	[mm]	80	90	110	125	170	210	240	270
Base material thickness	[mm]	110	120	140	161	214	266	300	340

Characteristic resistance

Anchor size		M8	M10	M12	M16	M20	M24	M27	M30
Non-cracked concrete									
Tensile N_{Rk}	HIT-V 8.8, AM 8.8	29,0	43,1	58,3	70,6	111,9	153,7	187,8	224,0
Shear V_{Rk}	HIT-V 8.8, AM 8.8	15,0	23,0	34,0	63,0	98,0	141,0	184,0	224,0
Cracked concrete									
Tensile N_{Rk}	HIT-V 8.8, AM 8.8	13,1	21,2	33,2	50,3	79,8	109,6	133,9	159,7
Shear V_{Rk}	HIT-V 8.8, AM 8.8	15,0	23,0	34,0	63,0	98,0	141,0	184,0	224,0

- 1) Hilti hollow drill bit available for element size M12-M30.
- 2) Roughening tools are available for element size M16-M30.

Design resistance

Anchor size		M8	M10	M12	M16	M20	M24	M27	M30
Non-cracked concrete									
Tensile N_{Rd}	HIT-V 8.8, AM 8.8	19,3	28,7	38,8	47,1	74,6	102,5	125,2	149,4
Shear V_{Rd}	HIT-V 8.8, AM 8.8	12,0	18,4	27,2	50,4	78,4	112,8	147,2	179,2
Cracked concrete									
Tensile N_{Rd}	HIT-V 8.8, AM 8.8	8,7	14,1	22,1	33,5	53,2	73,0	89,2	106,5
Shear V_{Rd}	HIT-V 8.8, AM 8.8	12,0	18,4	27,2	50,4	78,4	112,8	147,2	179,2

- 1) Hilti hollow drill bit available for element size M12-M30.
- 2) Roughening tools are available for element size M16-M30.

Materials

Mechanical properties for HIT-V and AM 8.8

Anchor size		M8	M10	M12	M16	M20	M24	M27	M30
Nominal tensile strength f_{uk}	HIT-V 8.8	800	800	800	800	800	800	800	800
	AM 8.8								
Yield strength f_{yk}	HIT-V 8.8	640	640	640	640	640	640	640	640
	AM 8.8								
Stressed cross-section A_s	HIT-V AM 8.8	36,6	58,0	84,3	157	245	353	459	561
Moment of resistance W	HIT-V AM 8.8	31,2	62,3	109	277	541	935	1387	1874

Material quality for HIT-V and AM 8.8

Part	Material
Threaded rod HIT-V 8.8	Strength class 8.8, A5 > 12% ductile Electroplated zinc coated $\geq 5\mu\text{m}$ Hot dip galvanized $\geq 45\mu\text{m}$
Hilti Meter rod AM 8.8	Strength class 8.8, A5 > 12% ductile Electroplated zinc coated $\geq 5\mu\text{m}$
Washer	Electroplated zinc coated $\geq 5\mu\text{m}$, hot dip galvanized $\geq 45\mu\text{m}$
	Stainless steel 1.4401, 1.4404, 1.4578, 1.4571, 1.4439, 1.4362 EN 10088-1:2014
	High corrosion resistant steel 1.4529, 1.4565 EN 10088-1:2014
Nut	Strength class of nut adapted to strength class of threaded rod. Electroplated zinc coated $\geq 5\mu\text{m}$, hot dip galvanized $\geq 45\mu\text{m}$
	Strength class of nut adapted to strength class of threaded rod. Stainless steel 1.4401, 1.4404, 1.4578, 1.4571, 1.4439, 1.4362 EN 10088-1:2014
	Strength class of nut adapted to strength class of threaded rod. High corrosion resistant steel 1.4529, 1.4565 EN 10088-1:2014

Materials of Hilti seismic filling set

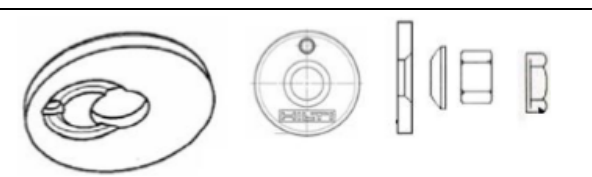
Part	Material	
Filling washer	Electroplated zinc coated $\geq 5\mu\text{m}$	
Spherical washer		
Lock nut		

Service temperature range

Hilti HIT-RE 500 V3 injection mortar may be applied in the temperature ranges given below. An elevated base material temperature may lead to a reduction of the design bond resistance.

Temperature range	Base material temperature	Maximum long term base material temperature	Maximum short term base material temperature
Temperature range I	-40 °C to +40 °C	+24 °C	+40 °C
Temperature range II	-40 °C to +70 °C	+43 °C	+70 °C

Max short term base material temperature

Short-term elevated base material temperatures are those that occur over brief intervals, e.g. as a result of diurnal cycling.

Max long term base material temperature

Long-term elevated base material temperatures are roughly constant over significant periods of time.

Setting

Setting details HIT-V and AM 8.8

Anchor size		M8	M10	M12	M16	M20	M24	M27	M30	
Nominal diameter of drill bit	d_0 [mm]	10	12	14	18	22	28	30	35	
Effective anchorage and drill hole depth range ^{a)}	$h_{ef,min}$ [mm]	60	60	70	80	90	96	108	120	
	$h_{ef,max}$ [mm]	160	200	240	320	400	480	540	600	
Minimum base material thickness	h_{min} [mm]	$h_{ef} + 30 \text{ mm}$ $\geq 100 \text{ mm}$			$h_{ef} + 2 d_0$					
Torque moment	T_{max} [Nm]	10	20	40	80	150	200	270	300	
Minimum spacing	s_{min} [mm]	40	50	60	75	90	115	120	140	
Minimum edge distance	c_{min} [mm]	40	45	45	50	55	60	75	80	
Critical spacing for splitting failure	$s_{cr,sp}$	$2 c_{cr,sp}$								
Critical edge distance for splitting failure ^{b)}	$c_{cr,sp}$ [mm]	$1,0 \cdot h_{ef}$ for $h / h_{ef} \geq 2,0$								
		$4,6 h_{ef} - 1,8 h$ for $2,0 > h / h_{ef} > 1,3$								
		$2,26 h_{ef}$ for $h / h_{ef} \leq 1,3$								
Critical spacing for concrete cone failure	$s_{cr,N}$	$2 c_{cr,N}$								
Critical edge distance for concrete cone failure ^{c)}	$c_{cr,N}$	$1,5 h_{ef}$								

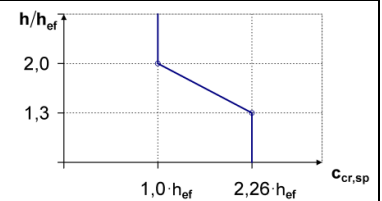

For spacing (edge distance) smaller than critical spacing (critical edge distance) the design loads have to be reduced.

- $h_{ef,min} \leq h_{ef} \leq h_{ef,max}$ (h_{ef} : embedment depth)
- Maximum recommended torque moment to avoid splitting failure during installation with minimum spacing and edge distance
- h : base material thickness ($h \geq h_{min}$)
- The critical edge distance for concrete cone failure depends on the embedment depth h_{ef} and the design bond resistance. The simplified formula given in this table is on the same side.

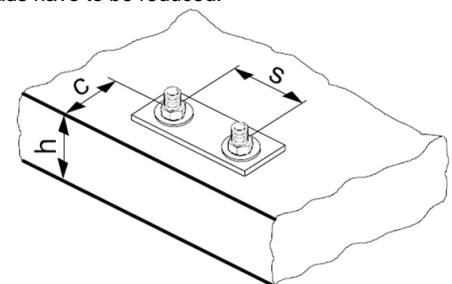





Curing time for general conditions

Temperature of the base material T	Minimum curing time $t_{\text{cure}}^{1)}$	Working time t_{work}
-5 °C to -1 °C	168 h	2 h
0 °C to 4 °C	48 h	2 h
5 °C to 9 °C	24 h	2 h
10 °C to 14 °C	16 h	1,5 h
15 °C to 19 °C	16 h	1 h
20 °C to 24 °C	7 h	30 min
25 °C to 29 °C	6 h	20 min
30 °C to 34 °C	5 h	15 min
35 °C to 39 °C	4,5 h	12 min
40 °C	4 h	10 min

1) The curing time data are valid for dry base material only. In wet base material the curing times must be doubled.

Drilling, cleaning and installation diameters

Threaded rod HIT-V AM 8.8	Drill bit diameters d_0 [mm]		Cleaning and installation	
	Hammer drill (HD)	Hollow Drill Bit (HDBw)	Brush HIT-RB	Piston plug HIT-SZ
				
M8	10	-	10	-
M10	12	-	12	12
M12	14	14	14	14
M16	18	18	18	18
M20	22	22	22	22
M24	28	28	28	28
M27	30	-	30	30
M30	35	35	35	35

Installation equipment

Anchor size	M8	M10	M12	M16	M20	M24	M27	M30
Rotary hammer	TE 2 – TE 16				TE 40 – TE 80			
Other tools	compressed air gun, set of cleaning brushes, dispenser							

Setting instructions

*For detailed information on installation see instruction for use given with the package of the product.



Safety regulations.

Review the Material Safety Data Sheet (MSDS) before use for proper and safe handling! Wear well-fitting protective goggles and protective gloves when working with Hilti HIT-RE 500 V3.

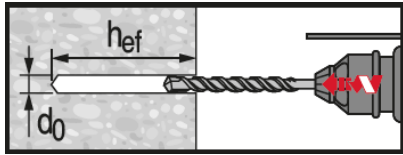

Hammer drilled hole (HD)

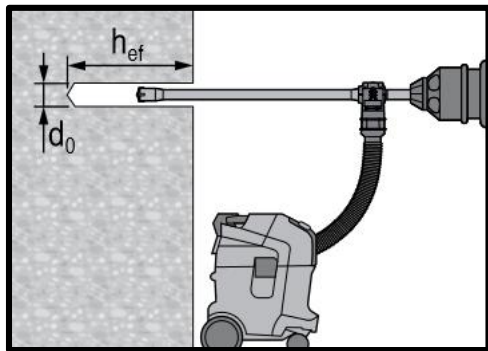

Hammer drilled hole with Hollow Drilled Bit (HDB)

No cleaning required

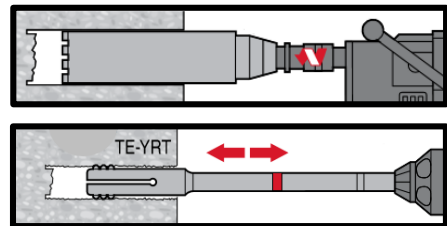

Diamond Drilling + Roughening Tool (DD+RT)

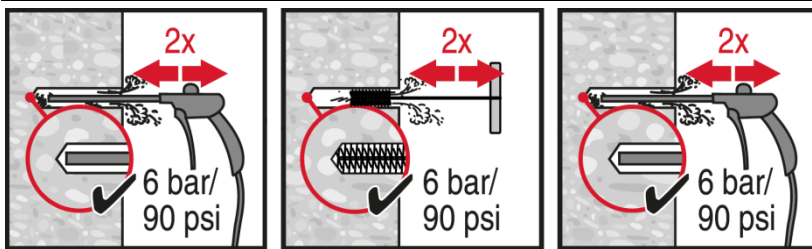

Hammer Drilling:

Compressed air cleaning (CAC)

for all drill hole diameters d_0 and drill hole depths $h_0 \leq 20 \cdot d$.

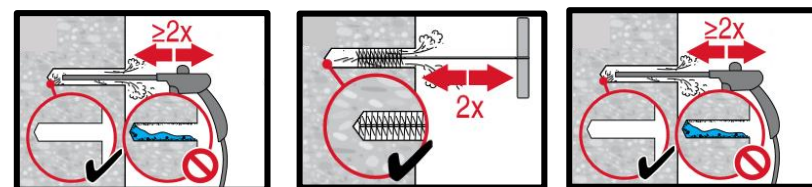

Diamond cored holes with Hilti roughening tool:

Compressed air cleaning (CAC)

for all diameters d_0 and drill hole depths h_0 .

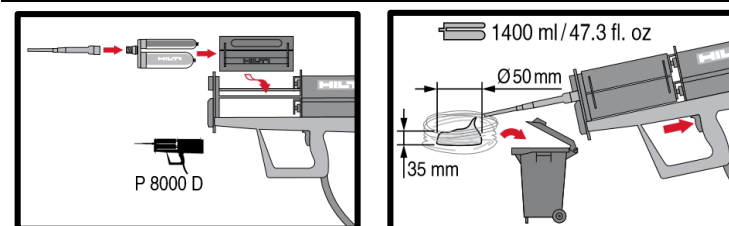

Injection system preparation.

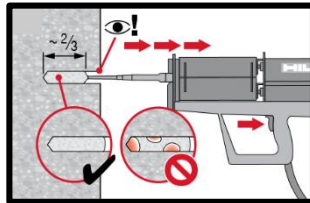
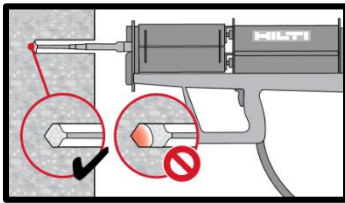

Injection method for drill hole depth $h_{ef} \leq 250 \text{ mm}$.

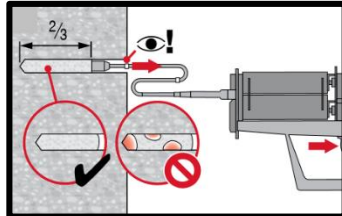
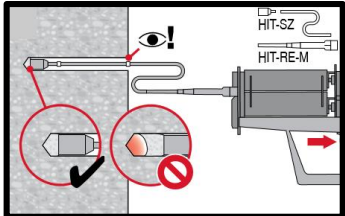

Injection method for drill hole depth $h_{ef} > 250 \text{ mm}$.

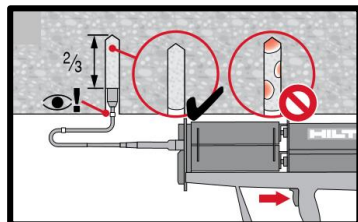
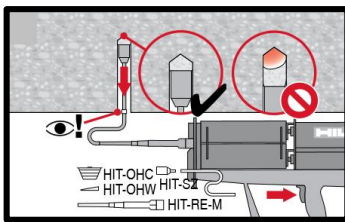

Injection method for overhead application.

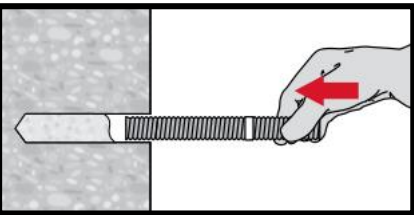

Setting element, observe working time t_{work} .

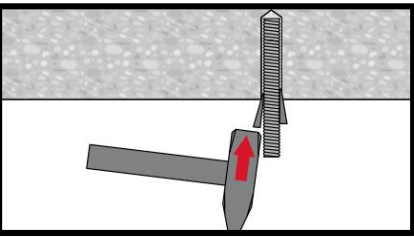

Setting element for overhead applications, observe working time t_{work} .

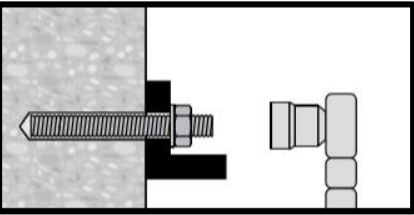





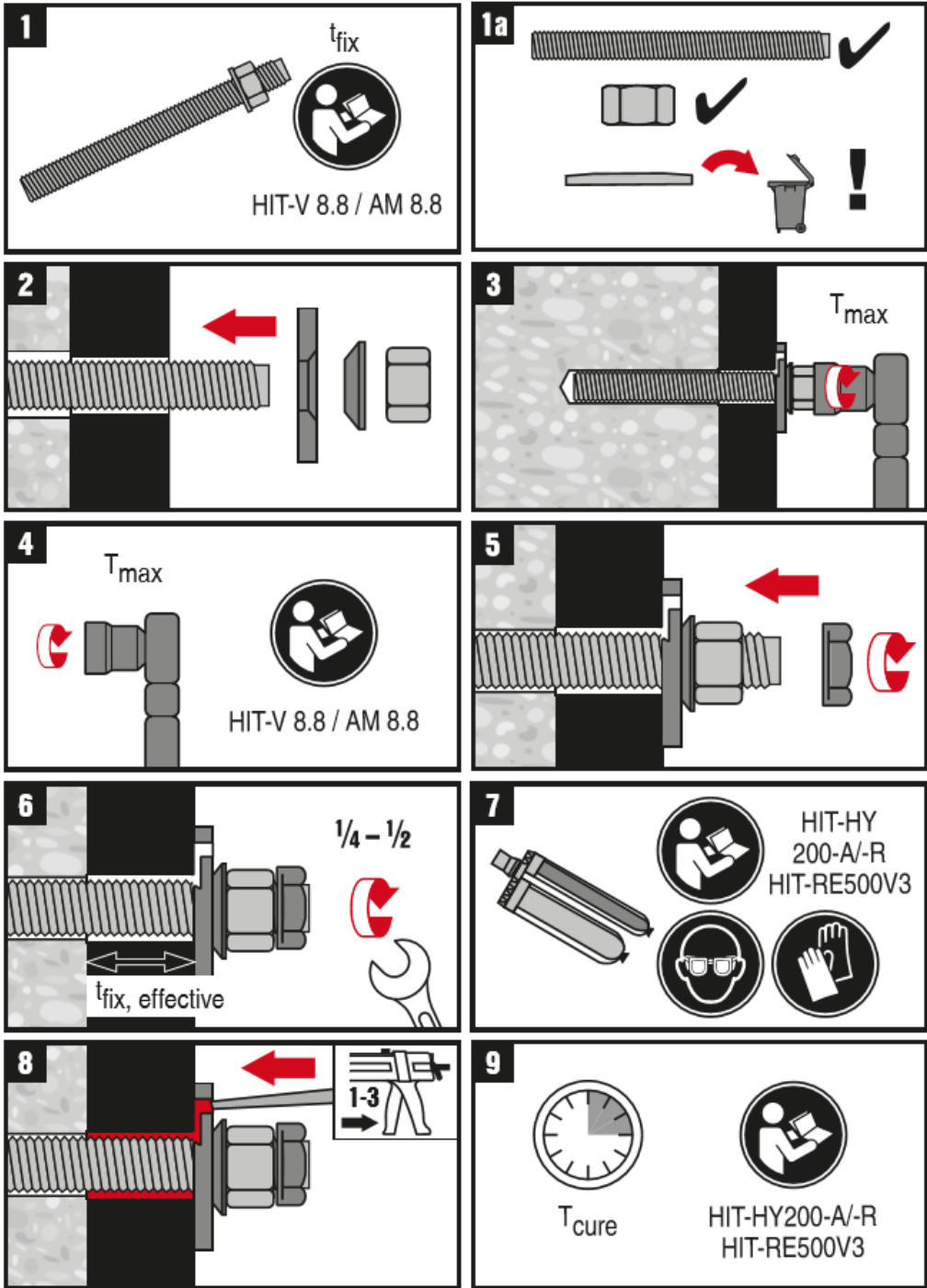





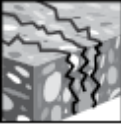
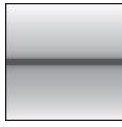

Loading the anchor: After required curing time t_{cure}

Installation with Seismic filling set (HIT-V and AM 8.8)

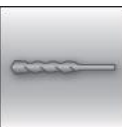

Hilti HIT-RE 500 V3 mortar with HIS-(R)N sleeve

Injection mortar system		Benefits
	Hilti HIT-RE 500 V3 330 ml, 500 ml and 1400 ml foil pack	<ul style="list-style-type: none"> - SafeSet technology: Hilti hollow drill bit for hammer drilling and roughening tool for diamond drilling - suitable for cracked/non-cracked concrete C 20/25 to C 50/60 - high loading capacity - suitable for dry and water saturated concrete - under water application for hammer drilled holes - long working time at elevated temperatures - odourless epoxy
	Static mixer	
	HIS-(R)N sleeve	

Base material   Concrete (non-cracked) Concrete (cracked)	Installation conditions    Static/quasi-static Seismic, ETA-C1 Fire resistance
Load conditions    Hammer drilled holes Diamond drilled holes Hilti SafeSet technology	Other information    European Technical Assessment CE conformity PROFIS Anchor design Software

Approvals / certificates

Description	Authority / Laboratory	No. / date of issue
European Technical Assessment ^{a)}	CSBT, Marne-la-Vallée	ETA-16/0143 / 2016-11-30

a) All data given in this section according to ETA-16/0143, issue 2016-07-28.

Seismic resistance (for a single anchor)

All data in this section applies to:

- Correct setting (See setting instruction)
- No edge distance and spacing influence
- **Steel** failure
- Screw strength class 8.8
- Minimum base material thickness
- Concrete C 20/25, $f_{ck,cube} = 25 \text{ N/mm}^2$
- Temperature range I (min. base material temp. -40°C , max. long/short term base material temp.: $+24^\circ\text{C}/40^\circ\text{C}$)
- Installation temperature range -5°C to $+40^\circ\text{C}$
- $\alpha_{gap} = 1,0$ (using Hilti seismic filling set)

For hammer drilled holes, hammer drilled holes with Hilti hollow drill bit and diamond cored holes with Hilti roughening tool:

Effective anchorage depth for seismic C1

Anchor size			M8	M10	M12	M16	M20
Eff. Anchorage depth	h_{ef}	[mm]	90	110	125	170	205

Characteristic resistance in case of seismic performance category C1

Anchor size			M8	M10	M12	M16	M20
Tensile $N_{Rk,seis}$	HIS-(R)N	[kN]	25,0	35,3	42,8	67,8	89,8
Shear $V_{Rk,seis}$	HIS-(R)N		9,0	16,0	24,0	44,0	41,0

Design resistance in case of seismic performance category C1

Anchor size			M8	M10	M12	M16	M20
Tensile $N_{Rd,seis}$	HIS-(R)N	[kN]	16,7	23,5	28,5	45,2	59,9
Shear $V_{Rd,seis}$	HIS-(R)N		7,2	12,8	19,2	35,2	32,8

Static resistance (for a single anchor)

All data in this section applies to:

- Correct setting (See setting instruction with hammer drilling)
- No edge distance and spacing influence
- **Steel** failure
- Screw strength class 8.8
- Minimum base material thickness
- Concrete C 20/25, $f_{ck,cube} = 25 \text{ N/mm}^2$
- Temperature range I (min. base material temperature -40°C , max. long/short term base material temperature: $+24^\circ\text{C}/40^\circ\text{C}$)
- Installation temperature range -5°C to $+40^\circ\text{C}$

For hammer drilled holes and hammer drilled holes with Hilti hollow drill bit:

Effective anchorage depth for static

Anchor size			M8	M10	M12	M16	M20
Eff. Anchorage depth	h_{ef}	[mm]	90	110	125	170	205

Characteristic resistance in case of static performance

Anchor size		M8	M10	M12	M16	M20
Non cracked concrete						
Tensile N_{Rk}	HIS-(R)N	25,0	46,0	67,0	111,9	116,0
Shear V_{Rk}	HIS-(R)N	13,0	23,0	34,0	63,0	58,0
Cracked concrete						
Tensile N_{Rk}	HIS-(R)N	25,0	41,5	50,3	79,8	105,7
Shear V_{Rk}	HIS-(R)N	13,0	23,0	34,0	63,0	58,0

Design resistance in case of static performance

Anchor size		M8	M10	M12	M16	M20
Non cracked concrete						
Tensile N_{Rd}	HIS-(R)N	16,7	30,7	44,7	74,6	77,3
Shear V_{Rd}	HIS-(R)N	10,4	18,4	27,2	50,4	46,4
Cracked concrete						
Tensile N_{Rd}	HIS-(R)N	16,7	27,7	33,5	53,2	70,4
Shear V_{Rd}	HIS-(R)N	10,4	18,4	27,2	50,4	46,4

Materials

Mechanical properties for HIS-(R) N

Anchor size		M8	M10	M12	M16	M20
Nominal tensile strength f_{uk}	HIS-N	490	490	460	460	460
	Screw 8.8	800	800	800	800	800
	HIS-RN	700	700	700	700	700
	Screw A4-70	700	700	700	700	700
Yield strength f_{yk}	HIS-N	410	410	375	375	375
	Screw 8.8	640	640	640	640	640
	HIS-RN	350	350	350	350	350
	Screw A4-70	450	450	450	450	450
Stressed cross-section A_s	HIS-(R)N	51,5	108,0	169,1	256,1	237,6
	Screw	36,6	58	84,3	157	245
Moment of resistance W	HIS-(R)N	145	430	840	1595	1543
	Screw	31,2	62,3	109	277	541

Material quality

Part	Material
internally threaded sleeves ^{a)} HIS-N	C-steel 1.0718, steel galvanized $\geq 5\mu\text{m}$
internally threaded sleeves ^{b)} HIS-RN	stainless steel 1.4401 and 1.4571

a) related fastening screw: strength class 8.8, A5 > 8% Ductile steel galvanized $\geq 5\mu\text{m}$

b) related fastening screw: strength class 70, A5 > 8% Ductile stainless steel 1.4401; 1.4404; 1.4578; 1.4571; 1.4439; 1.4362

Materials of Hilti seismic filling set

Part	Material	
Filling washer	Electroplated zinc coated $\geq 5\mu\text{m}$	
Spherical washer		
Lock nut		

Service temperature range

Hilti HIT-RE 500 V3 injection mortar may be applied in the temperature ranges given below. An elevated base material temperature may lead to a reduction of the design bond resistance.

Temperature range	Base material temperature	Maximum long term base material temperature	Maximum short term base material temperature
Temperature range I	-40 °C to +40 °C	+24 °C	+40 °C
Temperature range II	-43 °C to +70 °C	+43 °C	+70 °C

Max short term base material temperature

Short-term elevated base material temperatures are those that occur over brief intervals, e.g. as a result of diurnal cycling.

Max long term base material temperature

Long-term elevated base material temperatures are roughly constant over significant periods of time.

Setting

Setting details

Anchor size		M8	M10	M12	M16	M20
Nominal diameter of drill bit	d_0 [mm]	14	18	22	28	32
Diameter of element	d [mm]	12,5	16,5	20,5	25,4	27,6
Effective anchorage and drill hole depth	h_{ef} [mm]	90	110	125	170	205
Minimum base material thickness	h_{min} [mm]	120	150	170	230	270
Diameter of clearance hole in the fixture	d_f [mm]	9	12	14	18	22
Thread engagement length; min - max	h_s [mm]	8-20	10-25	12-30	16-40	20-50
Minimum spacing	s_{min} [mm]	60	70	90	115	130
Minimum edge distance	c_{min} [mm]	40	45	55	65	90
Critical spacing for splitting failure	$s_{cr,sp}$ [mm]	$2 C_{cr,sp}$				
Critical edge distance for splitting failure ^{b)}	$c_{cr,sp}$ [mm]	$1,0 \cdot h_{ef}$ for $h / h_{ef} \geq 2,0$				
		$4,6 h_{ef} - 1,8 h$ for $2,0 > h / h_{ef} > 1,3$				
		$2,26 h_{ef}$ for $h / h_{ef} \leq 1,3$				
Critical spacing for concrete cone failure	$s_{cr,N}$ [mm]	$2 C_{cr,N}$				
Critical edge distance for concrete cone failure ^{c)}	$c_{cr,N}$ [mm]	$1,5 h_{ef}$				
Max. torque moment ^{a)}	T_{max} [Nm]	10	20	40	80	150

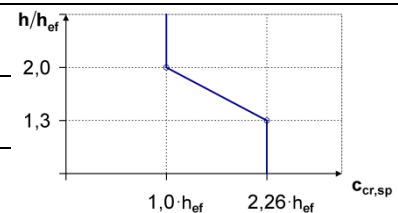

For spacing (edge distance) smaller than critical spacing (critical edge distance) the design loads have to be reduced.

- a) Max. recommended torque moment to avoid splitting failure during installation with minimum spacing and edge distance
- b) h : base material thickness ($h \geq h_{min}$)
- c) The critical edge distance for concrete cone failure depends on the embedment depth h_{ef} and the design bond resistance. The simplified formula given in this table is on the safe side.

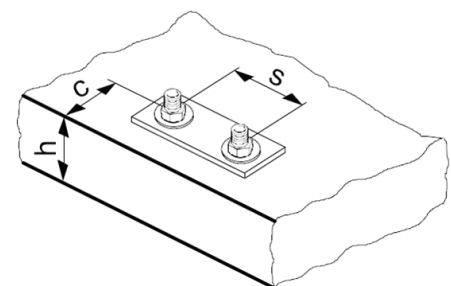





Curing time for general conditions

Temperature of the base material T	Working time t_{work}	Minimum curing time $t_{cure}^{1)}$
-5 °C to -1 °C	2 h	168 h
0 °C to 4 °C	2 h	48 h
5 °C to 9 °C	2 h	24 h
10 °C to 14 °C	1,5 h	16 h
15 °C to 19 °C	1 h	16 h
20 °C to 24 °C	30 min	7 h
25 °C to 29 °C	20 min	6 h
30 °C to 34 °C	15 min	5 h
35 °C to 39 °C	12 min	4,5 h
40 °C	10 min	4 h

The curing time data are valid for dry base material only. In wet base material the curing times must be doubled.

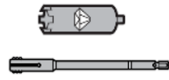
Parameters of cleaning and setting tools

HIS-(R)-N	Drill bit diameters d_0 [mm]			Cleaning and installation	
	Hammer drill (HD)	Hollow Drill Bit (HDB)	Diamond drilling with roughening tool (DD+RT)	Brush HIT-RB	Piston plug HIT-SZ
					
M8	14	14	-	14	14
M10	18	18	18	18	18
M12	22	22	22	22	22
M16	28	28	28	28	28
M20	32	32	32	32	32

Installation equipment

Anchor size	M8	M10	M12	M16	M20
Rotary hammer	TE 2 – TE 16		TE 40 – TE 80		
Other tools	compressed air gun, set of cleaning brushes, dispenser				

Setting instructions

*For detailed information on installation see instruction for use given with the package of the product.



Safety regulations.

Review the Material Safety Data Sheet (MSDS) before use for proper and safe handling! Wear well-fitting protective goggles and protective gloves when working with Hilti HIT-RE 500 V3.

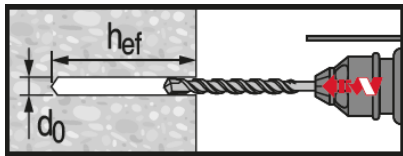

Hammer drilled hole (HD)

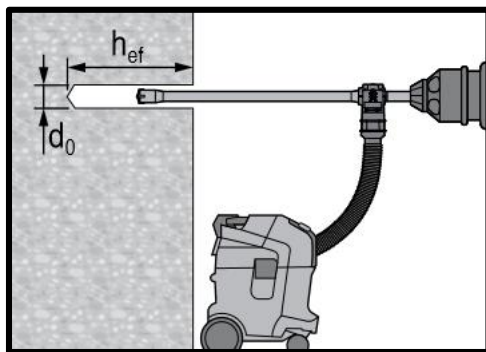

Hammer drilled hole with Hollow Drilled Bit (HDB)

No cleaning required

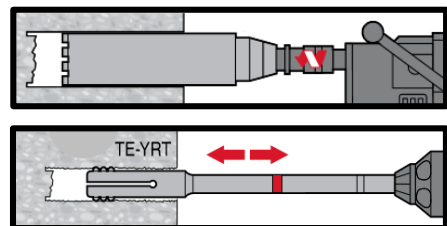

Diamond Drilling + Roughening Tool (DD+RT)

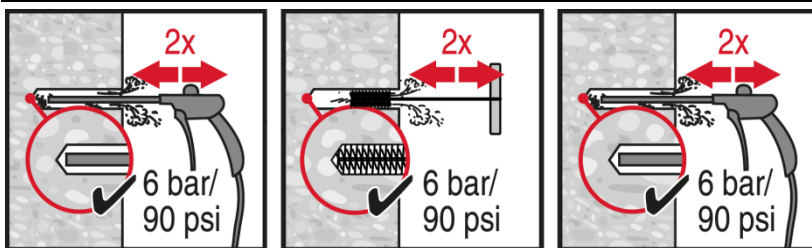

Hammer Drilling:

Compressed air cleaning (CAC)

for all drill hole diameters d_0 and drill hole depths $h_0 \leq 20 \cdot d$.

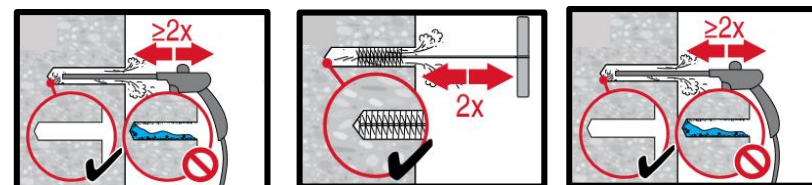

Diamond cored holes with Hilti roughening tool:

Compressed air cleaning (CAC)

for all drill hole diameters d_0 and drill hole depths h_0 .

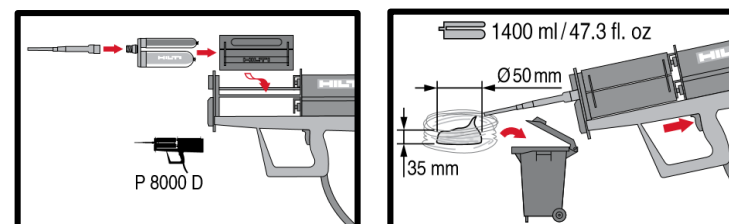

Injection system preparation.

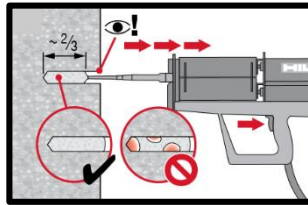
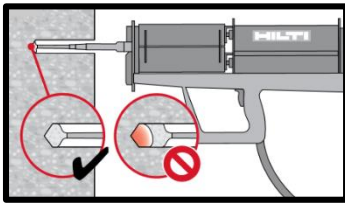

Injection method for drill hole depth
 $h_{ef} \leq 250 \text{ mm}$.

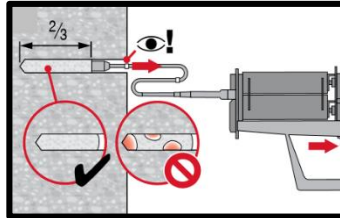
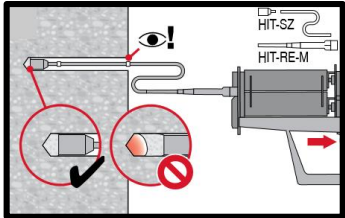

Injection method for drill hole depth
 $h_{ef} > 250 \text{ mm}$.

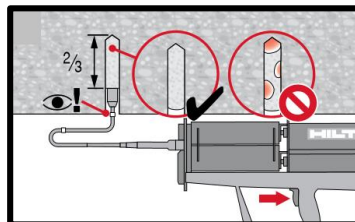
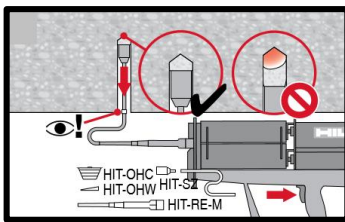

Injection method for overhead
application.

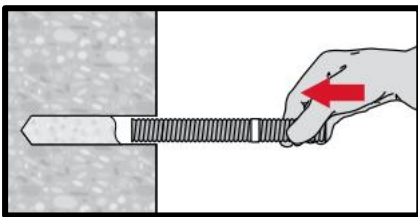

Setting element, observe working time
“ t_{work} ”.

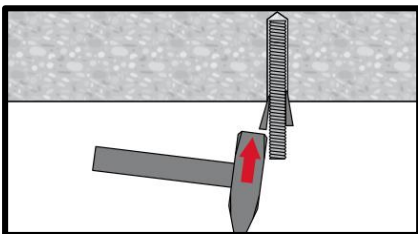

Setting element for overhead
applications, observe working time “ t_{work} ”.

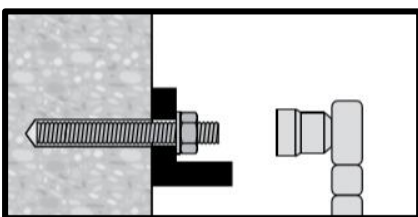

Loading the anchor: After required
curing time t_{cure}

