

TS 300

ALU - Unterkonstruktion für hinterlüftete Fassadenbekleidung
System zur verdeckten Befestigung von ausschließlich
Trespa Fassadenelementen

aluminium support system for rainscreen cladding
system for the concealed attachment of
Trespa cladding panels

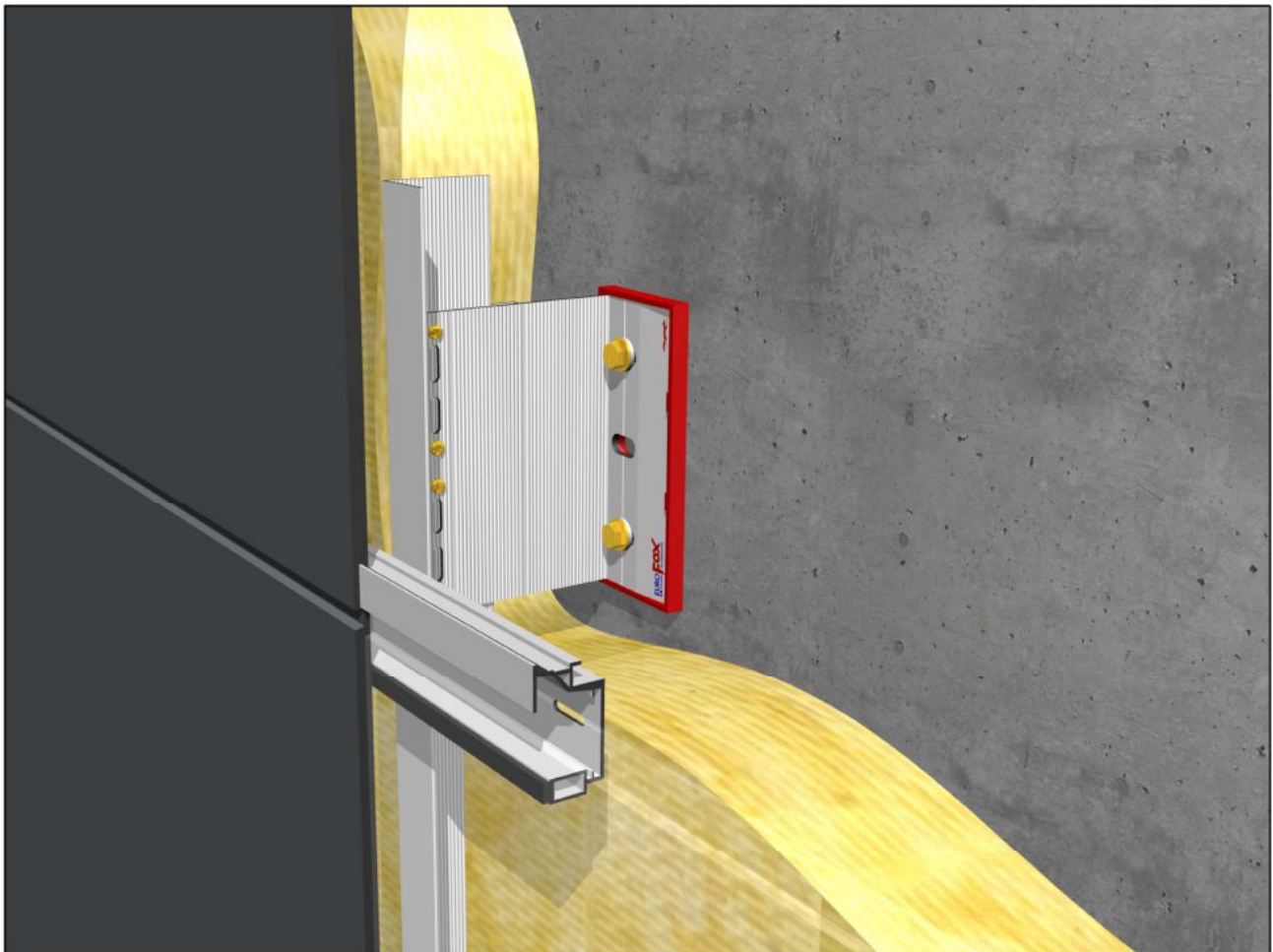

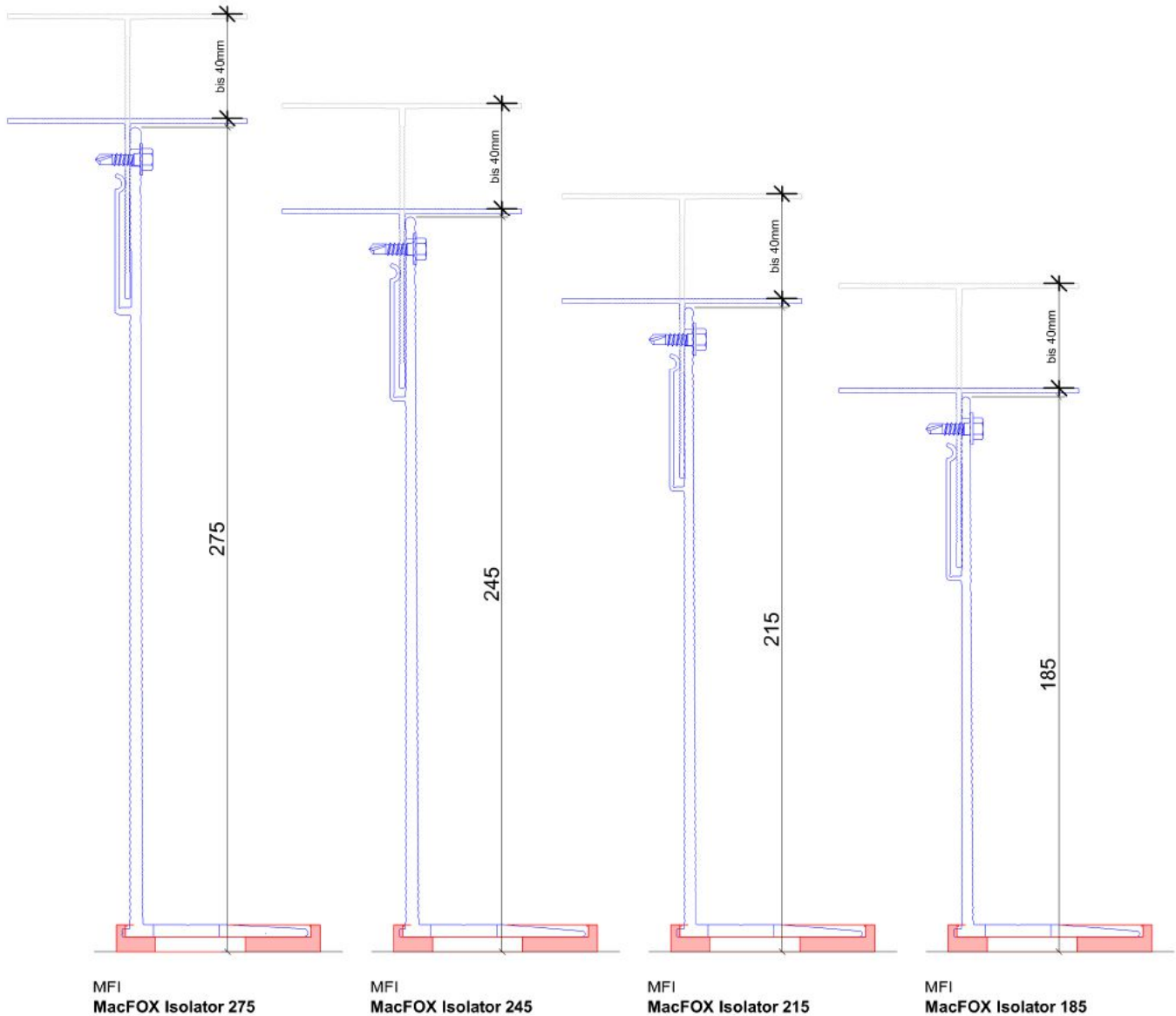

MacFox Isolator M

Länge / length	Loch / aperture ø	Bestellbezeichnung / article code	Artikelnummer / order number
185	6.5mm	MFT - MFI 185M 6.5S	02029353
185	11mm	MFT - MFI 185M 11	02029352
185	15mm	MFT - MFI 185M 15	02029753
215	6.5mm	MFT - MFI 215M 6.5S	02029356
215	11mm	MFT - MFI 215M 11	02029355
215	15mm	MFT - MFI 215M 15	02029756
245	6.5mm	MFT - MFI 245M 6.5S	02029359
245	11mm	MFT - MFI 245M 11	02029358
245	15mm	MFT - MFI 245M 15	02029759
275	6.5mm	MFT - MFI 275M 6.5S	02029763
275	11mm	MFT - MFI 275M 11	02029361
275	15mm	MFT - MFI 275M 15	02029762

MacFox Isolator L

Länge / length	Loch / aperture ø	Bestellbezeichnung / article code	Artikelnummer / order number
185	6.5mm	MFT - MFI 185L 6.5S	02029752
185	11mm	MFT - MFI 185L 11	02029351
185	15mm	MFT - MFI 185L 15	02029751
215	6.5mm	MFT - MFI 215L 6.5S	02029755
215	11mm	MFT - MFI 215L 11	02029354
215	15mm	MFT - MFI 215L 15	02029754
245	6.5mm	MFT - MFI 245L 6.5S	02029758
245	11mm	MFT - MFI 245L 11	02029357
245	15mm	MFT - MFI 245L 15	02029757
275	6.5mm	MFT - MFI 275L 6.5S	02029761
275	11mm	MFT - MFI 275L 11	02029360
275	15mm	MFT - MFI 275L 15	02029760

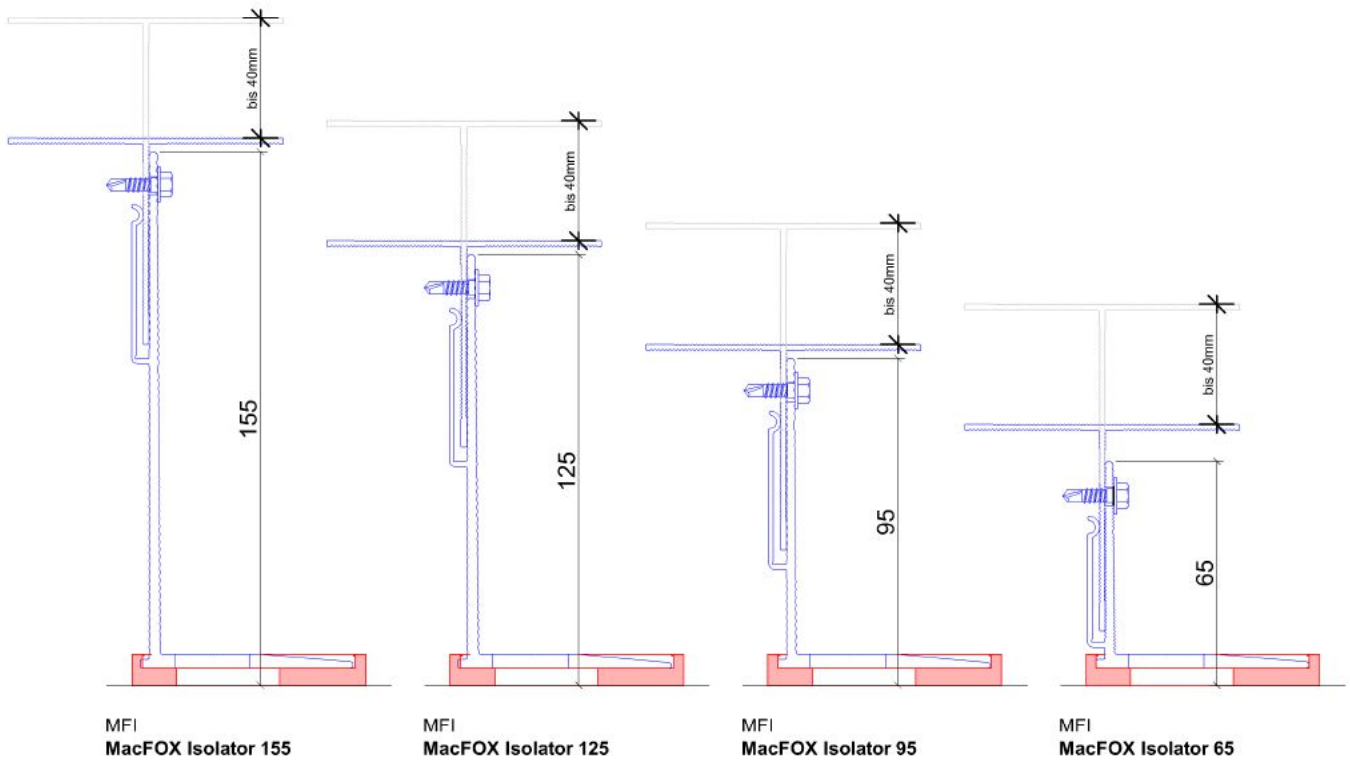

MacFox Isolator M

MacFox Isolator L

Länge / length	Loch / holepattern ø	Bestellbezeichnung / article code	Artikelnummer / order number
65	6.5mm	MFT - MFI 65M 6.5S	02029342
65	11mm	MFT - MFI 65M 11	02029341
65	15mm	MFT - MFI 65M 15	02029740
95	6.5mm	MFT - MFI 95M 6.5S	02029345
95	11mm	MFT - MFI 95M 11	02029344
95	15mm	MFT - MFI 95M 15	02029743
125	6.5mm	MFT - MFI 125M 6.5S	02029348
125	11mm	MFT - MFI 125M 11	02029347
125	15mm	MFT - MFI 125M 15	02029746
155	6.5mm	MFT - MFI 155M 6.5S	02029750
155	11mm	MFT - MFI 155M 11	02029350
155	15mm	MFT - MFI 155M 15	02029749

Länge / length	Loch / holepattern ø	Bestellbezeichnung / article code	Artikelnummer / order number
65	6.5mm	MFT - MFI 65L 6.5S	02029340
65	11mm	MFT - MFI 65L 11	02029349
65	15mm	MFT - MFI 65L 15	02029739
95	6.5mm	MFT - MFI 95L 6.5S	02029742
95	11mm	MFT - MFI 95L 11	02029343
95	15mm	MFT - MFI 95L 15	02029741
125	6.5mm	MFT - MFI 125L 6.5S	02029745
125	11mm	MFT - MFI 125L 11	02029346
125	15mm	MFT - MFI 125L 15	02029744
155	6.5mm	MFT - MFI 155L 6.5S	02029748
155	11mm	MFT - MFI 155L 11	02029349
155	15mm	MFT - MFI 155L 15	02029747

MFT - MFI L

A1L

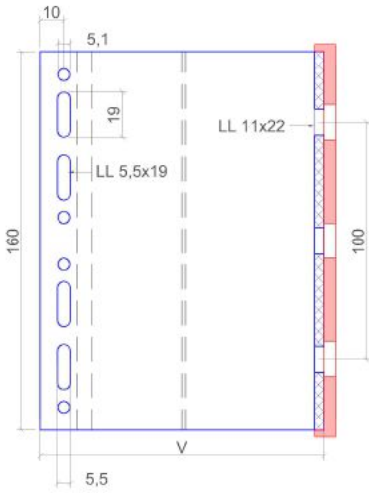

Large L h=160

A2L

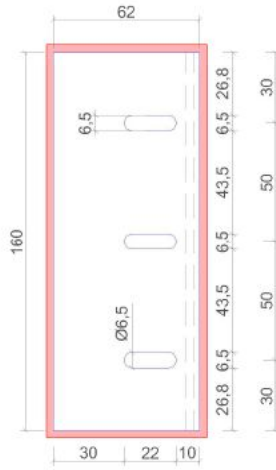

Lochdurchmesser 6,5mm
holepattern 6,5mm

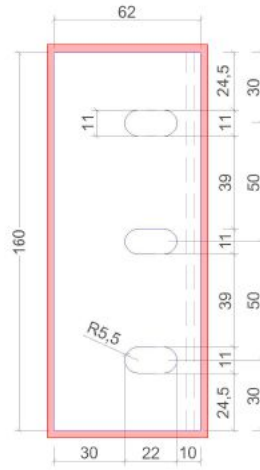

Lochdurchmesser 11mm
holepattern 11mm

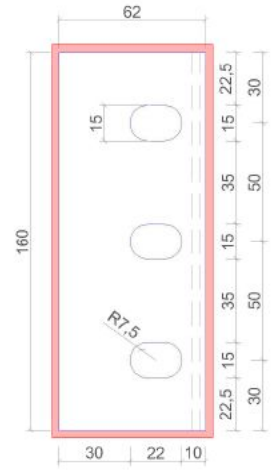

Lochdurchmesser 15mm
holepattern 15mm

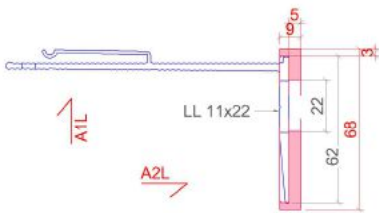

MFT - MFI M

A1M

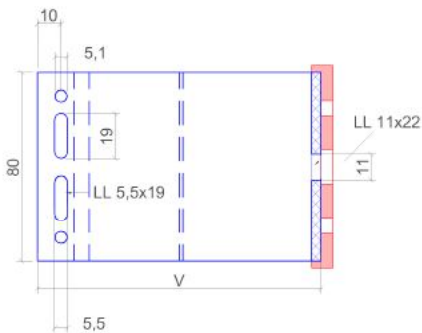

Medium M h=80

A2M

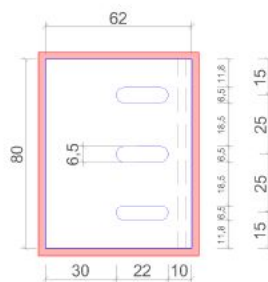

Lochdurchmesser 6,5mm
holepattern 6,5mm

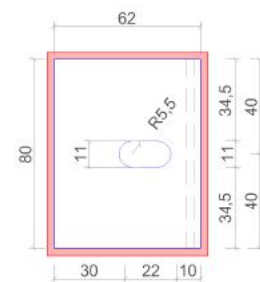

Lochdurchmesser 11mm
holepattern 11mm

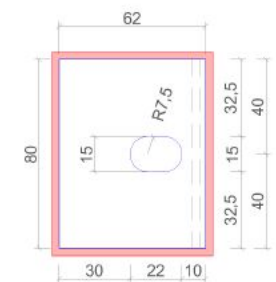

Lochdurchmesser 15mm
holepattern 15mm

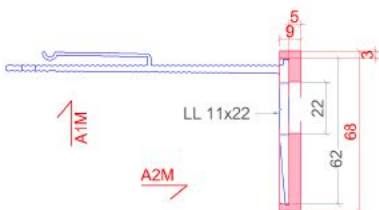

TS 300

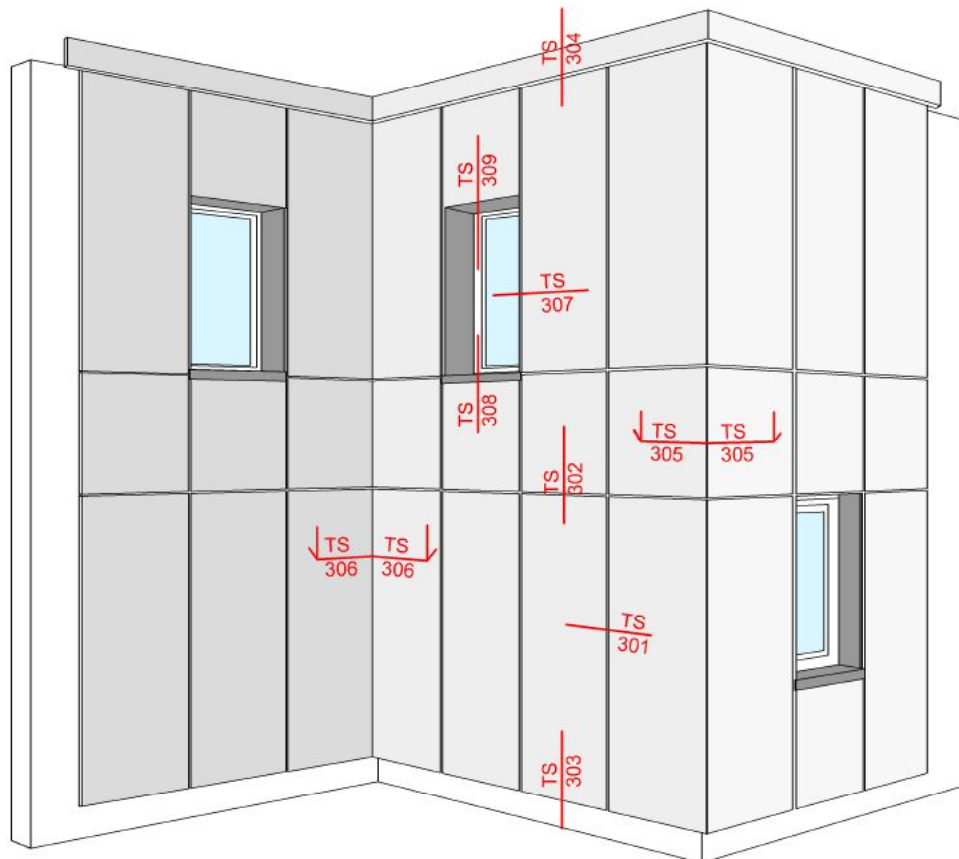

Fassadenansicht / view of cladding

INHALT:

TS -301	Horizontalschnitt
TS -302	Vertikalschnitt
TS -303	Sockelabschluss
TS -304	Dachanschluss Attika
TS -305	Aussenecke
TS -306	Innenecke
TS -307	Fensterleibung
TS -308	Fensterbank
TS -309	Fenstersturz

CONTENTS:

TS -301	horizontal section
TS -302	vertical section
TS -303	base detail
TS -304	head detail
TS -305	external corner
TS -306	internal corner
TS -307	window - reveal
TS -308	window - sill
TS -309	window - lintel

TS - 300 Befestigung/ TS - 300 fixing

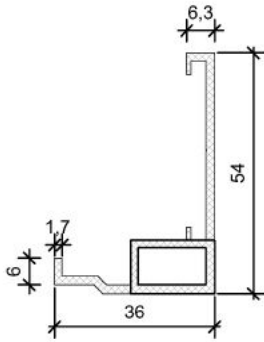

Anfangsprofil
start profile

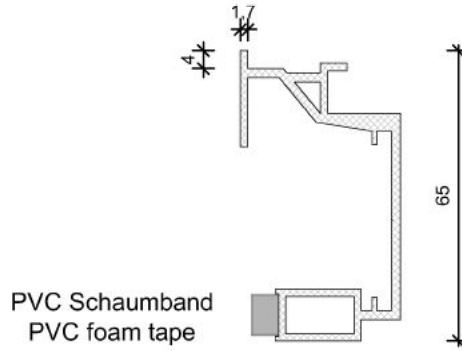

Hauptprofil
support profile

Beschreibung discription	Artikelnummer order number
MFT-TS 300 HP	02030625
MFT-TS 300 AP	02030624
MFT-TS 300 TAP	02030623

Bekleidungsdicke cladding thickness	Plattenhöhe panel height	Plattenlänge panel length
8 mm	650 mm	3000 mm
10 mm	750 mm	3000 mm
13 mm	950 mm	3000 mm

Plattenstoßprofilierung - panel forms

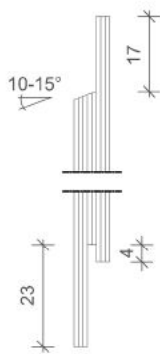

2 3
8 mm

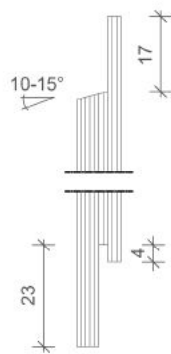

2 3
10, 13 oder
10 - 16* mm

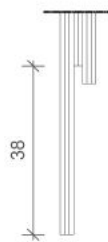

2 3
8 mm

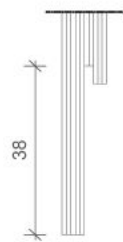

2 3
10, 13 oder
10 - 16* mm

Varianten Vertikalfuge - variants vertical joint

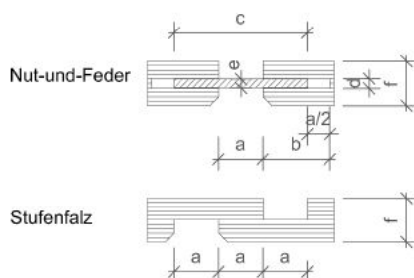

- a. Mind. 10 mm
- b. Mind. 15 mm
- c. Mind. 30 mm
- d. Mind. 2,2 mm Al / 3,2 mm Trespa
- e. Mind. 2,0 mm Al / 3,0 mm Trespa
- f. 8 oder 10 mm

TS- 301

Horizontalschnitt - MacFOX / horizontal section - MacFOX

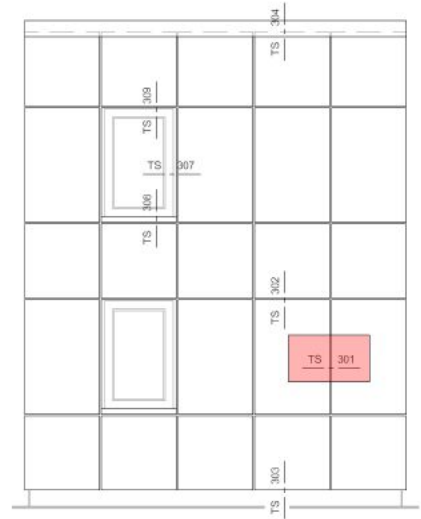
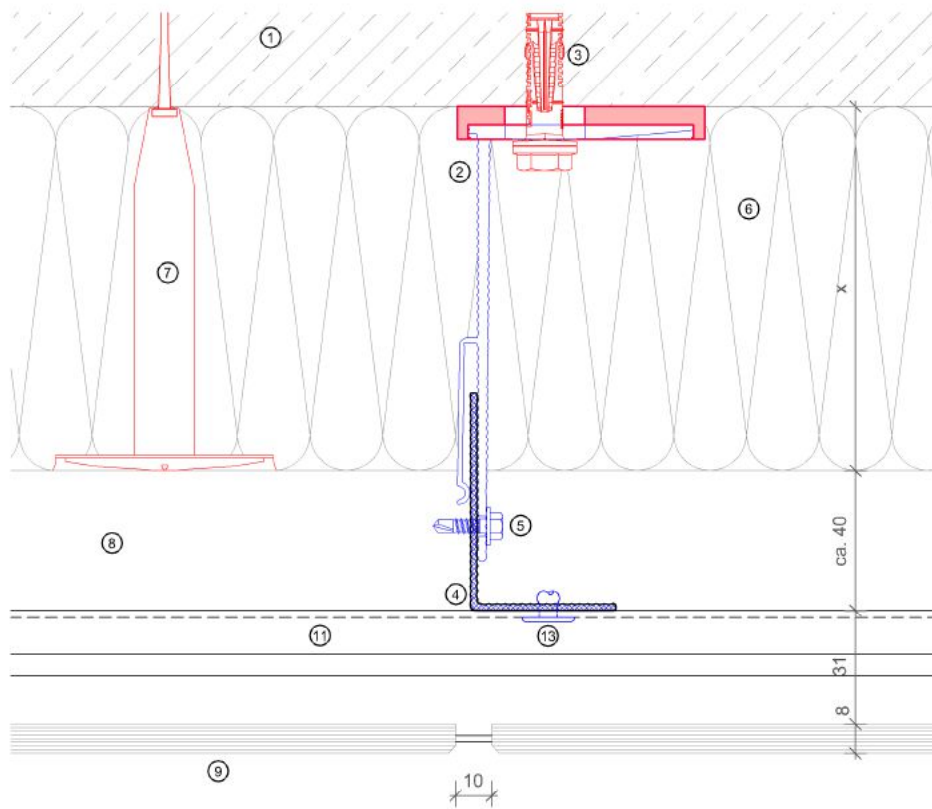

Legende	
1	Untergrund/ basement
2	Distanzhalter + Isolator/ bracket + isolator
3	Dübel lt. Statik/ anchor acc. to static
4	Tragprofil/ profile
5	Bohrschraube/ self drilling screw
6	Wärmedämmung/ insulation
7	Befestigung WD/ fixing insulation
8	Hinterlüftung/ ventilation
9	Fassadenplatte/ cladding
10	Anfangsprofil/ start profile
11	Hauptprofil/ support profile
12	Schaumband/ foam volume
13	Befestigung Profil/ fixing profile

TS - 302

Vertikalschnitt-Gleitpunkt / vertical section-flexible point

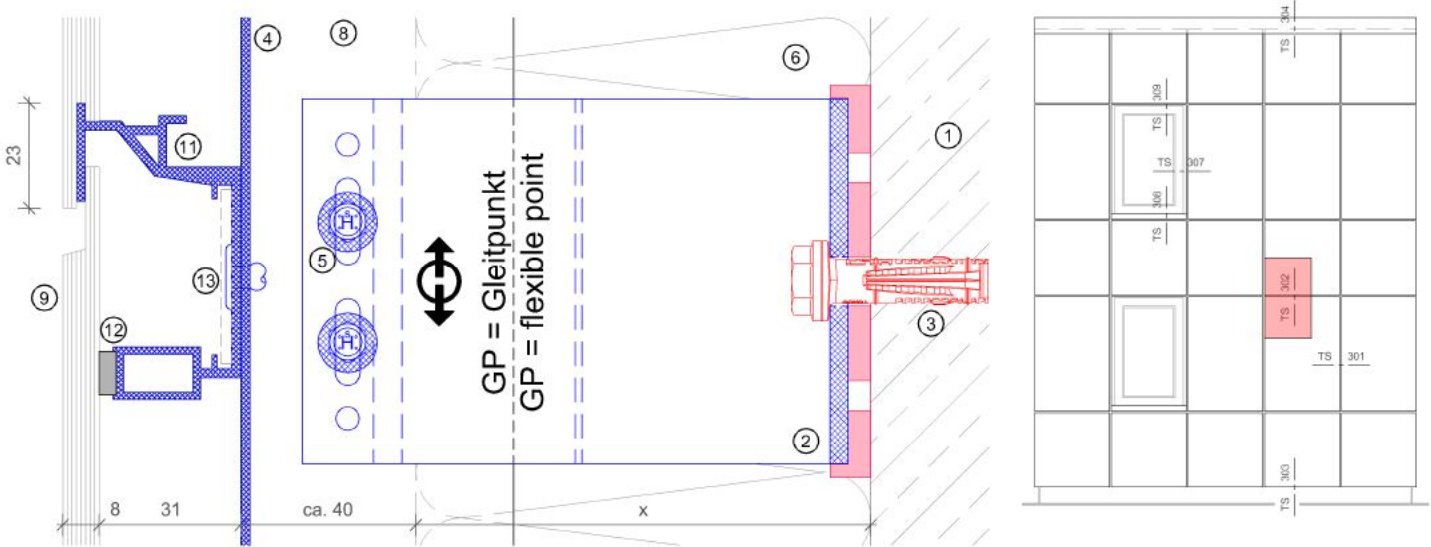

Vertikalschnitt-Fixpunkt / vertical section-fixed point

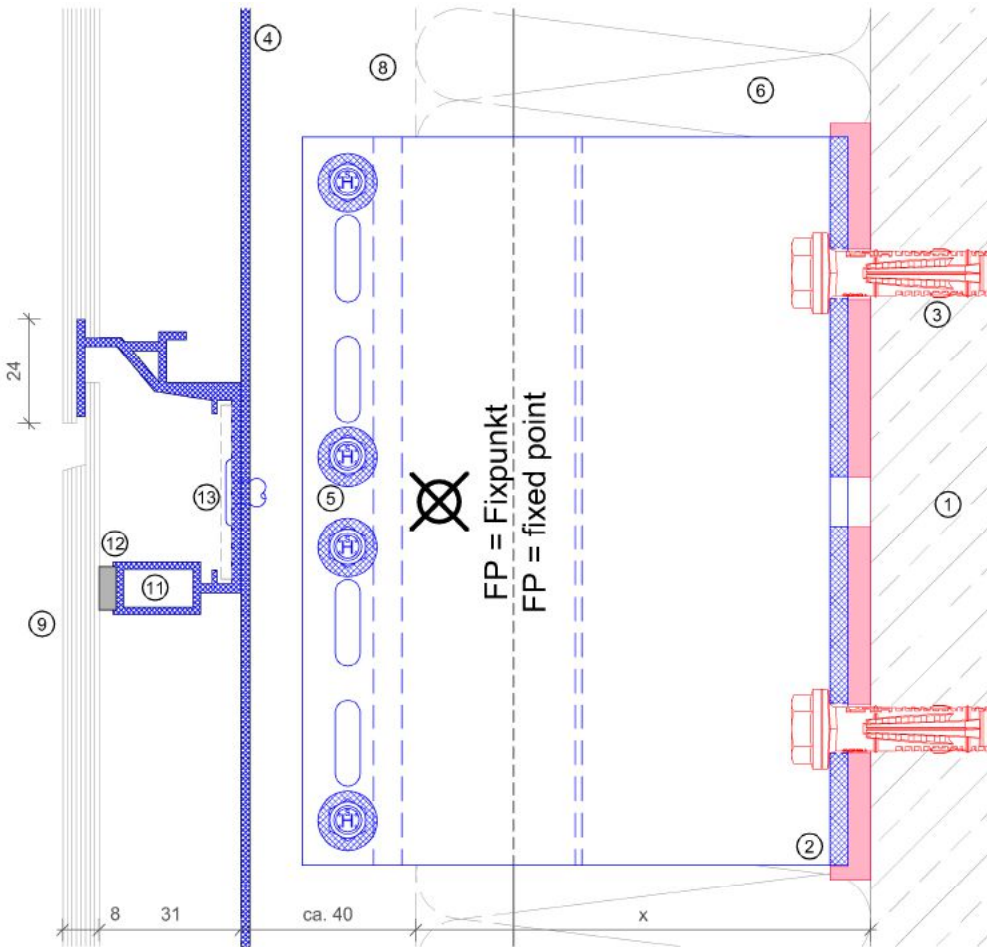

Legende	
1	Untergrund/ basement
2	Distanzhalter + Isolator/ bracket + isolator
3	Dübel lt. Statik/ anchor acc. to static
4	Tragprofil/ profile
5	Bohrschraube/ self drilling screw
6	Wärmedämmung/ insulation
7	Befestigung WD/ fixing insulation
8	Hinterlüftung/ ventilation
9	Fassadenplatte/ cladding
10	Anfangsprofil/ start profile
11	Hauptprofil/ support profile
12	Schaumband/ foam volume
13	Befestigung Profil/ fixing profile

TS - 302.1

Vertikalschnitt - MacFOX - Profilstoss / vertical section - MacFOX - joint of profile

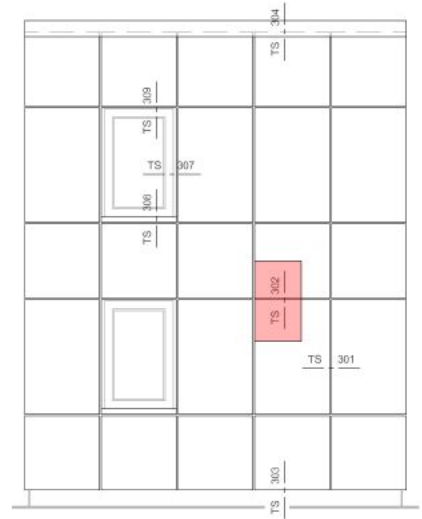
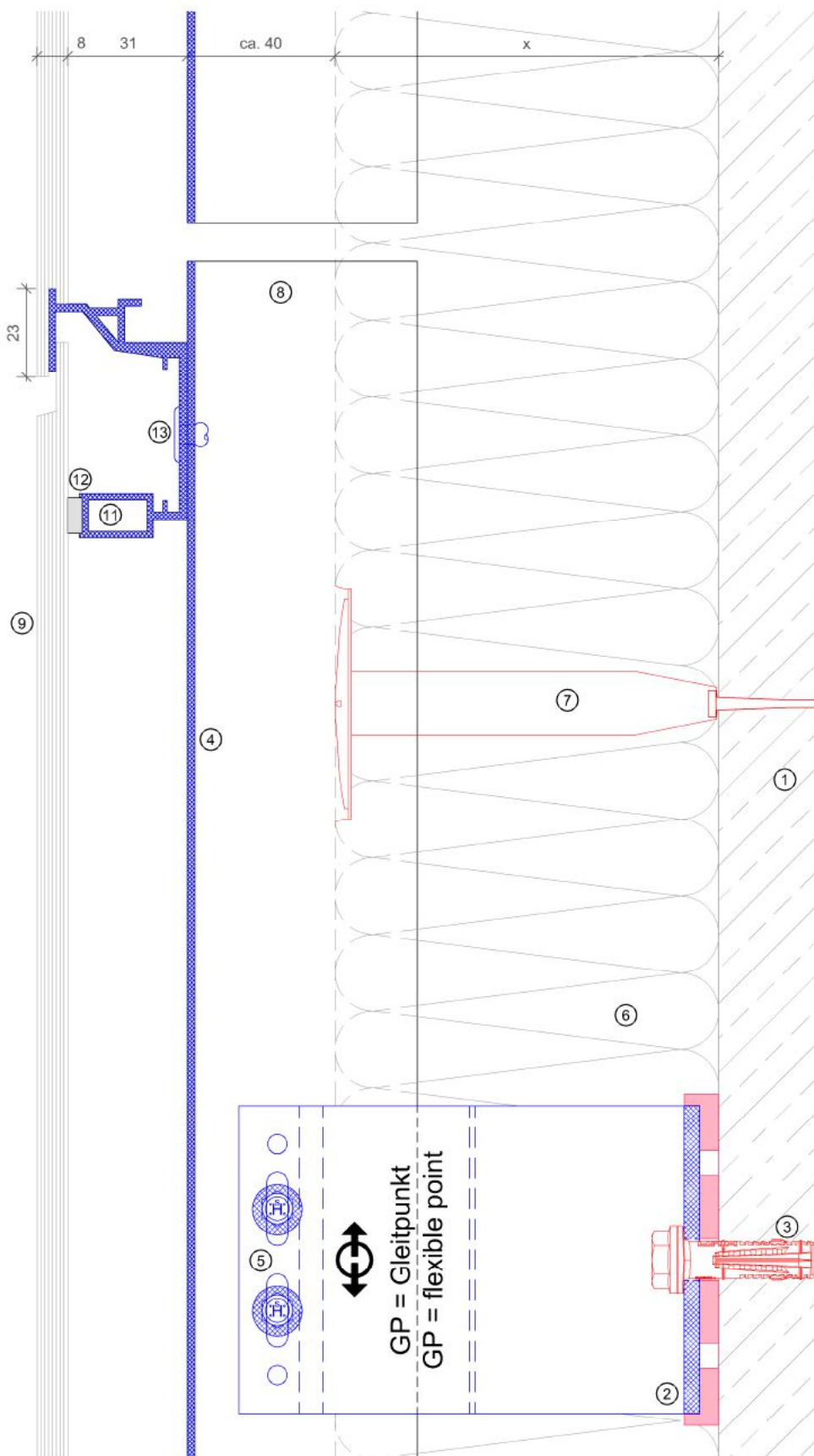

Legende	
1	Untergrund/ basement
2	Distanzhalter + Isolator/ bracket + isolator
3	Dübel lt. Statik/ anchor acc. to static
4	Tragprofil/ profile
5	Bohrschraube/ self drilling screw
6	Wärmedämmung/ insulation
7	Befestigung WD/ fixing insulation
8	Hinterlüftung/ ventilation
9	Fassadenplatte/ cladding
10	Anfangsprofil/ start profile
11	Hauptprofil/ support profile
12	Schaumband/ foam volume
13	Befestigung Profil/ fixing profile

TS - 303

Vertikalschnitt - Sockelabschluss / vertical section - bottom detail

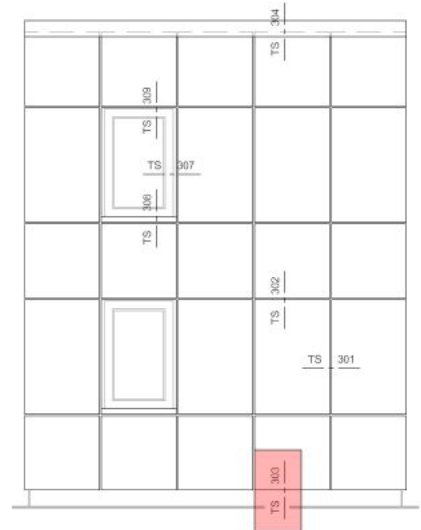
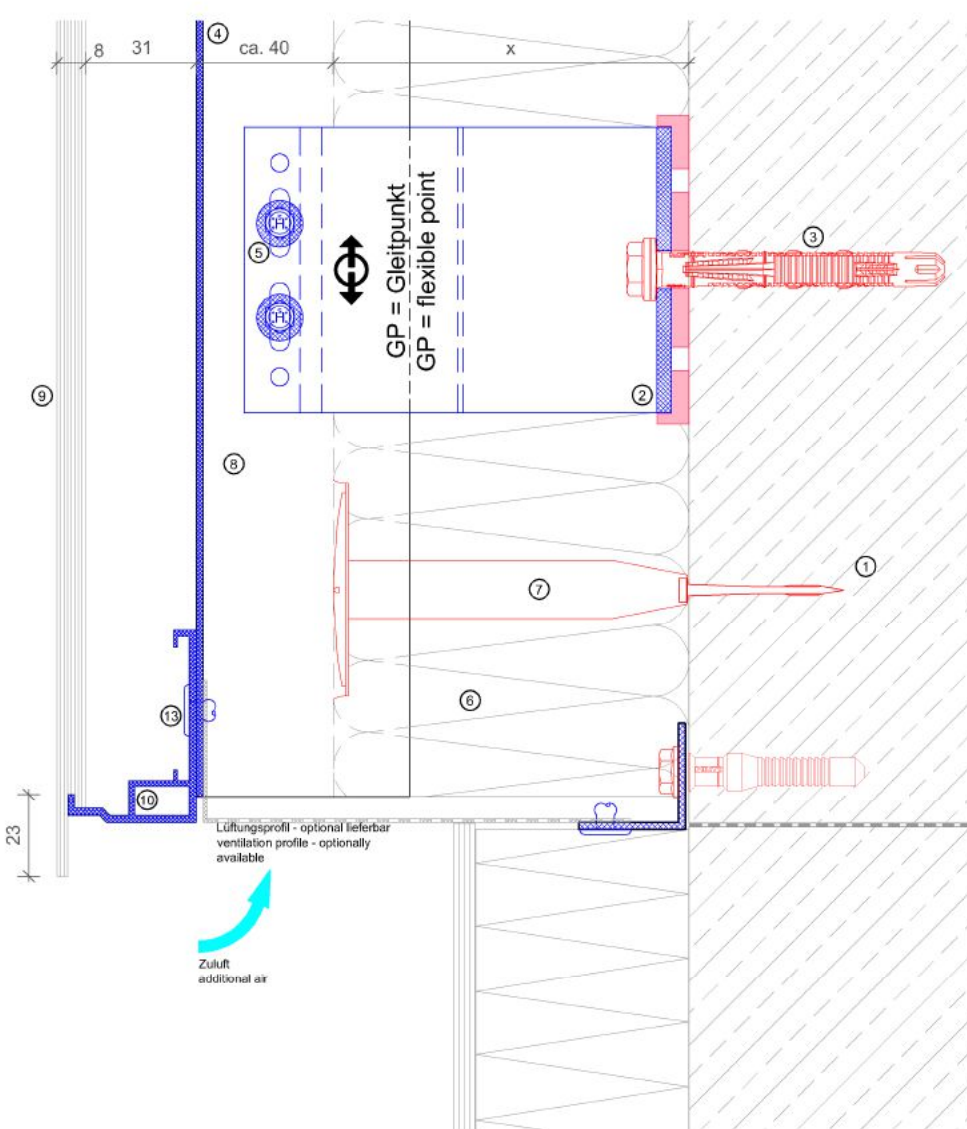

Legende	
1	Untergrund/ basement
2	Distanzhalter + Isolator/ bracket + isolator
3	Dübel lt. Statik/ anchor acc. to static
4	Tragprofil/ profile
5	Bohrschraube/ self drilling screw
6	Wärmedämmung/ insulation
7	Befestigung WD/ fixing insulation
8	Hinterlüftung/ ventilation
9	Fassadenplatte/ cladding
10	Anfangsprofil/ start profile
11	Hauptprofil/ support profile
12	Schaumband/ foam volume
13	Befestigung Profil/ fixing profile

TS - 304

Vertikalschnitt - Dachanschluss - Attika / vertical section - head detail

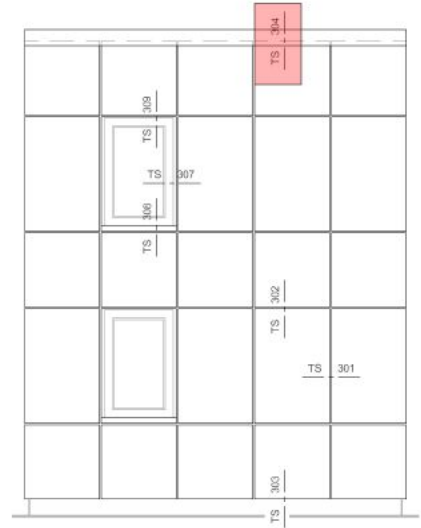
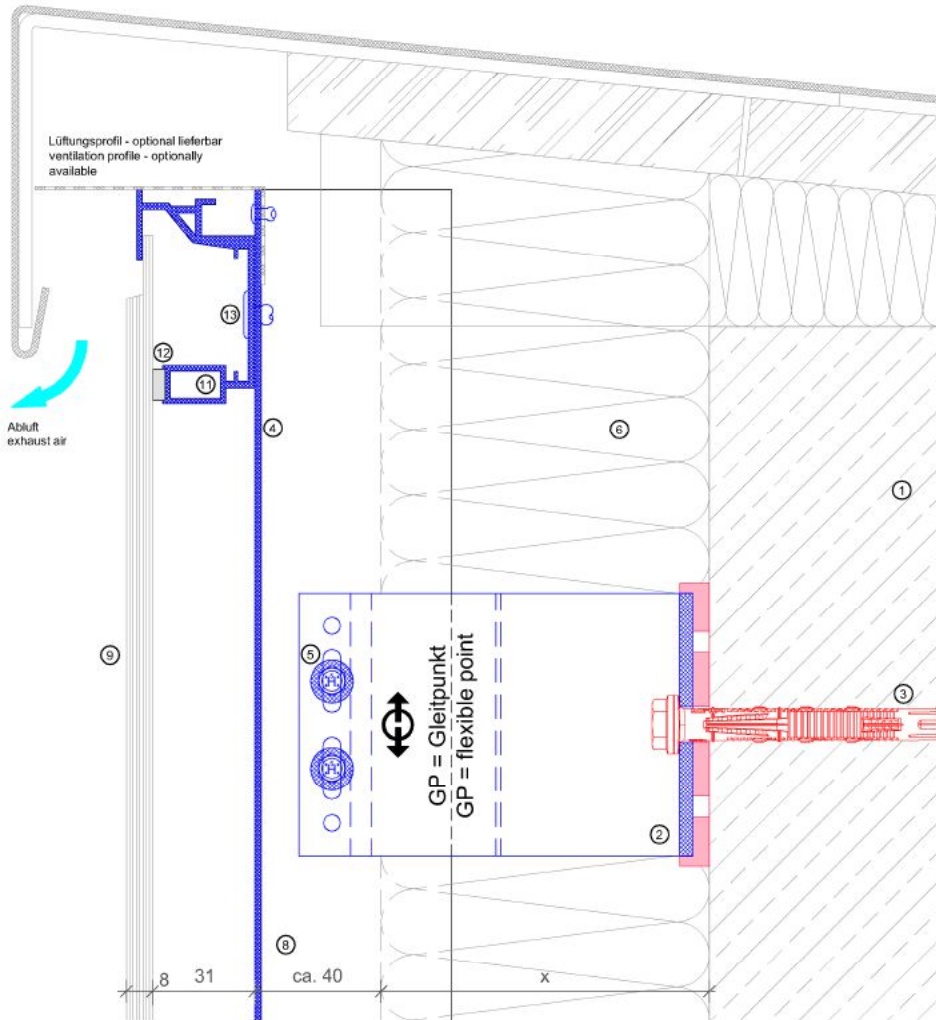

Legende	
1	Untergrund/ basement
2	Distanzhalter + Isolator/ bracket + isolator
3	Dübel lt. Statik/ anchor acc. to static
4	Tragprofil/ profile
5	Bohrschraube/ self drilling screw
6	Wärmedämmung/ insulation
7	Befestigung WD/ fixing insulation
8	Hinterlüftung/ ventilation
9	Fassadenplatte/ cladding
10	Anfangsprofil/ start profile
11	Hauptprofil/ support profile
12	Schaumband/ foam volume
13	Befestigung Profil/ fixing profile

TS - 305

Horizontalschnitt - Aussenecke / horizontal section - external corner

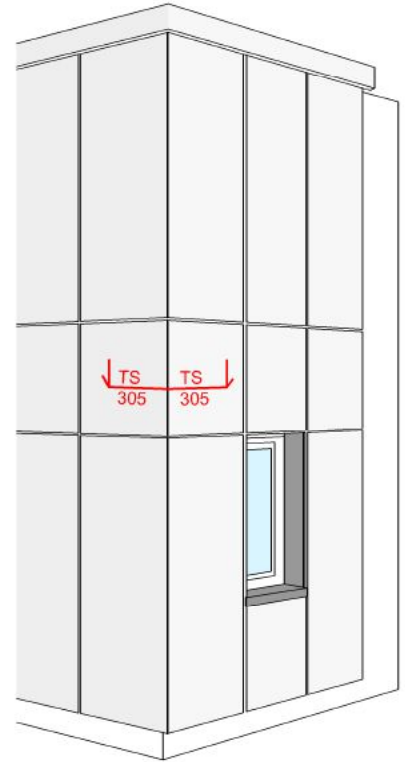
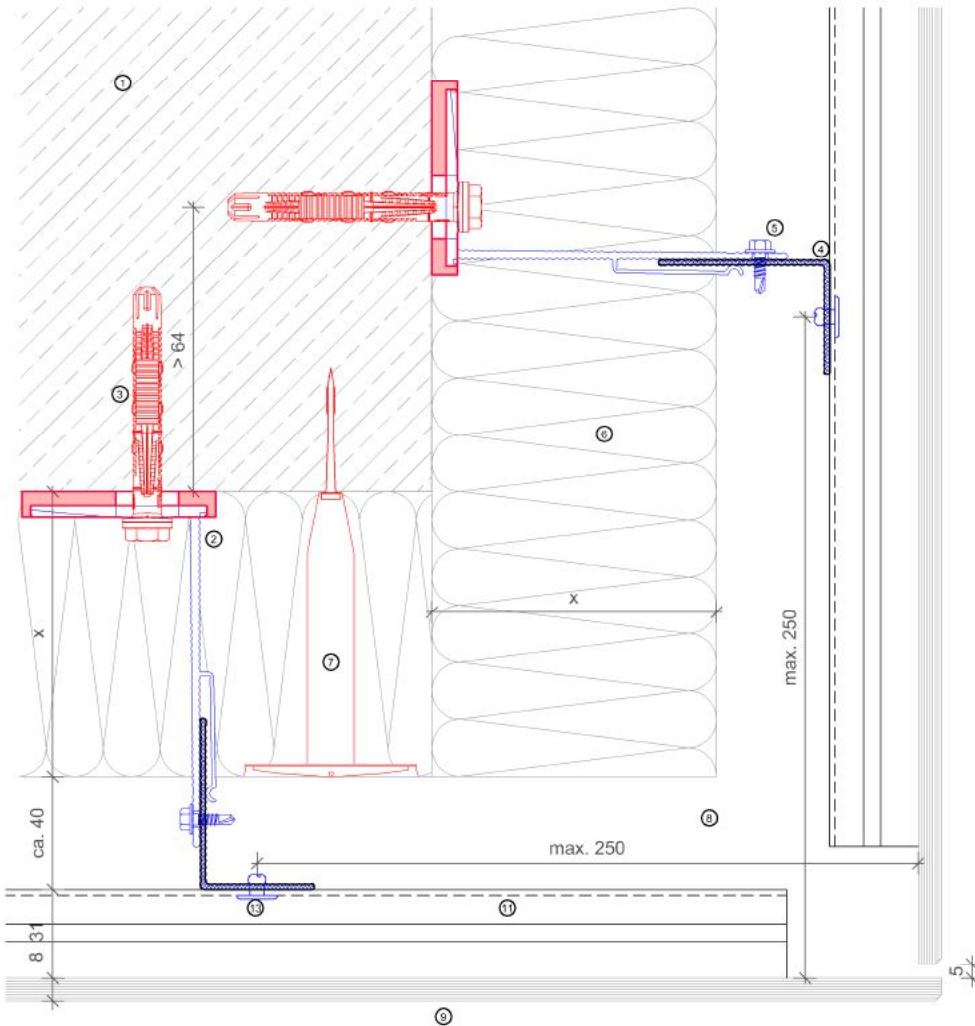

Legende	
1	Untergrund/ basement
2	Distanzhalter + Isolator/ bracket + isolator
3	Dübel lt. Statik/ anchor acc. to static
4	Tragprofil/ profile
5	Bohrschraube/ self drilling screw
6	Wärmedämmung/ insulation
7	Befestigung WD/ fixing insulation
8	Hinterlüftung/ ventilation
9	Fassadenplatte/ cladding
10	Anfangsprofil/ start profile
11	Hauptprofil/ support profile
12	Schaumband/ foam volume
13	Befestigung Profil/ fixing profile

TS - 306

Horizontalschnitt - Innenecke / horizontal section - internal corner

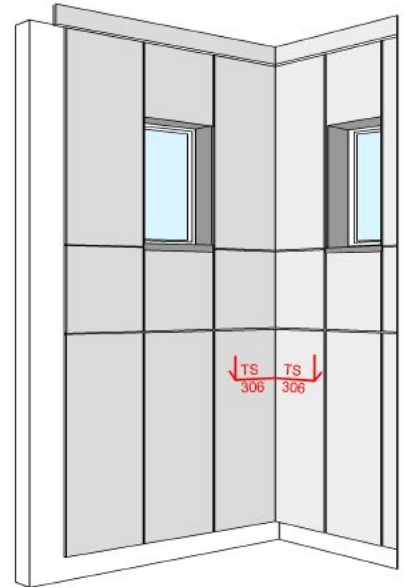
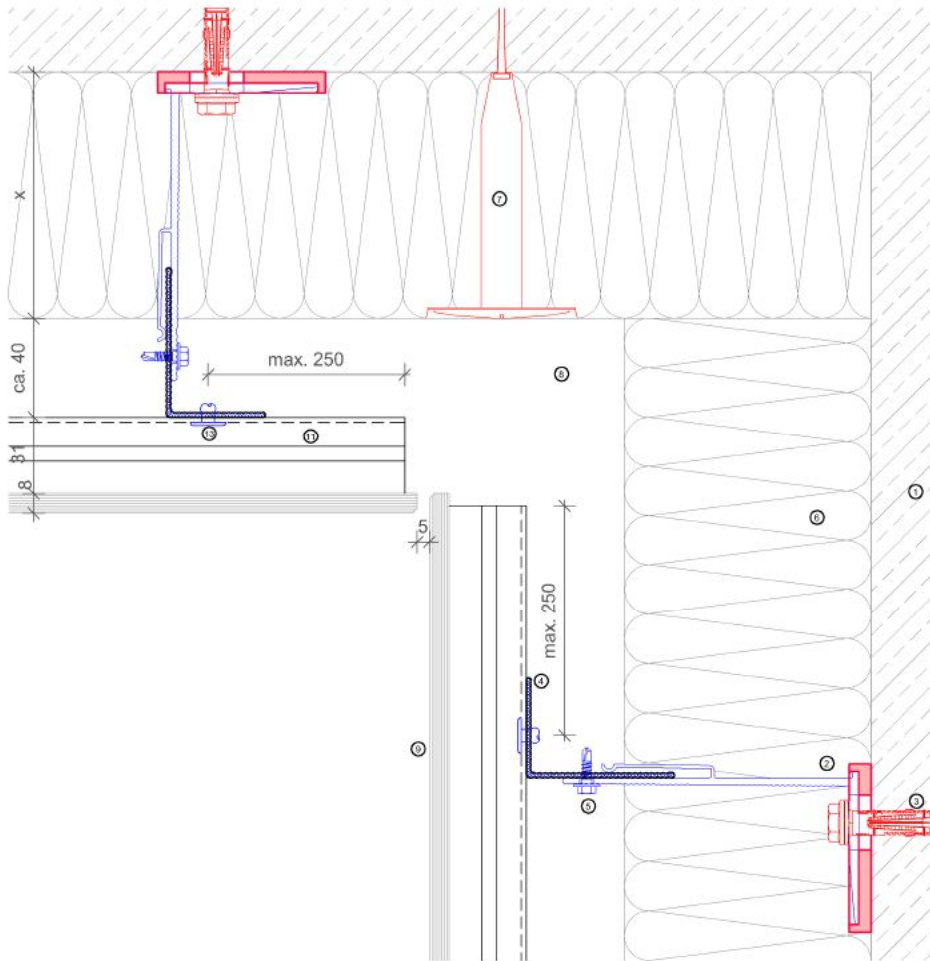

Legende	
1	Untergrund/ basement
2	Distanzhalter + Isolator/ bracket + isolator
3	Dübel lt. Statik/ anchor acc. to static
4	Tragprofil/ profile
5	Bohrschraube/ self drilling screw
6	Wärmedämmung/ insulation
7	Befestigung WD/ fixing insulation
8	Hinterlüftung/ ventilation
9	Fassadenplatte/ cladding
10	Anfangsprofil/ start profile
11	Hauptprofil/ support profile
12	Schaumband/ foam volume
13	Befestigung Profil/ fixing profile

TS - 307

Horizontalschnitt - Fensterleibung / horizontal section - window - reveal

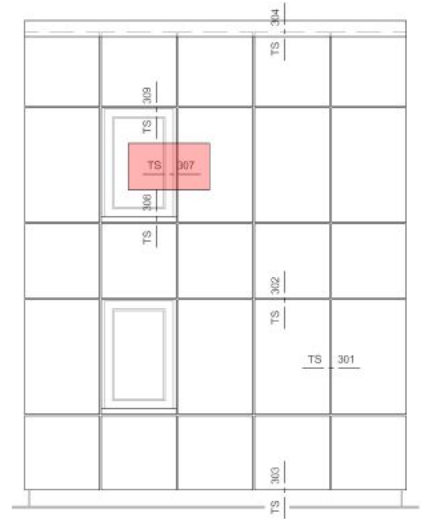
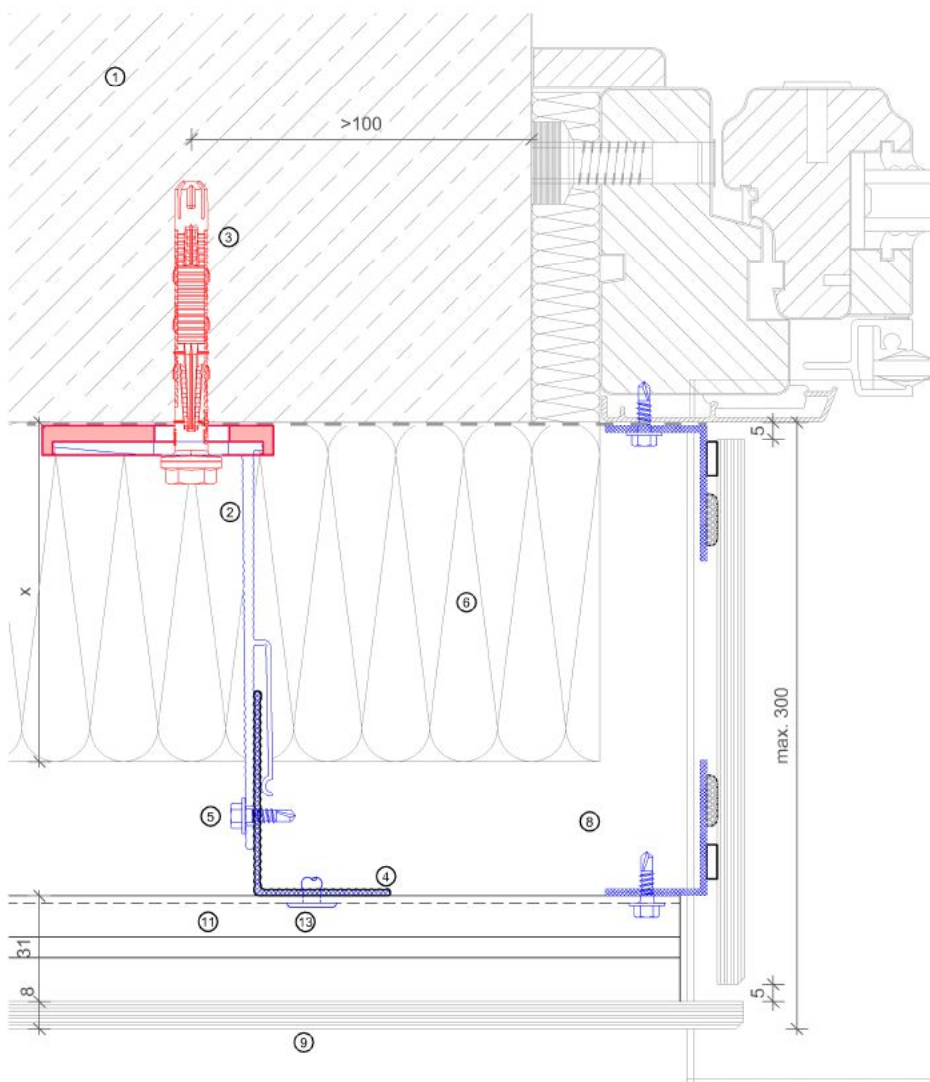

Legende	
1	Untergrund/ basement
2	Distanzhalter + Isolator/ bracket + isolator
3	Dübel lt. Statik/ anchor acc. to static
4	Tragprofil/ profile
5	Bohrschraube/ self drilling screw
6	Wärmedämmung/ insulation
7	Befestigung WD/ fixing insulation
8	Hinterlüftung/ ventilation
9	Fassadenplatte/ cladding
10	Anfangsprofil/ start profile
11	Hauptprofil/ support profile
12	Schaumband/ foam volume
13	Befestigung Profil/ fixing profile

TS - 308

Vertikalschnitt - Fensterbank / vertical section - window - sill

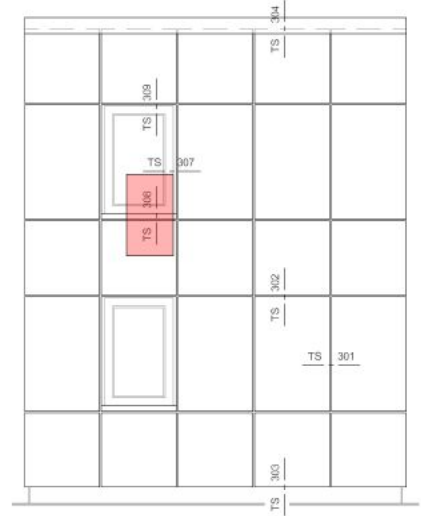
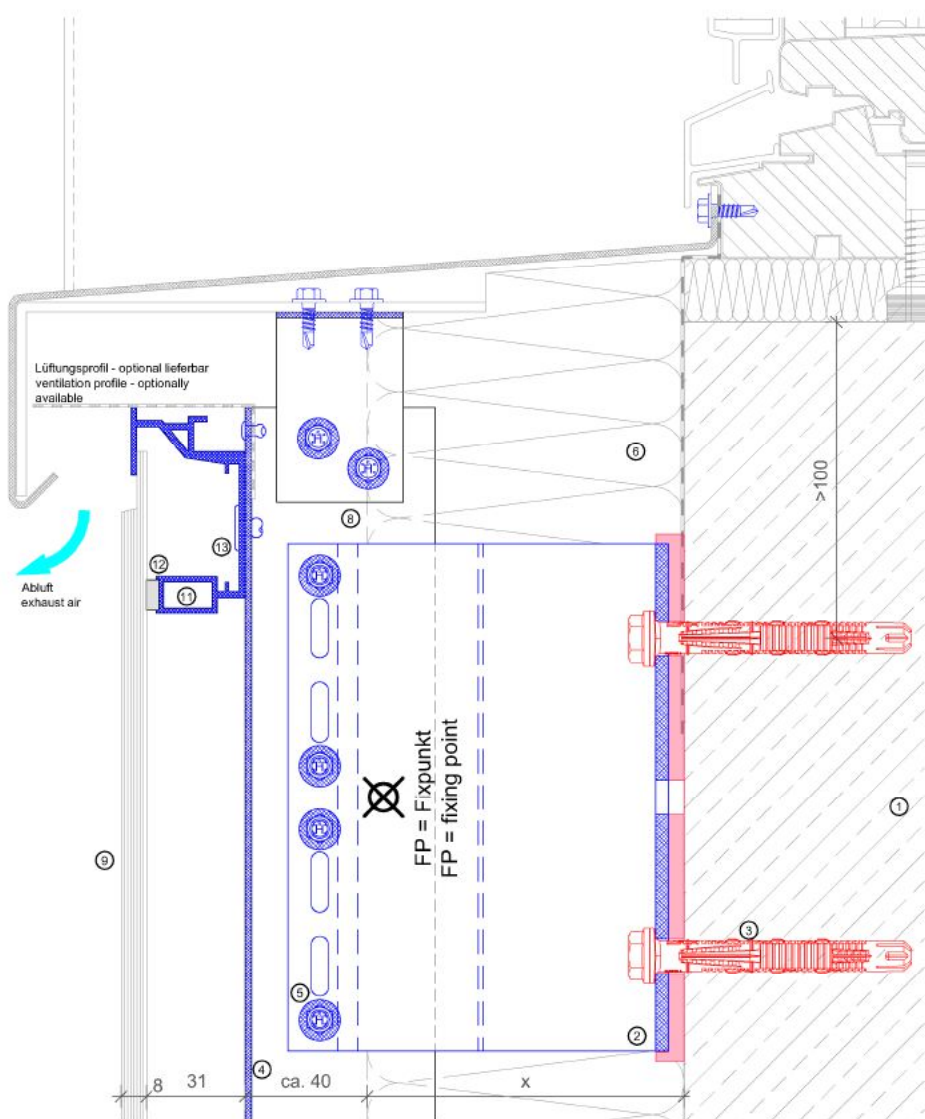

Legende	
1	Untergrund/ basement
2	Distanzhalter + Isolator/ bracket + isolator
3	Dübel lt. Statik/ anchor acc. to static
4	Tragprofil/ profile
5	Bohrschraube/ self drilling screw
6	Wärmedämmung/ insulation
7	Befestigung WD/ fixing insulation
8	Hinterlüftung/ ventilation
9	Fassadenplatte/ cladding
10	Anfangsprofil/ start profile
11	Hauptprofil/ support profile
12	Schaumband/ foam volume
13	Befestigung Profil/ fixing profile

TS - 309

Vertikalschnitt - Fenstersturz / vertical section - window - lintel

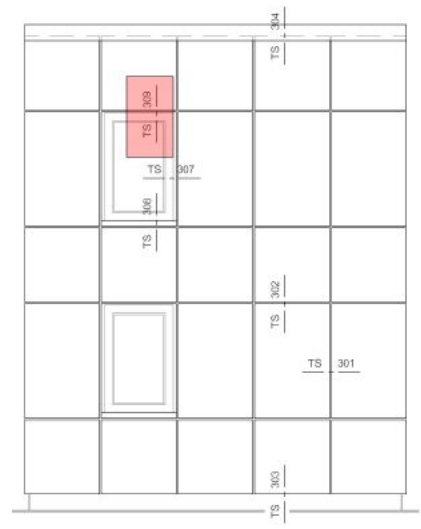
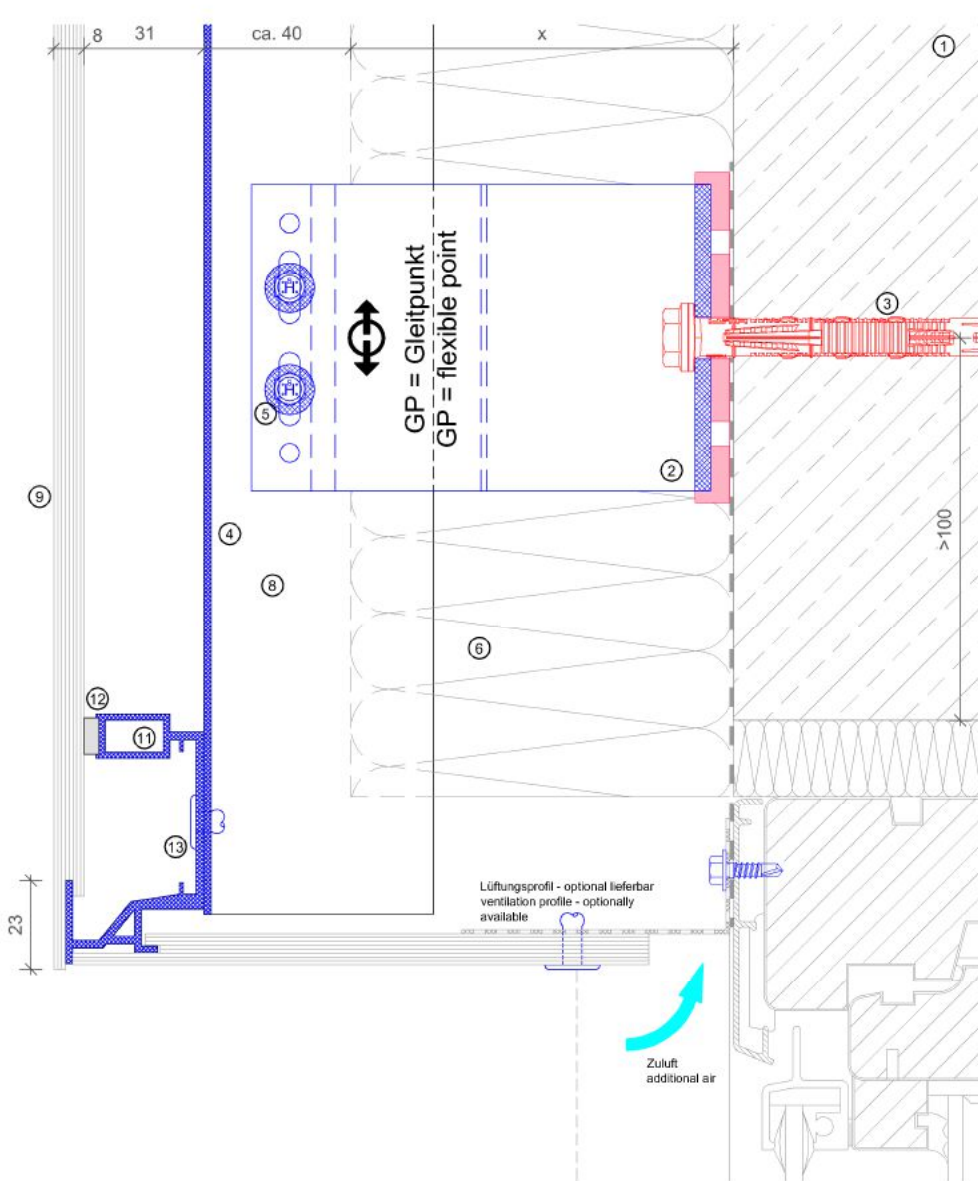

Legende	
1	Untergrund/ basement
2	Distanzhalter + Isolator/ bracket + isolator
3	Dübel lt. Statik/ anchor acc. to static
4	Tragprofil/ profile
5	Bohrschraube/ self drilling screw
6	Wärmedämmung/ insulation
7	Befestigung WD/ fixing insulation
8	Hinterlüftung/ ventilation
9	Fassadenplatte/ cladding
10	Anfangsprofil/ start profile
11	Hauptprofil/ support profile
12	Schaumband/ foam volume
13	Befestigung Profil/ fixing profile

TS - 309.1

Vertikalschnitt - Fenstersturz / vertical section - window - lintel

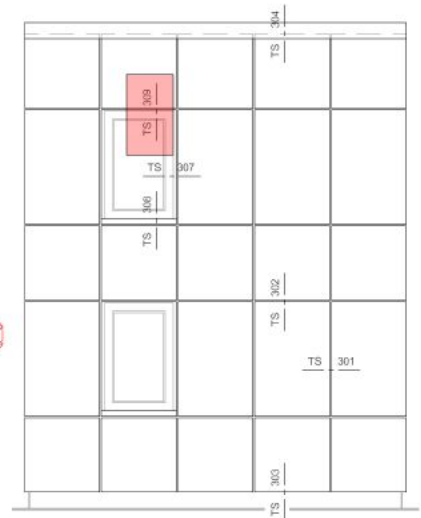
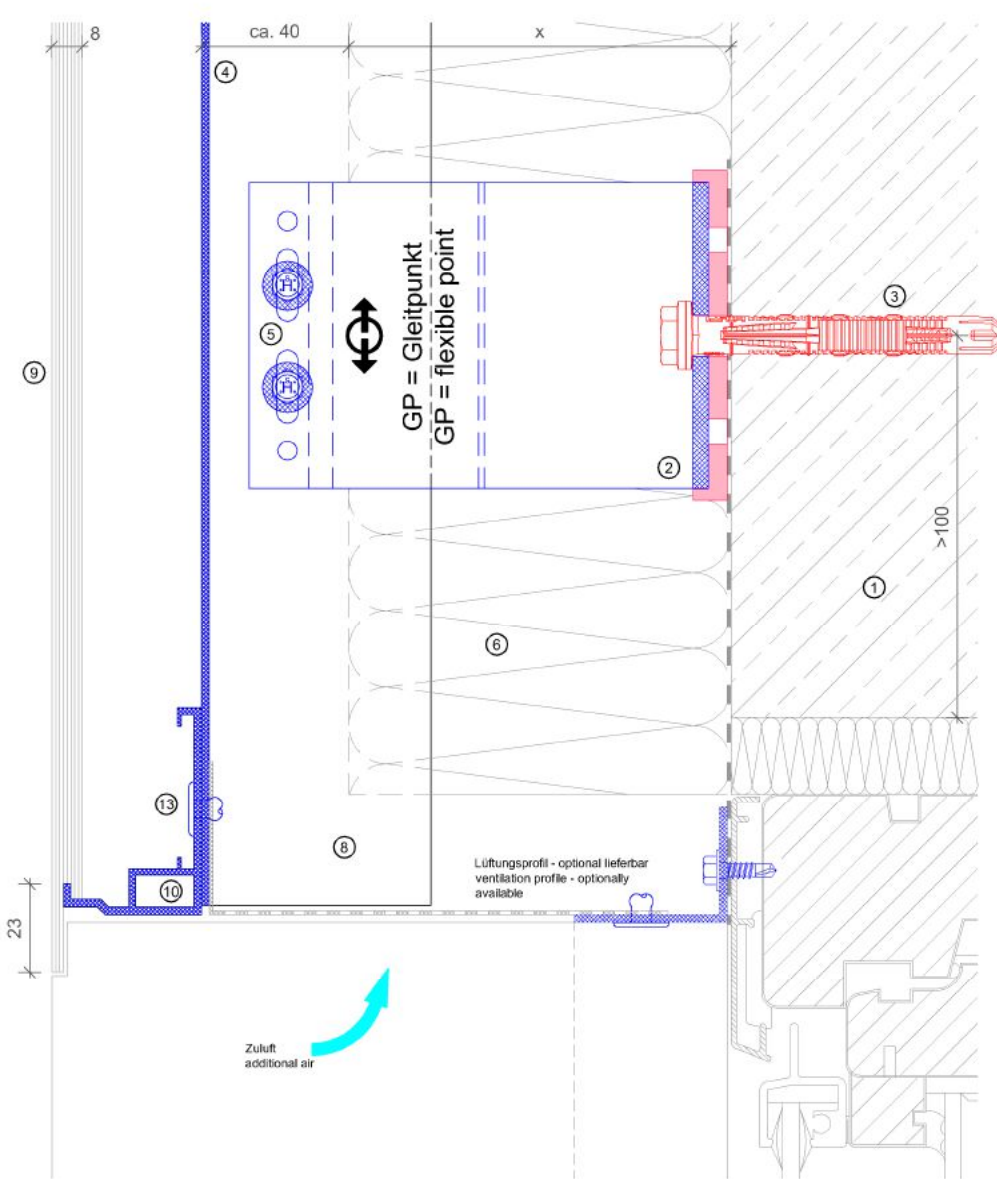

Legende	
1	Untergrund/ basement
2	Distanzhalter + Isolator/ bracket + isolator
3	Dübel lt. Statik/ anchor acc. to static
4	Tragprofil/ profile
5	Bohrschraube/ self drilling screw
6	Wärmedämmung/ insulation
7	Befestigung WD/ fixing insulation
8	Hinterlüftung/ ventilation
9	Fassadenplatte/ cladding
10	Anfangsprofil/ start profile
11	Hauptprofil/ support profile
12	Schaumband/ foam volume
13	Befestigung Profil/ fixing profile