

HILTI

Fastening
Technology Manual

Dynamic Design
for Anchors



Contents

1. Dynamic loads and applications	3
2. Fatigue	7
2.1 Definition of fatigue load	7
2.2 Materials under fatigue load	8
2.3 Anchor behaviour	10
2.4 Anchor design for fatigue	11
2.4.1 Design load	11
2.4.2 Prestressing force in the anchor	12
2.4.3 Fatigue relevant part of the force in the anchor	12
2.4.4 Static resistance	13
2.4.5 Fatigue resistance	13
2.4.6 Simplified estimation of fatigue resistance	14
2.5 Product information: fatigue	14
2.5.1 Product information HDA	15
2.5.2 Product information HVZ	18
2.5.3 Other Anchors	20
2.6 Design examples: fatigue	20
2.6.1 Simplified design for the fixing of crane track with dynamic loads in a concrete member	20
2.6.2 Simplified design for the fixing of unbalanced rotating machine in a concrete member	23
3. Earthquakes (seismic loading)	26
3.1 Characteristics of seismic actions	26
3.2 Anchor behaviour under seismic actions	27
3.3 Anchor design for seismic actions	28
3.4 Product information: Seismic	31
3.5 Design example water tank on roof	31
3.5.1 Design situation	31
3.5.2 Influence of stiffeners	33
4. Shock	35
4.1 Shock loads	35
4.2 Anchors under shock load	35
4.3 Anchor design for shock loads	36
4.4 Product information: Shock	36
4.5 Design examples: Shock	39
4.5.1 Elastic collision: Fixing of safety rope	39
4.5.2 Simplified design acc. to regulations of BZS	40
References/literature	42
Appendix A: Dynamic Set	43
Setting instructions	44

1. Dynamic loads and applications

Introduction

Common engineering design focuses around static loads. With this in mind, it is important to realise that static loads are indeed a very special case that - theoretically - almost never occur in practice. Clearly, the applicable safety factors for static design account for most effects of minor dynamic loading situations that are commonly addressed by using a static simplification. This brochure is intended to highlight those cases, however, where such static simplification may significantly misrepresent the true loading situation and potentially lead to under-design of anchorages in important structures. It seeks to raise awareness towards dynamic anchor design problems, show how to classify, model and calculate them, and finally suggest an appropriate Hilti solution.

Static vs. dynamic actions

Static actions (loads and displacements) do not change in magnitude or position over time. Actions that vary sufficiently slowly with respect to time (quasi-static) are also commonly referred to as static actions. Examples of typical static actions include:





- Self weight (dead load) of an element
- Permanent actions:
 - Loads from permanent non load-bearing components (floor coverings, screed, etc)
 - Loads arising from persistent constraints (expansion/shrinkage, sinking of supports, etc.)
- Changing actions:
 - Working loads (live loads)
 - Snow
 - Wind
 - Temperature

Dynamic actions vary in magnitude and/or position over time and thereby cause non-negligible inertial and damping forces to arise.

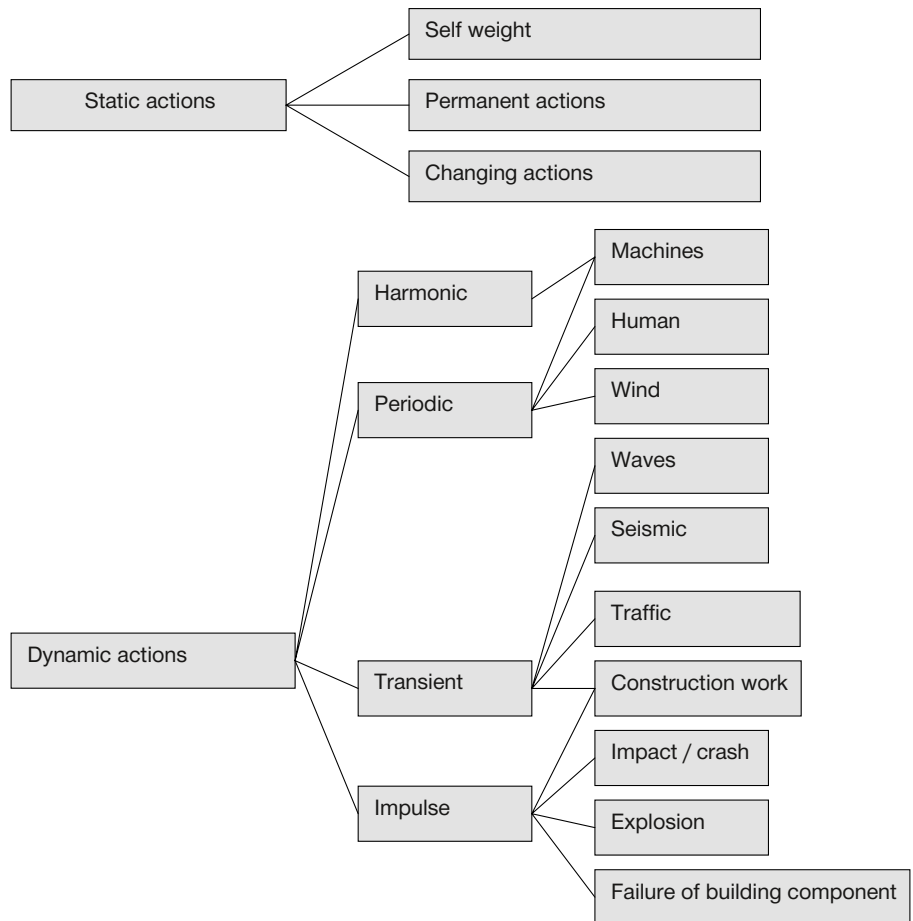
Dynamic actions may be further distinguished by the characteristics (chronological sequence) of the variation with time (Harmonic, Periodic, Transient, Impulse) as well as by the rate of variation and number of cycles (Fatigue, Seismic, Shock).

Classification	Fatigue	Seismic	Shock
Number of cycles	$10^4 < n \leq 10^8$	$10 < n < 10^4$	$1 < n < 20$
Rate of strain	$10^{-6} < \dot{\epsilon}' > 10^{-3}$	$10^{-5} < \dot{\epsilon}' > 10^{-2}$	$10^{-3} < \dot{\epsilon}' > 10^{-1}$
Examples	Traffic loads, Machines	Earthquakes	Crash, Explosion



Action	Chronological sequence	Possible cause
Harmonic (alternating)	 sinusoidal	Out of balance rotating machines
Harmonic (compressive/ tensile pulsating)	 sinusoidal	
Periodic	 random, periodic	Regularly impacting parts (punching machines)
Transient	 random, non periodic	Earthquakes/ seismic, rail and road traffic
Impulse	 random, of short duration	Impact/crash, explosion, rapidly closing valves

Definitions

As will be described in detail in the following sections, dynamic actions (loads and displacements) can generally be classified into three groups:

- Fatigue
- Seismic
- Shock

Although detailed definitions will be given in the following sections, a simple explanation of each action type is helpful at this stage:

- Fatigue actions recur frequently during the life of a structure, are often well-defined and can be anticipated.
- Seismic actions are induced by the response of a structure to an earthquake.
- Shock actions are typically unique actions that can in some cases recur during the life of the structure.

The following sections provide examples of typical applications where dynamic actions occur, and where static simplification would generally lead to significant under-design.

Fatigue applications

Two groups of fatigue type anchor loading can be distinguished:

- **Vibration loading** with very high recurrence and usually low amplitude.
- **Repeated loading and unloading** with high load amplitudes and frequent recurrence.

Vibration loading is encountered in applications such as:

- **Ventilators** (most standards and regulations assume a standard eccentricity for design purposes).
- **Production machinery** (rotating and linear).
- **Breakers** for rock, gravel and similar materials.
- **Structures subject to periodic hydraulic effects** (power plant equipment, pipe fasteners with frequent water hammer action, structures subject to water vortex loads).
- **Fastenings subject to indirect loading** through vibrating equipment at a nearby location.

The above mentioned applications are usually properly identified as “fatigue relevant” and correspondingly designed. Applications with “repeated loading and unloading” may be less obvious with regard to their dynamic relevance. Thus, an explicit objective of this brochure is to raise the awareness of the designing engineer with respect to such applications. Due to the significant loads they often include, anchors are frequently stressed close to their limits which may in turn cause failure.

Typical examples of repeated loading and unloading include:

- **Cranes** (tower cranes, workshop cranes, crane rails).
- **Elevators** (guide rails, load carrying equipment,).
- **Hoisting equipment** (hoists, fastenings of jacks).
- **Robots** and other rotating-load carrying equipment.
- **Bridge components.**
- **Loading systems** (chutes for bulk material, conveyers).

Seismic applications

In general, all anchors in structures situated in seismically active areas may be subject to seismic actions. For example, the anchorages of both the seismic load resisting system (bracing) and the so-called gravity load support system (hangers) of piping might be subject to seismic loads depending on the installation configuration. Moreover, all anchors, whether they are subject to cyclic (seismic) loads or not, might be subject to earthquake induced changes in the anchorage material (local concrete damage and crack cycling). Frequently, however, only anchorages whose failure would result in loss of human life, considerable weakening of the overall structure or significant economic losses are designed for seismic loads. It is essential to consult the relevant building code to determine the requirements for seismic anchorage applications.

Typical examples of seismic applications for anchors include:

- **Structural member connections** (these may be part of either the lateral (earthquake) load resisting system or the gravity load resisting systems).
- **Mechanical, electrical and plumbing equipment** (air conditioning units, ventilators, heavy ducts and pipes, liquid storage vessels).
- **Architectural systems** (ceilings, lighting, large signs).
- **Building content** (shelving, storage racks).

Shock applications

Shock (or impact) loads often arise in parallel to other structure loading conditions, however, sometimes they are the only load case a structure is designed for, e.g., in crash barriers and protection nets. Most commonly, shock loads occur as the result of:

- **Explosions** (in industrial plants, power stations, military use)
- **Falling parts** (as a result of seismic actions, failure of structures, expected failure of wearable parts as is the case with rubber noise insulators for machinery)
- **Extraordinary traffic loads** (crash barriers)
- **Hydraulic loads** (water hammer, extraordinary operating conditions in hydraulic structures)

It should be emphasised that shock loads are far more frequent than often assumed. Furthermore, the load increases can be dramatic and might exceed 100 times the static load.

Safety factors

In some situations, it is not possible to accurately determine the actions that will act on an anchor. In these cases, it is possible to use estimates for which design standards specify the minimum levels to be used for most types of loading. The uncertainty in determining an action is compensated by selecting suitably adapted safety factors.

2. Fatigue

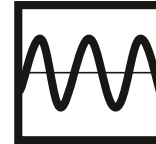

2.1 Definition of fatigue load

Actions causing fatigue have a large number of load cycles which produce changes in stress in the affected fastening. These stresses result in a decrease in strength which is all the greater the larger the change in stress and the larger the number of load cycles are (fatigue). When evaluating actions causing fatigue, not only the type of action, but also the planned or anticipated fastening life expectancy is of major importance.

Direct / indirect action

A direct action on a fastening exists when the fastening is immediately stressed by forces, e.g. due to a machine in operation. A machine in operation sets up vibration in its vicinity, also through its supports, which then indirectly incites building component vibration. This can lead to fatigue stressing of fastenings.

Determination of actions causing fatigue

In most cases, the magnitude of action causing fatigue cannot be determined accurately. When determining the fatigue relevant magnitude of an action to which a fastener is subjected, it is important, however, to remember that also the actions not occurring at the same time summate. From a design/static point of view, the actions occurring at different times are regarded separately. In the case of fatigue-relevant loading, all applicable loads must be determined over the anticipated fastening life expectancy. The following chart is intended to illustrate this:

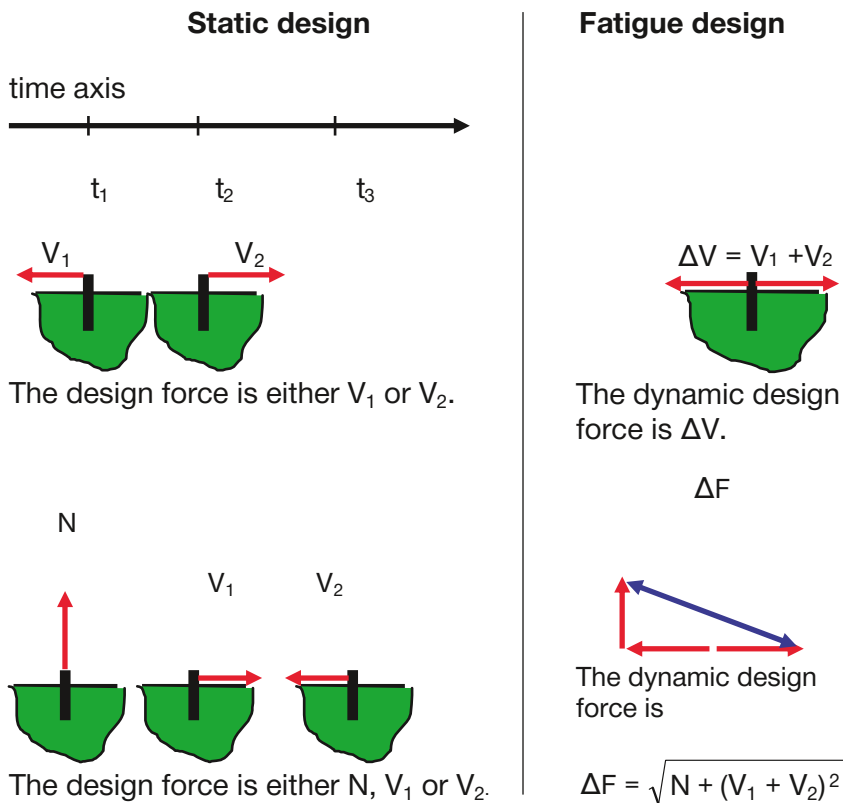

2.2 Materials under fatigue load

Material behaviour under static loading

The behaviour of material under static loading is described essentially by the strength (tensile and compressive) and the elastic-plastic behaviour of the material, e.g. modulus of elasticity, shear (lateral) strain under load, etc. These properties are generally determined by carrying out simple tests with specimens.

Fatigue behaviour

If a material is subjected to a sustained load that changes with respect to time, it can fail after a certain number of load cycles even though the upper limit of the load withstood up to this time is clearly lower than the ultimate tensile strength under static loading. This loss of strength is referred to as material fatigue.

It is widespread practice to depict the fatigue behaviour of a material in the form of so-called S-N curves (also called Wöhler curves). They show the maximum load amplitude that can be withstood at a given number of load cycles (for action with a sinusoidal pattern). If a level of stress can be determined at which failure no longer occurs after any number of load cycles, reference is made to fatigue strength or short-term fatigue strength. Higher loads that can often only be withstood for a limited time, come within the low-cycle fatigue range or range of fatigue strength for finite life.

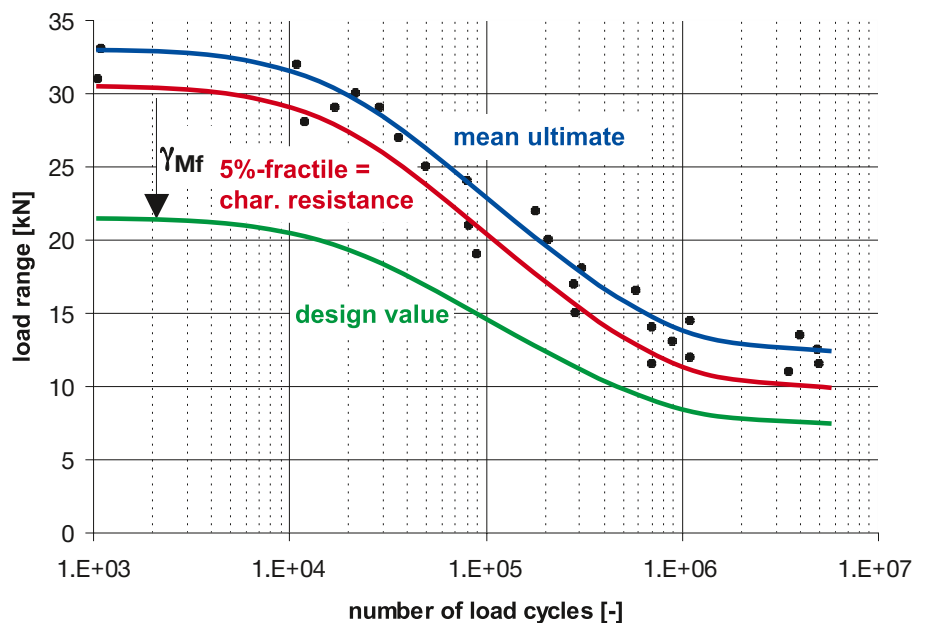

Fatigue behaviour of steel

The fatigue behaviour of various grades of steel is determined during fatigue (Wöhler) tests. If a series of fatigue tests is carried out using different mean stresses, many fatigue curves are obtained from which a decrease in the fatigue-resisting stress amplitude, σ_A , can be identified. The graphical depiction of the relationship between the mean stress, σ_m , and the fatigue-resisting stress amplitude, σ_A , in each case is called the Smith diagram.

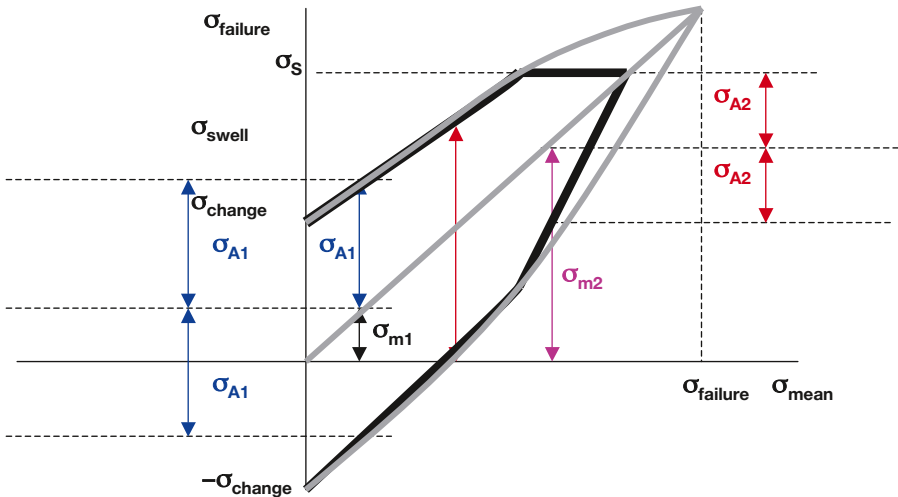

The grade of steel has a considerable influence on the alternating strength. In the case of structural and heat-treatable steels, it is approx. 40% of the static strength, but this, of course, is considerably reduced if there are any stress raisers (notch effects). The fatigue strength of actual building components such as anchors is influenced by many additional factors such as:

- Stress raiser (notch effect)
- Type of loading (tensile, shear, bending)
- Dimensions
- Mean stress

Stainless steels as well as plastics do not have a pronounced fatigue durability (endurance) so that fatigue failure can even occur after load cycles of $>10^7$.

Fatigue behaviour of anchor adhesives

Fatigue tests on adhesive anchors usually result in failure of the steel. The decrease of steel strength is clearly more pronounced than the decrease of bond strength. After 2 Million load cycles the bond strength is usually higher than 65% of its initial value. However in adverse conditions such as anchors set into wet, diamond cored holes the bond strength after fatigue loading showed a large scatter and values as low as 40% of the initial value have been measured.

Fatigue behaviour of concrete

The failure mode of concrete under fatigue loading is the same as under static loading. In the non-loaded state, concrete already has micro-cracks in the zone of contact of the aggregates and the cement paste which are attributable to the aggregates hindering shrinkage of the cement paste. The fatigue strength of concrete is directly dependent on the grade of concrete. A concrete with a higher compressive strength also has higher fatigue strength. Concrete strength is reduced to about 60 – 65% of the initial strength after 2'000'000 load cycles.

2.3 Anchor behaviour

Fatigue behaviour of single anchor in concrete

The fatigue behaviour of steel and concrete is described in chapter 2.2. When a large number of load cycles is involved, i.e. $n > 10^4$, it is always the anchor in single fastenings that is crucial (due to steel failure). The concrete can only fail when an anchor is at a reduced anchorage depth and subjected to tensile loading or an anchor is at a reduced distance from an edge and exposed to shear loading.

In the range of short-term strength, i.e. $n < 10^4$, the concrete can also be crucial. This is dependent very much on the cross-sectional area of the steel in relation to the anchorage depth, i.e. a large diameter combined with a small anchorage depth → concrete failure or a small diameter with a large anchorage depth → steel failure.

Multiple anchor fastenings

Individual anchors in a multiple-anchor fastening can have a different elastic stiffness and a displacement (slip) behaviour that differs from one anchor to another, e.g. if an anchor is set in a crack. This leads to a redistribution of the forces in the anchors during the appearance of the load cycles. Stiffer anchors are subjected to higher loads, whereas the loads in the less stiff anchors are reduced. Allowance is made for these two effects by using a reduction factor for multiple-anchor fastenings. It is determined during defined tests.

Influence of anchor pretensioning

The behaviour of anchors under dynamic loading is decisively improved by anchor pretensioning (preload). If an external working load, F_A , acts on a pretensioned anchor fastening, the fatigue-relevant share of the load cycle taken by the bolt is only the considerably smaller share of the force in the bolt, F_{SA} .

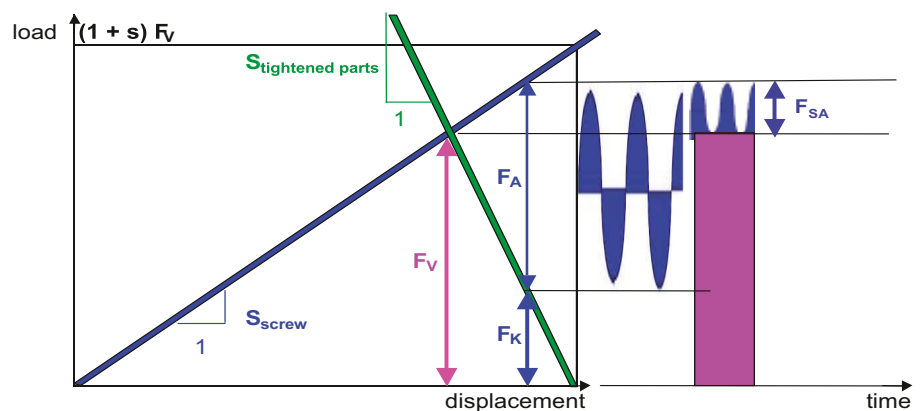

F_A : external working load

F_K : clamping force

F_{SA} : share relevant to fatigue

F_V : pretensioning force

S_{screw} : bolt stiffness

$S_{clamped\ parts}$: stiffness of clamped parts

Therefore, the existence of a pretensioning force is of crucial significance for the fatigue behaviour of an anchor (fastener). In the course of time, however, all anchors lose some of the pretensioning force. This loss is caused by creep of the concrete, primarily in the zone in which the load is transferred to the concrete, due to relative deformation in turns of the bolt thread and relaxation in the bolt shank.

Tests have shown that comparable losses of pretensioning force can be measured in anchors (fasteners) that have quite different anchoring mechanisms, such as cast-in headed studs, undercut anchors and expansion anchors. As a result, a residual pre-

tensioning force of 30 to 50% the initial force must be expected after a considerable time if no counter-measures are taken. It is recommended to retighten the torque on the first and second days after the installation and then every 1 to 3 years.

Pretensioning force of anchor in a crack

If a crack opens at the location of an anchor, the pretensioning force may decrease to zero and cannot, consequently, be taken into account for a fastening being designed to withstand fatigue.

Influence of pretensioning on anchors loaded in shear

The clamping force between the part fastened and the base material, as shown above, is directly dependent on the pretensioning force in the anchor. As a rule, the fatigue strength of steel under shear loading is not as high as under pure tensile loading. In view of this, an attempt should be made to transfer at least a part of the dynamic shear force into the concrete by friction. Accordingly, if the pretensioning force is high, the share that the anchor must take up is smaller. This has a considerable influence on the number and size of anchors required.

Pretensioning force in stand-off fastenings

In stand-off fastenings, the section of the bolt above the concrete is not pretensioned. The type of threaded rod alone, i.e. rolled after heat treatment or tempered after heat treatment, thus determines the fatigue durability of the fastenings. The pretensioning force in anchors is, nevertheless, important to achieve a high level of fastening stiffness.

Influence of type of thread

The way the thread is produced has a decisive influence on its fatigue strength. A thread rolled after bolt heat treatment has a higher fatigue strength than a thread tempered after heat treatment. All threads of Hilti anchors are rolled after heat treatment. Similarly, the diameter of a thread has a decisive influence on the ultimate strength. This decreases with increasing diameter.

Suitability under fatigue loading

Both mechanical and chemical anchors are basically suitable for fastenings subjected to fatigue loading. As, first and foremost, the grade of steel is crucial, Hilti manufactures the HDA and HVZ anchors of special grades of steel resistant to fatigue and has also subjected them to suitably tests. Where other anchors are concerned, global statements about ultimate strengths have to be relied on, e.g. those from mechanical engineering.

2.4 Anchor design for fatigue

2.4.1 Design load

For design purposes, the variable fatigue loads as shown in sections 1 and 2.2 often need to be described as repeated changes between a minimum and a maximum load level. The smallest, continuously acting load is called the static load F ; the difference between the continuously acting load F and the maximum load is the fatigue-relevant part of the load ΔF . For shear loads the fatigue-relevant load ΔV acts directly on the fastener if the friction between base plate and base material is exceeded. For tensile loads the fatigue relevant part of the external load ΔN in the bolt has to be determined.

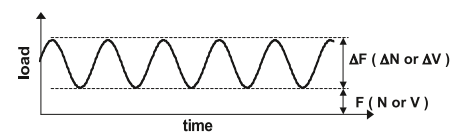

For a simplified design according to the DIBt-approval all loads are assumed to be fatigue relevant ($\Delta F = F + \Delta F$), friction and the pretension force in the anchor are not considered ($= 0$).

2.4.2 Prestressing force in the anchor

The prestressing force in uncracked concrete that can be taken into account respecting all the long term effects is:

$$F_{B,d} = \frac{k_1 \cdot M_d \cdot k_\infty}{k_u \cdot d}$$

with

- $F_{B,d}$ pretension force in the anchor
- k_1 factor determined in tests = 0.5
- M_d tightening torque [Nm]
- k_∞ long term factor
 - without poststressing: 0.3 for HDA and 0.2 for HVZ
 - with regular poststressing: 0.4 for HDA and 0.3 for HVZ
- k_u conversion factor = 0.3
- d nominal anchor diameter [mm]

In a crack the pretension force vanishes and is therefore equal to 0.

2.4.3 Fatigue relevant part of the force in the anchor

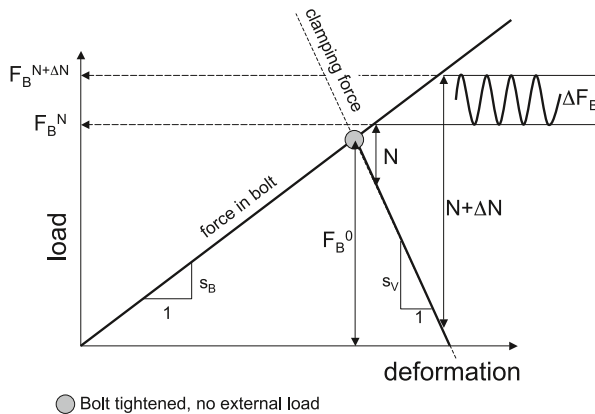

force in bolt:

- at static load N:

$$\text{if } N \geq F_B^0 \cdot (1 + s): F_B^N = N$$

$$\text{if } N < F_B^0 \cdot (1 + s): F_B^N = F_B^0 + N \cdot \frac{s}{1 + s}$$

- at maximum load N + ΔN:

$$\text{if } N + \Delta N \geq F_B^0 \cdot (1 + s): F_B^{N+\Delta N} = N + \Delta N$$

$$\text{if } N + \Delta N < F_B^0 \cdot (1 + s): F_B^{N+\Delta N} = F_B^0 + (N + \Delta N) \cdot \frac{s}{1 + s}$$

$$s = s_B / s_V$$

based on different studies, $s = 0.67$ can be assumed

fatigue-relevant tensile force in bolt: $\Delta F_B = F_B^{N+\Delta N} - F_B^N$

minimum clamping force: $N_{k,min} = F_B^{N+\Delta N} - (N + \Delta N)$

The friction resistance is: $V_{Rd} = N_{k,min} \cdot \mu$

$N_{k,min}$ minimum clamping force

μ friction coefficient = 0.2

If maximum shear force $V_E + \Delta V_E \leq V_{Rd}$, then the acting force on the anchor $\Delta V = 0$, otherwise the total external force is assumed to act on the anchor $\Delta V = \Delta V_E$.

2.4.4 Static resistance

The resistance against the highest occurring load will be checked with a static design to normal anchor design in accordance with national and international regulations and approvals (ETA, ICC-ES, etc).

2.4.5 Fatigue resistance

In general the fatigue design should be done for the fatigue-relevant part of the external force ΔF and the relevant number of load cycles n .

$$\Delta F_{Rd}(n) > \Delta F_d$$

For simplified design the number of load cycles is $n \geq 2'000'000$ and the total load is fatigue-relevant.

For tensile and shear forces the resistances for steel and concrete fatigue should be determined. These values ($\Delta N_{Rd,s}$, $\Delta N_{Rd,c}$, $\Delta V_{Rd,s}$, $\Delta V_{Rd,c}$) are identified with tests for each number of load cycles (Wöhler Curves).

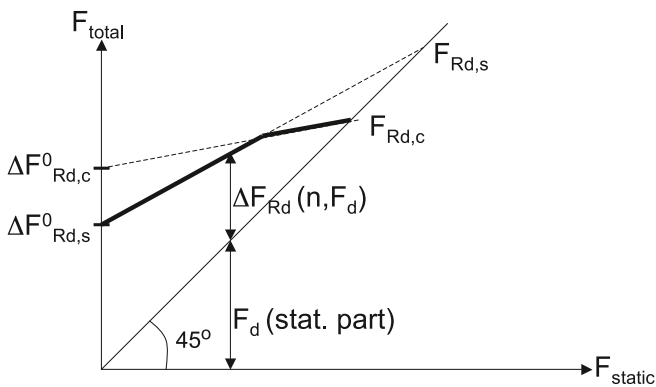

$$\Delta N_{Rd} = \min \left\{ \begin{array}{l} \Delta N_{Rd,s}^0 + (N_{Rd,s} - \Delta N_{Rd,s}^0) \cdot \frac{N_d}{N_{Rd,s}} - N_d \\ \Delta N_{Rd,c}^0 + (N_{Rd,c} - \Delta N_{Rd,c}^0) \cdot \frac{N_d}{N_{Rd,c}} - N_d \end{array} \right\}$$

$$\Delta V_{Rd} = \min \left\{ \begin{array}{l} \Delta V_{Rd,s}^0 + (V_{Rd,s} - \Delta V_{Rd,s}^0) \cdot \frac{V_d}{V_{Rd,s}} - V_d \\ \Delta V_{Rd,c}^0 + (V_{Rd,c} - \Delta V_{Rd,c}^0) \cdot \frac{V_d}{V_{Rd,c}} - V_d \end{array} \right\}$$

For group fastenings a group factor has to be taken into account, which gives the increase for the most loaded anchor due to load redistribution from the more flexible to the stiffer anchors.

2.4.6 Simplified estimation of fatigue resistance

For certain anchors the available fatigue resistance data do not allow a complete design as shown in sections 2.4.2 to 2.4.5, but still they have been shown to be able to take up fatigue loads by laboratory testing. Based on considerations about the material behaviour under fatigue loads (see section 2.2) the following approach can be taken:

- After 2 million load cycles, the remaining steel strength of carbon steel anchors is 25 % – 35 % of the initial strength.
- concrete and bond strength are reduced to roughly 55 % – 65 % of the initial strength

Based on these considerations, the design can be done as static design in Profis Anchor and for carbon steel anchors (galvanized, hot dipped galvanized and sherardized) it must be checked that the usage against steel failure does not exceed 25 % and the usage against all other failure modes does not exceed 55 %.

For stainless steel anchors, there is no clear fatigue limit. If the number of load cycles considered does not exceed 2 million, this approach is on the safe side for stainless steel; otherwise a further reduced steel capacity may need to be considered, depending on the specific material properties.

2.5 Product information: Fatigue

The following anchor resistances for tensile, shear and combined loads are the approved values from the DIBt (Deutsches Institut für Bautechnik). This product information is only valid together with the general product information given in the Fastening Technology Manual FTM.

In addition to this the dynamic set (Appendix A) has to be used.

For the design the following assumptions have to be taken into consideration:

- all applied loads are fatigue relevant
- load safety factor $\gamma_F = 1.0$
- for group fixings a group factor has to be considered (redistribution of loads in the anchor group)
- number of load cycles $n \geq 2'000'000$
- design with reduced anchor spacings, edge distances or other concrete qualities is done according to the Fastening Technology Manual or with the Profis Anchor design program
- the concrete resistance has to be reduced

2.5.1 Product information HDA

The DIBt-approval specifies the characteristic steel and pullout resistances under fatigue loads as reproduced below. The concrete related failure modes are taken into account by specifying the percentage of the static resistance which can be taken into account under fatigue loads.

Basic load data according to DIBt-approval Z-21.1-1693 for HDA dynamic of April 12, 2007

Characteristic resistances ΔR_k [kN]: concrete C20/25 (according DIBt)

Anchor	M10	M12	M16
Tensile $\Delta N_{Rk,s}$ HDA-P and HDA-P	10	17.5	17.5
Tensile $\Delta N_{Rk,p}$ HDA-P and HDA-P	16	22	48
Tensile: usage for concrete cone and splitting:	$\Delta N_{Rk,c} = 0.64 \cdot N_{Rk,c}$		
Shear $\Delta V_{Rk,s}$ HDA-P	2.5	6.0	8.0
Shear $\Delta V_{Rk,s}$ HDA-T	8.5	15	23
Shear: usage for pryout	$\Delta V_{Rk,cp} = 0.64 \cdot V_{Rk,cp}$		
Shear: usage for concrete edge	$V_{Rk,c} = 0.64 \cdot V_{Rk,c}$		

material safety factors: $\gamma_{MsN} = 1.5$; $\gamma_{MsV} = 1.35$; $\gamma_{Mp} = 1.35$; $\gamma_{Mc} = 1.35$; $\gamma_{Mcp} = 1.35$

Group factors: Tension: $\gamma_{F,N}$ / **Shear:** $\gamma_{F,V}$

$\gamma_{F,N} = \gamma_{F,V} = 1.0$ for single anchor

$\gamma_{F,N} = 1.3$ $\gamma_{F,V} = 1.2$ for more than one anchor

Detailed design tables:

Tension loading

The tensile design resistance ΔN_{Rd} of a single anchor is the minimum of:

Steel resistance: $\Delta N_{Rd,s}$

pull out resistance (in cracked concrete): $\Delta N_{Rd,p} = \Delta N_{Rd,p}^0 \cdot f_B$

concrete cone resistance: $\Delta N_{Rd,c} = \Delta N_{Rd,c}^0 \cdot f_B \cdot f_{1,N} \cdot f_{2,N} \cdot f_{3,N} \cdot f_{re,N}$

splitting resistance (in uncracked concrete):

$\Delta N_{Rd,sp} = \Delta N_{Rd,c}^0 \cdot f_B \cdot f_{1,sp} \cdot f_{2,sp} \cdot f_{3,sp} \cdot f_{3,N} \cdot f_{h,sp} \cdot f_{re,sp}$

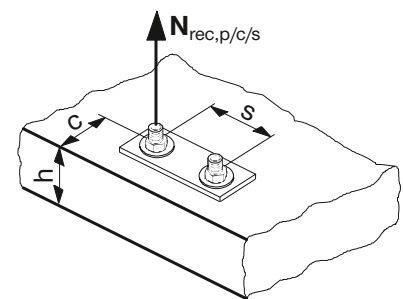

Steel tensile design resistance

Anchor size HDA-T/HDA-P	M10	M12	M16
$\Delta N_{Rd,s}$ [kN]	6.7	11.7	22.7

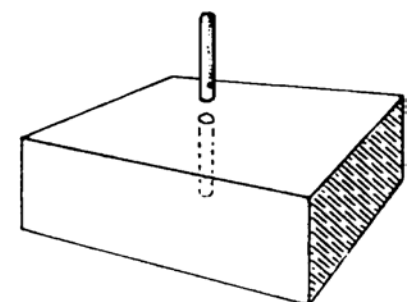

Concrete pull-out resistance (only in cracked concrete)

- concrete C20/25

Anchor size HDA-T/HDA-P	M10	M12	M16
$\Delta N_{Rd,p}^0$ ¹⁾ [kN] in cracked concrete	11.9	16.3	35.6

¹⁾ The initial value of the tensile design load against pull out is calculated from $\Delta N_{Rd,p}^0 = \Delta N_{Rk,p}^0 / \gamma_{Mc}$, where the partial safety factor for concrete is $\gamma_{Mp} = 1.35$. The displacement is smaller than $d_{95\%} \leq 3$ mm after 1000 crack cycles ($w = 0.3$ mm).

Concrete cone resistance

- concrete C20/25

Anchor size HDA-T/HDA-P	M10	M12	M16
$\Delta N_{Rd,c}^0$ ¹⁾ [kN] in cracked concrete $w = 0.3$ mm	19.7	27.5	51.5
$\Delta N_{Rd,c}^0$ ¹⁾ [kN] in uncracked concrete	27.5	38.5	72.1

¹⁾ The value of the tensile design load against concrete coin failure is calculated from $\Delta N_{Rd,c}^0 = \Delta N_{Rk,c}^0 / \gamma_{Mc}$, where the partial safety factor for concrete is $\gamma_{Mc} = 1.35$, with $\Delta N_{Rk,c}^0 = 64\% N_{Rd,c}^0$.

The critical edge distances and spacings $s_{cr,sp}$, $c_{cr,sp}$, $s_{cr,N}$, $c_{cr,N}$ as well as the influencing factors f_B , f_1 , N , f_2 , N , f_3 , N , $f_{re,N}$, $f_{1,sp}$, $f_{2,sp}$, $f_{3,sp}$, $f_{3,N}$, $f_{h,sp}$, $f_{re,sp}$ are to be calculated according to the applicable Fastening Technology Manual.

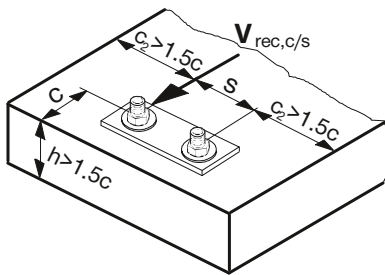

Shear loading

The shear design resistance ΔV_{Rd} of a single anchor is the minimum of:

Steel resistance: $\Delta V_{Rd,s}$

pryout resistance: $\Delta V_{Rd,cp}^0 = \Delta V_{Rd,cp}^0 \cdot f_B \cdot f_{1,N} \cdot f_{2,N} \cdot f_{3,N} \cdot f_{re,N}$

concrete edge resistance: $\Delta V_{Rd,c}^0 = \Delta V_{Rd,c}^0 \cdot f_B \cdot f_\beta \cdot f_h \cdot f_4$

Steel shear design resistance

Anchor size HDA-T/HDA-P	M10	M12	M16
$\Delta V_{Rd,s}$ ¹⁾ [kN]			
HDA-T	6.3	11.1	17.0
HDA-P	2.0	4.4	5.9

¹⁾ The shear design resistance is calculated from $\Delta V_{Rd,s} = \Delta V_{Rk,s} / \gamma_{Ms,V}$. The partial safety factor $\gamma_{Ms,V}$ for HDA-T is equal to 1.5 and 1.25 for HDA-P.

Concrete pryout resistance (only in cracked concrete)

- concrete C20/25

Anchor size HDA-T/HDA-P	M10	M12	M16
$V_{Rd,cp}^0$ ¹⁾ [kN] in cracked concrete	28.2	39.3	73.8

¹⁾ The design value of the ultimate state in shear $\Delta V_{Rd,cp}^0$ is calculated from the characteristic anchor shear resistance, $\Delta V_{Rk,cp}^0$ divided by $\gamma_{Mc,v}$ where the partial safety factor, $\gamma_{Mc,v}$ is 1.62 and $\Delta V_{Rk,cp}^0 = 55\% V_{Rk,cp}$

Concrete edge resistance

- concrete C20/25
- at minimum edge distance c_{min}

Anchor size HDA-T/HDA-P	M10	M12	M16
c_{min} ¹⁾ [mm] minimum edge distance	80	100	150
$V_{Rd,c}^0$ ¹⁾ [kN] in cracked concrete $w = 0.3$ mm	3.1	4.6	9.5

¹⁾ The design value of the ultimate state in shear $\Delta V_{Rd,c}^0$ is calculated from the characteristic anchor shear resistance, $\Delta V_{Rk,c}^0$ divided by $\gamma_{Mc,v}$ where the partial safety factor, $\gamma_{Mc,v}$ is 1.62 and $\Delta V_{Rk,c}^0 = 55\% V_{Rk,c}$

The critical edge distances and spacings s_{critN} , c_{critN} as well as the influencing factors f_B , f_1 , $f_{2,N}$, $f_{3,N}$, $f_{re,N}$, f_β , f_h , f_4 are to be calculated according to the applicable Fastening Technology Manual.

steel: $\frac{\Delta N_{Sd}^h}{\Delta N_{Rd,s}} + \frac{\Delta V_{Sd}^h}{\Delta V_{Rd,s}} \leq 1.0$ **highest loaded single anchor**

concrete: $\frac{\Delta N_{Sd}^g}{\Delta N_{Rd,c}^g} + \frac{\Delta V_{Sd}^g}{\Delta N_{Rd,c}^g} \leq 1.0$ **anchor group**

2.5.2 Product information HVZ

The DIBt approval covers the sizes M10, M12 and M16. The detailed tables of design values also give recommendations for size M20 based on internal testing..

Basic load data according to DIBt-approval Z-21.3-1692 for HAS-TZ dynamic of October 18, 2008

Characteristic resistances ΔR_k [kN]: : concrete C20/25 (according DIBt)

Anchor HVZ with HAS-TZ	M10x75	M12x95	M16x105	M16x125
Tensile $\Delta N_{Rk,s}$	10	18	20	26
Tensile $\Delta N_{Rk,p,cr}$ in cracked concrete	12	21	24	30
Tensile $\Delta N_{Rk,p,ucr}$ in uncracked concrete	15	24	30	36
Tensile: usage for concrete cone and splitting:	$\Delta N_{Rk,c} = 0.60 \cdot N_{Rk,c}$			
Shear $\Delta V_{Rk,s}$ HDA-P	4.5	8.5	15	15
Shear: usage for pryout and concrete edge:	$V_{Rk,cp} = 0.60 \cdot V_{Rk,cp}$			

material safety factors: $\gamma_{MsN} = 1.35$; $\gamma_{MsV} = 1.35$; $\gamma_{Mp} = 1.5$; $\gamma_{Mc} = 1.5$; $\gamma_{Mcp} = 1$.

Group factors: Tension: $\gamma_{F,N}$ / **Shear:** $\gamma_{F,V}$

$\gamma_{F,N} = \gamma_{F,V} = 1.0$ for single anchor

$\gamma_{F,N} = 1.45$ $\gamma_{F,V} = 1.3$ for more than one anchor

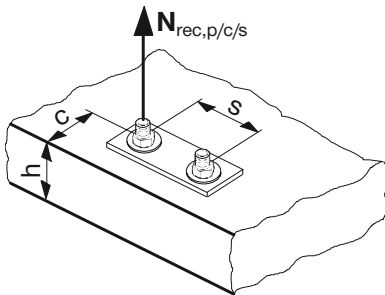

Tension loading

The tensile design resistance ΔN_{Rd} of a single anchor is the minimum of:

Steel resistance: $\Delta N_{Rd,s}$

pull out / cone resistance: $\Delta N_{Rd,p} = \Delta N_{Rd,p}^0 \cdot f_{B,p} \cdot f_{h,p}$

concrete cone resistance: $\Delta N_{Rd,c} = \Delta N_{Rd,c}^0 \cdot f_B \cdot f_{1,N} \cdot f_{2,N} \cdot f_{3,N} \cdot f_{h,N} \cdot f_{re,N}$

splitting resistance (in uncracked concrete):

$\Delta N_{Rd,sp} = \Delta N_{Rd,c}^0 \cdot f_B \cdot f_{1,sp} \cdot f_{2,sp} \cdot f_{3,sp} \cdot f_{3,N} \cdot f_{h,sp} \cdot f_{re,sp}$

$\Delta N_{Rd,s}$: Steel tensile design resistance

Anchor size	M10x75	M12x95	M16x105	M16x125	M20x170
$\Delta N_{Rd,s}^{1)}$ [kN] HAS-TZ steel grade 8.8	7.4	13.3	14.8	19.3	20.7

¹⁾ The partial safety factor, $\gamma_{MsN} = 1.35$.

$\Delta N_{Rd,p}$: Pull-out / concrete cone resistance

- concrete C20/25

Anchor size HVZ	M10x75	M12x95	M16x105	M16x125	M20x170
$\Delta N_{Rd,p}^{1)}$ [kN] in cracked concrete	8.0	14.0	16.0	20.0	29.4
$\Delta N_{Rd,p}^{1)}$ [kN] in uncracked concrete	10.0	16.0	20.0	24.0	35.6

¹⁾ The initial value of the tensile design load against pull out is calculated from $\Delta N_{Rd,p}^{\circ} = \Delta N_{Rk,p}^{\circ} / \gamma_{Mp}$, where the partial safety factor for concrete is $\gamma_{Mp} = 1.50$.

$\Delta N_{Rd,c}$: Concrete cone / splitting resistance

- concrete C20/25

Anchor size HVZ	M10x75	M12x95	M16x105	M16x125	M20x170
$\Delta N_{Rd,c}^{1)}$ [kN] in non-cracked concrete	13.1	18.7	21.7	28.3	44.8
$\Delta N_{Rd,c}^{1)}$ [kN] in cracked concrete	9.4	13.3	15.5	20.1	31.9

¹⁾ The tensile design resistance is calculated from the tensile characteristic resistance $\Delta N_{Rk,c}^{\circ} = 60\% N_{Rk,c}$ by $\Delta N_{Rd,c}^{\circ} = \Delta N_{Rk,c}^{\circ} / \gamma_{Mc,N}$, where the partial safety factor $\gamma_{Mc,N}$ is equal to 1.50.

The critical edge distances and spacings $s_{cr,sp}$, $c_{cr,sp}$, $s_{cr,N}$, $c_{cr,N}$ as well as the influencing factors f_B , $f_{1,N}$, $f_{2,N}$, $f_{3,N}$, $f_{re,N}$, $f_{1,sp}$, $f_{2,sp}$, $f_{3,sp}$, $f_{3,N}$, $f_{h,sp}$, $f_{re,sp}$ are to be calculated according to the applicable Fastening Technology Manual.

Shear loading

The shear design resistance ΔV_{Rd} of a single anchor is the minimum of:

Steel resistance: $\Delta V_{Rd,s}$

prout resistance: $\Delta V_{Rd,cp} = \Delta V_{Rd,cp}^{\circ} \cdot f_B \cdot f_{1,N} \cdot f_{2,N} \cdot f_{3,N} \cdot f_{re,N}$

concrete edge resistance: $\Delta V_{Rd,c} = \Delta V_{Rd,c}^{\circ} \cdot f_B \cdot f_{\beta} \cdot f_h \cdot f_4$

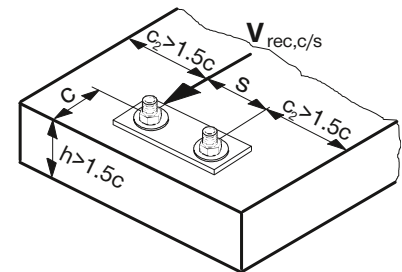

$\Delta V_{Rd,s}$: Steel shear design resistance

Anchor size	M10x75	M12x95	M16x105	M16x125	M20x170
$\Delta V_{Rd,s}^{1)}$ [kN] HAS-TZ steel grade 8.8	3.3	6.3	11.1	11.1	11.1

¹⁾ The design shear resistance is calculated using $\Delta V_{Rd,s} = V_{Rk,s} / \gamma_{Ms,V}$ where the partial safety factor $\gamma_{Ms,V} = 1.35$.

$\Delta V_{Rd,c}$: Concrete prout design resistance (only in cracked concrete)

- concrete C20/25

Anchor size	M10x75	M12x95	M16x105	M16x125	M20x170
$\Delta V_{Rd,c}^{1)}$ [kN] in cracked concrete	18.7	26.6	31.0	40.2	63.8

¹⁾ The design value of the ultimate state in shear is calculated from the characteristic anchor shear resistance, $\Delta V_{Rk,c}^{\circ} = 60\% V_{Rk,c}^{\circ}$ divided by $\gamma_{Mc,V}$ where the partial safety factor, $\gamma_{Mc,V}$ is 1.5.

$\Delta V_{Rd,c}$: Concrete edge design resistance at c_{min}

- concrete C20/25

Anchor size HVZ	M10x75	M12x95	M16x105	M16x125	M20x170
$\Delta V_{Rd,c}^0$ ¹⁾ [kN] in non-cracked concrete	2.2	4.0	5.9	6.2	6.6
$\Delta V_{Rd,c}^0$ ¹⁾ [kN] in cracked concrete		14.0	16.0	20.0	29.4
c_{min} [mm] Min. edge distance	60	75	85		4.7

¹⁾ The design value of the ultimate state in shear is calculated from the characteristic anchor shear resistance, $\Delta V_{Rk,c}^0 = 60\% V_{Rk,c}^0$ divided by $\gamma_{Mc,V}$, where the partial safety factor, $\gamma_{Mc,V}$ is 1.5.

Combined loads

steel: $\left(\gamma_{FN} \cdot \frac{\Delta N_{Sd}^h}{\Delta N_{Rd,s}} \right)^\alpha + \left(\gamma_{FV} \cdot \frac{\Delta V_{Sd}^h}{\Delta V_{Rd,s}} \right)^\alpha \leq 1.0$ highest loaded single anchor
with $\alpha=0.75$ (M10); $\alpha=0.80$ (M12);
 $\alpha=1.0$ (M16, M20)

concrete: $\frac{\Delta N_{Sd}^g}{\Delta N_{Rd,c}^g} + \frac{\Delta V_{Sd}^g}{\Delta V_{Rd,c}^g} \leq 1.0$ anchor group

pullout $\gamma_{FN} \cdot \frac{\Delta N_{Sd}^h}{\Delta N_{Rd,p}} \leq 1.0$

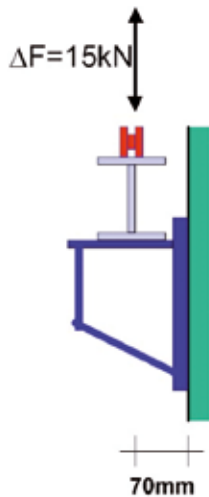

Cross section

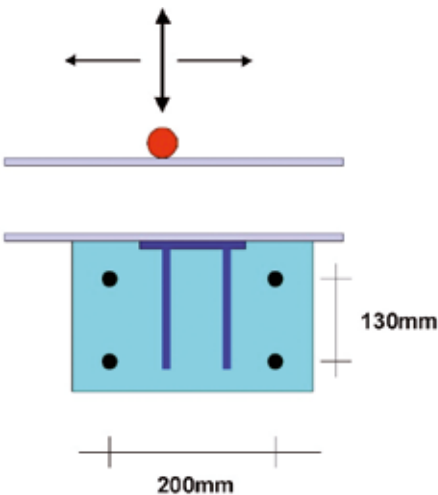

View

2.5.3 Other anchors

Fatigue tests have been performed on other anchors as well. Those test reports are valid for the tested configurations and can therefore not be extrapolated to different situations without appropriate engineering judgement. To check if a specific anchor is suitable for fatigue and which fatigue tests were performed on it, please contact the Hilti Technical Service.

Anchors which have been tested to be suitable for fatigue loads can be designed according to section 2.4.6 or using the data given in the corresponding test reports.

2.6 Design examples: Fatigue

2.6.1 Simplified design for the fixing of crane track with dynamic loads in a concrete member

Given:

- Hilti design anchor HDA-T M12, anchoring in cracked concrete,
- concrete strength class: C25/30
- applied shear load: $S_k = 15$ kN (max. load)
- thickness of concrete member: $h > 250$ mm
- spacing: $s_1 = 200$ mm, $s_2 = 130$ mm
- length of anchor plate: $\ell_x = 300$ mm
- width of anchor plate: $\ell_y = 230$ mm
- number of load cycle $n = 2'000'000$

Static check

load safety factor $\gamma_Q = 1.5$

$$V_{yd} = 15.0 \cdot 1.5 = 22.5kN, M_{xd} = 22.5kN \cdot 0.07m = 1.6kNm$$

Profis Anchor 2.0 results for HDA-T M12:

Tension:

steel failure: $\frac{N_{Sd}}{N_{Rd,s}} = 0.10$

Pullout failure: $\frac{N_{Sd}}{N_{Rd,p}} = 0.18$

Concrete cone failure: $\frac{N_{Sd}}{N_{Rd,c}} = 0.15$

Splitting failure: not relevant in cracked concrete

Shear:

steel failure: $\frac{V_{Sd}}{V_{Rd,s}} = 0.08$

Pryout failure: $\frac{V_{Sd}}{V_{Rd,cp}} = 0.13$

combined load: $\beta_{N,V} = 0.12$

Simplified fatigue check

Assumptions:

- all loads fatigue relevant
- no prestressing force in anchor
- stiff baseplate
- $\gamma_{FN} = \gamma_{FV} = 1.0$ (load safety factor for single anchor)
- $\gamma_{FN} = 1.3$ (group factor for tensile load)
- $\gamma_{FV} = 1.2$ (group factor for shear load)

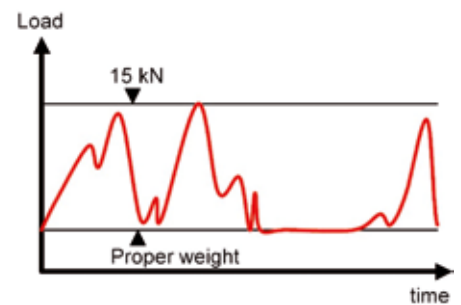

Fatigue relevant loads

single anchors

tensile load on upper single anchor in upper row = highest loaded anchor (out of static calculation):

$$\Delta N_{sd}^h = \gamma_{F,N} \frac{N_{Sd}^h}{\gamma_Q} = 1.3 \cdot \frac{4.6kN}{1.5} = 4.0kN$$

tensile load on lower anchor row: $\Delta N_{sd}^l = \gamma_{F,N} \frac{N_{Sd}^l}{\gamma_Q} = 1.3 \cdot \frac{0.5kN}{1.5} = 0.4kN$

Total tensile load anchor group for concrete cone check (without $\gamma_{F,N}$)

$$\Delta N_{Sd}^g = 2 \cdot \frac{N_{Sd}^h}{\gamma_{F,N}} + 2 \cdot \frac{N_{Sd}^l}{\gamma_{F,N}} = 2 \cdot \frac{4.0kN}{1.3} + 2 \cdot \frac{0.4kN}{1.3} = 6.8kN$$

$$\text{shear load on single anchor: } \Delta V_{Sd} = \gamma_{F,V} \frac{V_{Sd}}{n \cdot \gamma_Q} = 1.2 \cdot \frac{22.5kN}{4 \cdot 1.5} = 4.5kN$$

with n: number of anchors in anchor group

Resistance

Tension

Steel failure (check only with highest loaded anchor):

tensile steel resistance single anchor: $\Delta N_{Rd,s} = 11.7kN$

$$\text{Check single anchor: } \frac{\Delta N_{Sd}^h}{\Delta N_{Rd,s}} = \frac{4.0kN}{11.7kN} = 0.34 \quad \text{ok}$$

Concrete cone failure (check only with anchor group):

$$\text{static group resistance: } N_{Rk,c}^g = N_{Rk,c}^0 \cdot \frac{A_{c,N}}{A_{c,N}^0} \cdot \psi_{s,N} \cdot \psi_{ec,N} \cdot \psi_{ucr,N}$$

$$\Delta N_{Rd,c}^0 = 27.5kN \quad (\text{single undercut anchor})$$

$$A_{c,N}^0 = (s_{cr,N})^2 = (375)^2 = 140'625 \text{ mm}^2$$

$$A_{c,N} = (1.5 \cdot 120 \text{ mm} + 130 \text{ mm} + 1.5 \cdot 120 \text{ mm}) \cdot (1.5 \cdot 120 \text{ mm} + 200 \text{ mm} + 1.5 \cdot 120 \text{ mm}) = 274'400 \text{ mm}^2$$

$$\frac{A_{c,N}}{A_{c,N}^0} = 1.95$$

$$\psi_{s,N} = 1.0 \quad (\text{no edge})$$

eccentricity due to bending moment:

$$e_N = \left(\frac{4.6kN \cdot 65 \text{ mm} - 0.5kN \cdot 65 \text{ mm}}{5.1kN} \right) = 52 \text{ mm}$$

$$\psi_{ec,N} = \frac{1}{1 + 2e_N / s_{cr,N}} = 0.78 \quad (\leq 1)$$

$$\Delta N_{Rd,c}^g = 27.5 \cdot 1.95 \cdot 1.0 \cdot 0.78 = 41.8kN$$

$$\text{Check anchor group: } \frac{\Delta N_{Sd}^g}{\Delta N_{Rd,c}^g} = \frac{6.8kN}{41.8kN} = 0.16 \leq 1 \rightarrow \text{ok}$$

Pullout failure (check only with highest loaded anchor):

$$\Delta N_{Rd,p} = f_B \cdot \Delta N_{Rd,p}^0 = 1.1 \cdot 16.3kN = 17.9kN$$

with f_B : factor for influence of concrete strength for C25/30

$$\text{Check single anchor: } \frac{\Delta N_{Sd}^h}{\Delta N_{Rd,p}} = \frac{4.0kN}{17.9kN} = 0.22 \leq 1 \rightarrow \text{ok}$$

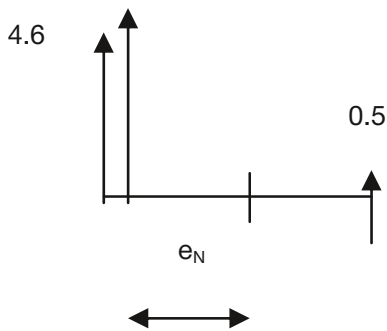

Shear

Steel failure:

shear resistance single anchor

$\Delta V_{Rd,s} = 11.1 \text{ kN}$ shear resistance of single anchor

check single anchor: $\frac{\Delta V_{Sd}^h}{\Delta V_{Rd,s}} = \frac{4.5 \text{ kN}}{11.1 \text{ kN}} = 0.4 \leq 1 \rightarrow \text{ok}$

Concrete failure: not decisive (no edges)

Interaction

Steel failure single anchor:

$\frac{\Delta N_{Sd}^h}{\Delta N_{Rd,s}} + \frac{\Delta V_{Sd}^h}{\Delta V_{Rd,s}} = \frac{4.0 \text{ kN}}{11.7 \text{ kN}} + \frac{4.5 \text{ kN}}{11.1 \text{ kN}} = 0.75 \leq 1 \rightarrow \text{ok}$

2.6.2 Simplified design for the fixing of unbalanced rotating machine in a concrete member

Given:

- Hilti undercut anchor HDA anchoring in cracked concrete,
- concrete strength class: C30/37
- proper weight of machine: $m = 400 \text{ kg}$ (max. load)
- unbalanced mass: $m_1 = 5.0 \text{ kg}$
- radius of unbalance: $r_1 = 0.5 \text{ m}$
- rotation speed: $\omega = 3'000 \text{ r/min}$
- thickness of concrete member: $h > 250 \text{ mm}$
- spacing: $s_1 = 800 \text{ mm}$
 $s_2 = 1'600 \text{ mm}$
- length of anchor plate: $\ell_x = 1'000 \text{ mm}$
- width of anchor plate: $\ell_y = 2'000 \text{ mm}$
- number of load cycle $n = 2'000'000$

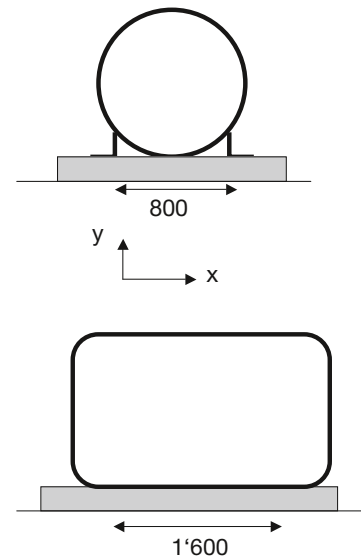

Loads

proper weight: $G = m \cdot g = 400 \text{ kg} \cdot 9.81 \frac{\text{m}}{\text{s}^2} = 3.9 \text{ kN}$

external loads due to rotating unbalanced mass

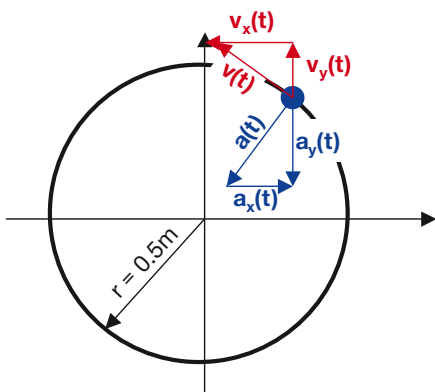

lateral:

$$a_x(t) = -\omega^2 \cdot r_1 \cdot \cos \alpha$$

$$F_{x,dyn}(t) = m_1 \cdot a_x(t) = -m_1 \cdot \omega^2 \cdot r_1 \cdot \cos \alpha$$

$$F_{x,dyn,max} = -F_{x,dyn,min} = 5.0kg \cdot \left(50 \frac{1}{s}\right)^2 \cdot 0.5m = 6.25kN$$

vertical:

$$a_y(t) = -\omega^2 \cdot r_1 \cdot \sin \alpha$$

$$F_{y,dyn}(t) = m_1 \cdot a_y(t) = -m_1 \cdot \omega^2 \cdot r_1 \cdot \sin \alpha$$

$$F_{y,dyn,max} = -F_{y,dyn,min} = 5kg \cdot \left(50 \frac{1}{s}\right)^2 \cdot 0.5m = 6.25kN$$

Static Check

maximum vertical load:

$$N_d^s = \gamma_G \cdot G + \gamma_Q \cdot F_{y,dyn} = 1.35 \cdot (-3.9kN) + 1.5 \cdot 6.25kN = 4.1kN$$

$$\text{Tensile load on single anchor: } N_d = \frac{N_d^s}{4} = 1.02kN$$

$$\text{maximum lateral load: } V_d^s = \gamma_Q \cdot F_{x,dyn} = 1.5 \cdot 6.25kN = 9.4kN$$

Shear load on single anchor:

$$V_d = \frac{V_d^s}{n} = \frac{9.4kN}{4} = 2.35kN \quad \text{with } n: \text{ number of anchors}$$

suitable anchors: HDA-P and HDA-T M10

HVZ M10

HST M10

HSL-TZ M10

HSC-A M12x60

HSC-I M10x60

Simplified Fatigue Check

Assumptions:

- all loads fatigue relevant
- no prestressing force in anchor
- stiff baseplate
- $\gamma_{FN} = \gamma_{FV} = 1.0$ (load safety factor for single anchor)

Fatigue relevant loads

single anchors

$$\Delta N_{Sd}^h = \gamma_{F,N} \cdot \frac{G + F_{y,dyn,max}}{n} = 1.0 \cdot \frac{-3.9kN + 6.25kN}{4} = 0.6kN$$

$$\Delta V_{Sd}^h = \gamma_{F,V} \cdot \frac{(F_{x,dyn,max} + |F_{x,dyn,min}|)}{n} = 1.0 \cdot \frac{(6.25kN + 6.25kN)}{4} = 3.1kN$$

Resistances

Tension

Steel Failure

tensile steel resistance single anchor HDA-T M10: $\Delta N_{Rd,s} = 6.7kN$

$$\text{check single anchor: } \frac{\Delta N_{Sd}^h}{\Delta N_{Rd,s}} = \frac{0.6kN}{6.7kN} = 0.09 \leq 1 \rightarrow \text{ok}$$

Concrete cone failure

statical resistance of single anchor

$$N_{Rk,c}^0 = 8.3 \cdot \sqrt{f_{c,cube}} \cdot h_{ef}^{1.5} = 8.3 \cdot \sqrt{37} \cdot 100^{1.5} = 50.5kN$$

$$\text{fatigue resistance: } \Delta N_{Rk,c} = N_{Rk,c} \cdot 64\% = 32.2kN$$

i.e. final concrete strength is 64% of statical concrete strength

$$\Delta N_{Rd,c} = \frac{\Delta N_{Rk,c}}{\gamma_{Mc}} = \frac{32.2kN}{1.62} = 19.9kN$$

check single anchor

$$\frac{\Delta N_{Sd}}{\Delta N_{Rd,c}} = \frac{0.6kN}{19.9kN} = 0.03 \leq 1 \rightarrow \text{ok}$$

Pullout failure

$$\Delta N_{Rd,p} = f_B \cdot \Delta N_{Rd,p}^0 = 1.22 \cdot 11.9kN = 14.5kN$$

check single anchor

$$\frac{\Delta N_{Sd}}{\Delta N_{Rd,p}} = \frac{0.6kN}{14.5kN} = 0.05 \leq 1 \rightarrow \text{ok}$$

Shear:

Steel failure

shear resistance single anchor

$$\Delta V_{Rd,s} = 6.3 \text{ kN}$$

check single anchor

$$\frac{\Delta V_{Sd}}{\Delta V_{Rd,s}} = \frac{3.1kN}{6.3kN} = 0.49 \leq 1 \rightarrow \text{ok}$$

Interaction:

Steel failure single anchor

$$\frac{\Delta N_{Sd}^h}{\Delta N_{Rd,s}} + \frac{\Delta V_{Sd}^h}{\Delta V_{Rd,s}} = 0.58 \leq 1.0 \rightarrow \text{ok}$$

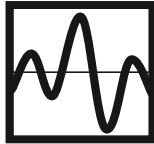

3. Earthquakes (seismic loading)

3.1 Characteristics of seismic actions

Earthquake–structure interaction and anchor loading

Earthquakes generate actions on a structure in a variety of ways. These include acceleration of the ground (ground motion), differential settlement of the foundations resulting from liquefaction or other ground phenomena and possible lateral and vertical displacement across a fault trace. From a design perspective, induced structure acceleration represents the most obvious and prevalent loading case to be considered. However, imposed deformations, not inertial forces, are frequently the cause of connection failures in earthquakes, particularly when those connections have not been designed to accommodate large deformations.

Typically, ground accelerations are translated through a structure via the foundations, which interact with the surrounding and supporting soil and rock via a complex interplay of frictional and bearing forces. The input motions from the ground generate varying responses in the structure depending on the magnitude, frequency content and duration of the ground motion, the efficiency of the soil-structure interface and the dynamic characteristics of the structure. As the structure responds to the ground motion, degradation of the primary structure, which serves as the anchorage material, can occur. In reinforced concrete structures this degradation is in large part expressed through cracking in the structural elements. Additionally, the motion of the primary structure will generate actions on secondary structures; such as structural retrofit elements or nonstructural equipment. If the secondary structure is connected to the primary structure by anchors, the motion of the primary structure generates tension and shear forces on the anchors.

Actions acting on a nonstructural anchorage under earthquake loading (source: Hoehler 2006)

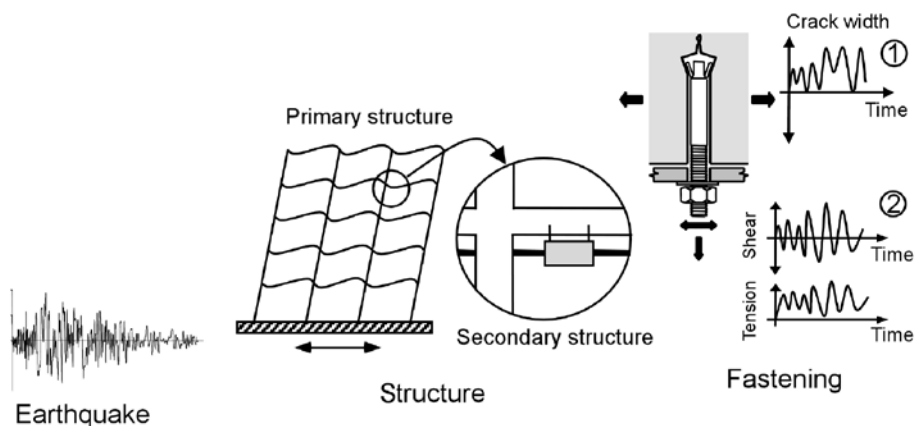

Features of seismic conditions

Seismic conditions differ from nonseismic conditions for anchorages in the following significant ways:

- The **prevalence and magnitude of cracking** in the base material typically increases, i.e., wider cracks and more of them.
- The **rate of loading** on the anchor and in the base material increases.
- **Actions vary with time (cycle)**; the relative amplitude, number and sequence of the cycles can be important.
- The magnitudes of the actions are associated with a **higher degree of uncertainty**.
- The **probability of occurrence is lower** for earthquake induced actions during the life of the structure.

3.2 Anchor behaviour under seismic actions

General

The behaviour of anchors under seismic conditions can be understood in the context of the differences to behaviour under nonseismic conditions (see **Features of seismic conditions**).

The increased prevalence and magnitude of cracking in structures during an earthquake means that, in general, anchors capable of performing reliably in large crack widths are preferable. Typical examples include, but are not limited to: headed bolts, undercut anchors, heavy sleeve anchors and bonded anchors with special expansion elements (torque-controlled bonded anchors). The larger cracks widths typically result in larger anchor displacements and a reduction of load capacity under tension load.

As in the case of impact, seismic conditions lead to increased loading rates compared to static conditions. Although behaviour under accelerated loading rate must be assessed based on the particular failure mode achieved and may be product dependent, research performed to date indicates that increased (seismic relevant) loading rate will not negatively affect the anchor load capacity and should be neglected. This conclusion holds for both cracked and uncracked concrete. The potential increase in load capacity at increased load rate for some failure modes should not be relied upon in seismic design situations.

The influence of (seismic) load cycling on anchor behaviour depends on the loading direction, failure mode and product type.

- Under **tension load cycling**, the differences between seismic and static behaviour are limited to the load range immediately prior to anchor failure (load more than 75% of the ultimate capacity), therefore tension load cycling does not play a critical role in the design capacity.

The load-displacement response under tension load cycling for all possible failure modes typically stays within the envelope for static (monotonic) loading, therefore cycling in the pre-peak region (low level load cycling without anchor failure), may lead to an increase in the stiffness of the anchor response subsequent to cycling. However, the ultimate load and displacement capacity subsequent to tension cycling remain largely unaffected.

- Under **shear load cycling**, anchors located far from edges of the concrete member in which they are anchored typically fail by steel failure in the anchor shaft. The anchor cross-section at the point of shearing, the concrete strength and potential confinement of the concrete in the immediate vicinity of the anchor strongly affect the shear behaviour. In general, higher shear load capacities are achieved by providing more steel across the shearing plane, i.e., anchors with a high shaft diameter to embedment depth ratio. However, under reversed shear loads low-cycle fatigue of the anchor can occur at loads well-below the static shear capacity. The reduction is strongly product dependent. For this reason, seismic shear capacities should always be taken from the approval test data derived from recognized simulated seismic tests.

For anchors located close to an edge or very shallow anchors concrete failure under shear load may occur, concrete edge breakout or concrete pryout, respectively. Few data are available for simulated seismic shear loading under these conditions, how-

ever, it is assumed that the behaviour will be comparable to concrete cone failure in tension, i.e., shear load cycling does not play a critical role in determining the design capacity.

The increased uncertainty and reduced probability of occurrence of earthquake actions compared to nonseismic actions is accounted for in the load combinations and safety factors used in seismic design codes. It is essential, however, to make sure that the design provisions used to establish the seismic loading on an anchorage use a methodology (safety concept) that is compatible with the resistances obtained from a seismic product approval.

Interaction between anchorage and structure

When designing anchorages, it is important to remember that they should not be regarded as isolated systems taking up seismic forces, but rather, they must be incorporated in the overall design. In some applications, such as very large mechanical equipment, there may be dynamic interactions between the structure and the attached component. Furthermore, considering the design beyond the anchorage level may allow more options to accommodate displacements or to incorporate load limiting yielding mechanisms.

Approval for seismic use

In the United States a complete methodology for seismic design of anchors is available. Design provisions are provided by the American Concrete Institute (ACI) in ACI 318 Appendix D (2008) and resistances are available from current Evaluation Service Reports (ESRs) issued by the International Code Council – Evaluation Service, Inc. (ICC-ES). The International Building Code (IBC) has adopted these documents.

To achieve Uniform Building Code (UBC) and IBC compliance, Hilti mechanical anchors are tested according to the ICC-ES AC193. Adhesive anchors are tested to AC308 and. The UBC has provisions for both strength design (comparable to load resistance comparison on design level according to EC) and allowable stress design (comparison of load and resistance on working load level). For these two different design methods different load combinations with different safety factors are provided for the design engineer to take into consideration.

There are also a large number of Hilti anchors that have been tested according to other procedures: ICBO, CAN/CSA, KEPCO, ENEL, Bechtel, Sweep1, Sweep2. The test results are valid only under the assumptions for the particular test procedures.

3.3 Anchor design for seismic actions

External load

The exact external load on an anchor during an earthquake depends on a multitude of parameters and can in general only be calculated using powerful tools such as response spectra dynamic analysis.

For the attachment of components to building structures often simplified procedures as the two given below are sufficient to estimate the seismic anchor forces:

a) plastification of attachment

Where ductile fixtures are concerned, i.e. those which can be deformed in the plastic range, such as base plates, columns or brackets, the fastening may be designed in such a way that it is capable of taking up those forces which are transferred when

plastic deformation of the building component takes place. It is assumed in this case that that the transferred force and the moment during plastic deformation remain constant

The moment, M , acting on a fastening is equated to the plastic moment, M_{plast} , where the plastic moment results from the moment of resistance and the yield strength of the fixture. Then, the forces existing with this moment, F_{plast} , are determined from the plastic moment, M_{plast} . The plastic deformation limits, so to speak, the max. possible force.

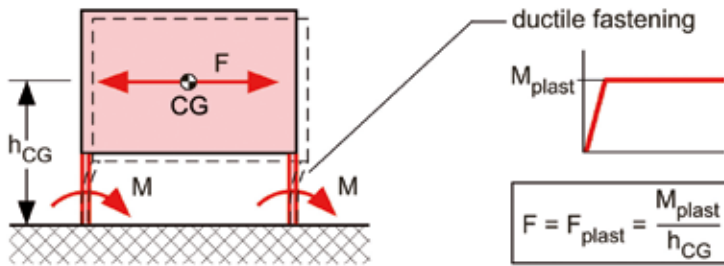

b) equivalent static analysis with amplification factors

The equivalent static analysis is the method suitable for designing fastenings for fixtures whose natural frequencies are considerably higher than the frequency of the ground oscillation (excitation frequency). Usually, this applies to fixtures (building components) with a fundamental frequency $f_0 > 15$ Hz. Examples of such fixtures are comparatively compact pieces of equipment which have stiff structures, like air conditioners.

During an earthquake and if the fixture is stiff, it is subjected to an acceleration identical to that of the building or floor on which it is fastened. The equivalent force, acting at the fixture center of gravity (CG) and relevant for designing the fixture fastening, is equal to the mass inertia force, F , used when calculating the building floor acceleration, a_{floor} .

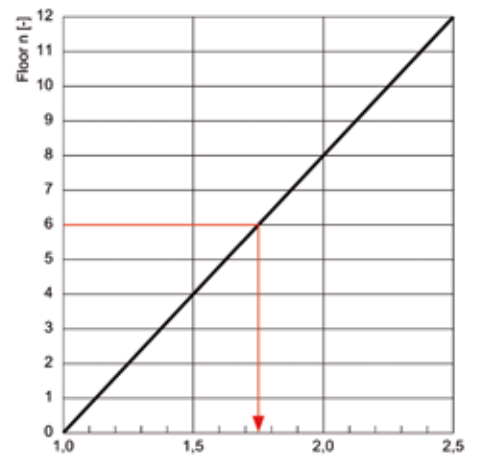
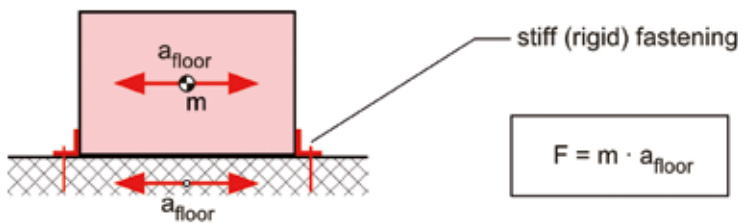

Table 1: Amplification factor for building height afloor

This simplified procedure cannot be applied to buildings with more than twelve floors. A dynamic analysis of the load-bearing structure then becomes necessary.

Where fixtures are concerned which are not stiff, such as equipment installed on spring damping units or building components which have a comparatively low level of stiffness, the incitation by seismic actions can amplify the equipment acceleration, a_{equip} , to the extent that it lies significantly above the floor acceleration, a_{floor} . Several sources in literature give an amplification factor $A_{equip} = 2.0$ when the ratio of the natural period of the fixture (incl. the fastening), T_{equip} , to the period of the building or floor, T_{floor} , satisfies the following condition.

$$0.6 < T_{equip} / T_{floor} < 1.4$$

Taking this rule as the basis and the floor natural frequency in a standard case $f_{o, \text{floor}} = 10 \text{ Hz}$, it is assumed as a simplification that amplification is relevant for less stiff fixtures and for fastenings with a natural frequency $f_{o, \text{equip}} < 15 \text{ Hz}$.

- Stiff fixtures $f_{o, \text{equip}} = 15 \text{ Hz}$:
 $A_{\text{equip}} = 1.0$
- Elastic fixtures $f_{o, \text{equip}} < 15 \text{ Hz}$:
 $A_{\text{equip}} = 2.0$

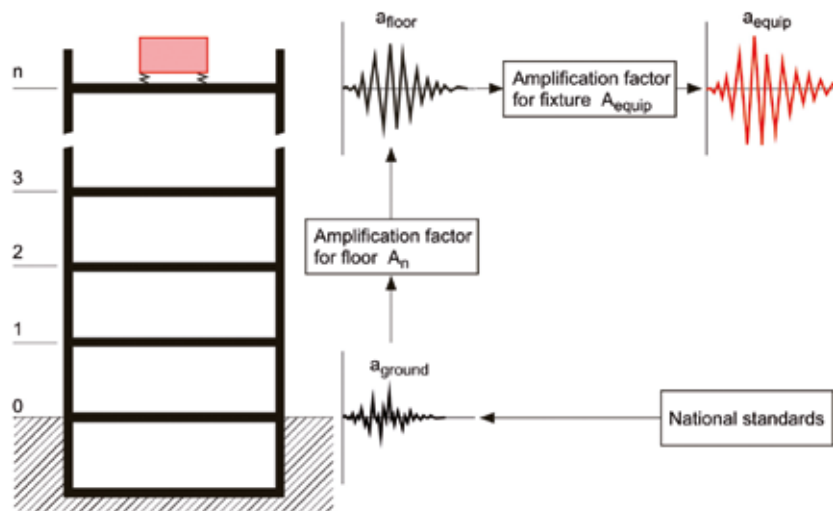

Simplified estimation of anchor loads with amplification factors

Concrete cracking

In general, reinforced concrete structures will undergo cracking during an earthquake. Since anchors disrupt the stress field in the anchorage member, they may act as crack attractors or initiators. For these reasons, it should be assumed that an anchor will be situated in a crack and the design factors for cracked concrete should be used in seismic situations. Furthermore, post-installed anchors used for seismic applications should be qualified for use in cracked concrete and have seismic resistance values established through recognized simulated seismic tests.

Exception for cast-in-place anchors: For special situations where the design documents demonstrate that no cracking can occur as a result of the earthquake in the region of an anchorage, e.g. in massive foundations or prestressed members where the prestressing will not be overcome during the design earthquake, design factors for uncracked concrete may be used (relevant for cast-in-place anchors only).

Anchor resistance

ICC-ES Evaluation reports give the anchor resistances for the strength design according to ACI 318 appendix D. Anchors qualified for seismic loads according to the above report can be used in strength design according to ACI 318. The procedure is the same as for static loads, except for the following:

- The anchors cannot be used in plastic hinge zones of concrete structures under earthquake forces.
- The pullout strength N_p and steel strength in shear V_{sa} are different from the static values; they are based on the corresponding seismic test defined in AC308.2
- The design strength against concrete related failure modes (cone, combined pullout and concrete cone, splitting, concrete edge, pryout) are reduced by a reduction factor of $\phi_{\text{seismic}} = 0.75$.

- In general the anchors have to be designed in such a way that the steel strength of either the anchor or the attachment is governing.
- If an anchor needs to be designed with a concrete related failure mode governing, its design strength needs to be reduced by an additional factor of 0.4.

3.4 Product information: Seismic

Evaluation Service Reports (ESRs), which allow seismic design, are available (download at www.icc-es.org) for the following products (status September 2010):

Anchors for use in concrete:

HSL-3	ESR-1545	reissued March 1, 2008
HDA	ESR-1546	reissued March 1, 2008
Kwik Bolt TZ	ESR-1917	reissued September 1, 2007
HIT-RE 500-SD	ESR-2322	reissued July 1, 2009
HIT-HY 150 MAX-SD	ESR-3013	issued April 1, 2010

Anchors for use in masonry:

HIT-HY 150-MAX	ESR-1967	reissued January 1, 2008
Kwik Bolt 3	ESR-1385	reissued January 1, 2007

3.5 Design example water tank on roof

3.5.1 Design situation

A water tank is fastened to the concrete roof of a two storey building. The tank is supported on four poles made of tubes with outer diameter 48.2mm and wall thickness 2.6mm → $W = 4050\text{mm}^3$, their height is $h_p = 50\text{cm}$. Four-hole base plates and heavy-duty anchors HSL-3 secure the water tank to the rooftop.

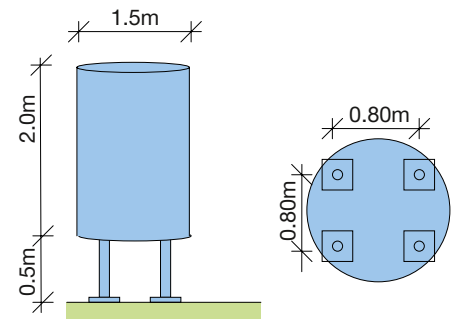

Anchor base plates:	160mm × 160mm
Spacing between anchors:	110mm
Mass of tank:	$m = 4000\text{kg}$
Design seismic acceleration:	$a = 0.35g$

Amplification factor for fixing on 2 nd floor:	$A_n = 1.25$	(table 1, p. 29)
Amplification factor for fixing stiffness:	$A_{equip} = 1.0$	stiff fixing, see p. 30)
Horizontal design load in earthquake:	$F_{h,seismic} = a \cdot A_n \cdot A_{equip} \cdot m = 17.17\text{kN}$	

Yielding moment of leg:	$M_y = f_{yk} \cdot W = 0.95\text{ kNm}$
Horizontal force required on top of legs for M_y :	$F_{h\ell,y} = M_y / (h_p / 2) = 3.80\text{ kN}$
Horizontal force required to yield all four legs:	$F_{h,y} = 4 \cdot F_{h\ell,y} = 15.20\text{ kN}$
Overturning moment on entire tank:	$M_{ot} = F_{h,y} \cdot 1.5\text{ m} = 22.80\text{ kNm}$

$F_{h,y} < F_{h,seismic}$ → attachment will yield under seismic design acceleration

At the time of yielding of the legs, the loads on one leg are:

Vertical: Weight	$G = -40 / 4 = -10.0\text{ kN}$
Tension out of overturning moment:	$T = M_{ot} / 0.80\text{ m} / 2 = 14.3\text{ kN}$
Normal force:	$N = T + G = 4.25\text{ kN}$
Shear :	$V = F_{h\ell,y} = 3.80\text{ kN}$
Moment :	$M = M_y = 0.95\text{ kNm}$

The anchor plate can be designed with Profis Anchor. To design for seismic loads according to ACI 318, the design standard “North American (ICC based)” should be selected when a project is created:

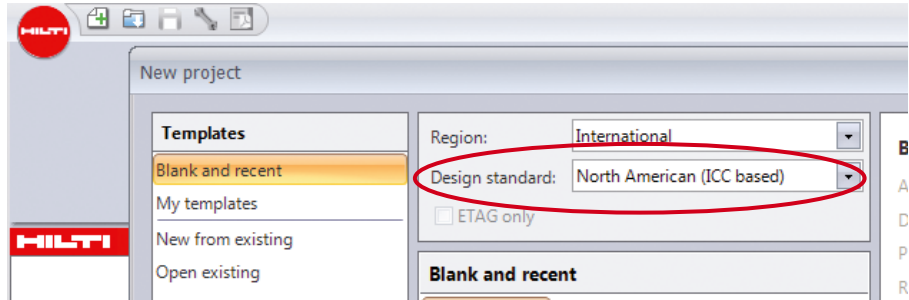

In the definition of the loads, under the loads tab, the loads should be defined as

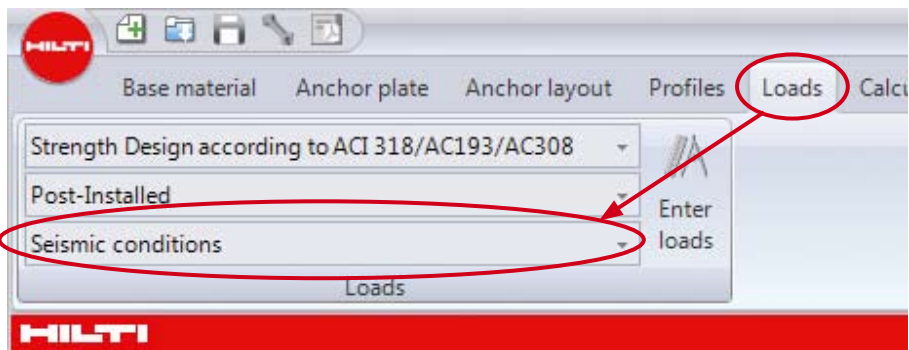

Here are the Profis results for the tensile loads calculated with **Hilti HSL-3, size M8** (shear loads are only minor):

Tension load

Proof	Load $N_{??}$ [kN]	Capacity ϕN_s [kN]	Utilisation β [%] = $N_{??} / \phi N_s$	Status
Steel failure*	5.014	16.544	30	OK
Pull-out failure*	N/A	N/A	N/A	N/A
Concrete cone failure**	10.028	13.832	72	OK

*most unfavourable anchor
 **anchor group (anchors in tension)

Steel failure

$N_{??}$ [kN]	ϕ	c [mm]	$c_{??}$ [mm ²]	c [mm]
52121	32340	N/A	N/A	N/A

Concrete cone failure

$A_{??}$ [mm ²]	$A_{??}$ [mm ²]	c [mm]	$c_{??}$ [mm ²]
52121	32340	N/A	N/A

$e_{??}$ [mm]	$\psi_{??}$	$e_{??}$ [mm]	$\psi_{??}$	$\psi_{??}$	$\psi_{??}$	$k_{??}$
0	1000	0	1000	1000	1000	17000

$N_{??}$ [kN]	ϕ	$\phi_{seismic}$	$\phi N_{??}$ [kN]	$N_{??}$ [kN]
52121	32340	N/A	N/A	32340

The seismic reduction factor $\phi_{\text{seismic}} = 0.75$ has been taken into account in the calculations. The controlling mode of failure is “concrete cone” with utilisation $\beta_N = 90\%$. Nevertheless, as the legs are yielding, “the steel strength of a ductile steel element governs” (ACI 318, D3.3.4, cf. sect 3.3, p. 31 of this manual).

3.5.2 Influence of stiffeners

The legs and anchor plates are equipped with stiffeners, so that the effective bending length of the legs is reduced to $h_{p,ef} = 0.4 \text{ m}$.

Horizontal force required on top of legs to achieve yielding moment:

$$F_{h_{l,y,ef}} = M_y / (h_{p,ef} / 2) = 4.75 \text{ kN}$$

Horizontal force required to yield all four legs:

$$F_{h_{y,ef}} = 4 \cdot F_{h_{l,y,ef}} = 19.0 \text{ kN}$$

$$F_{h_{y,ef}} > F_{h_{l,seismic}}$$

→ seismic design acceleration (load) controls

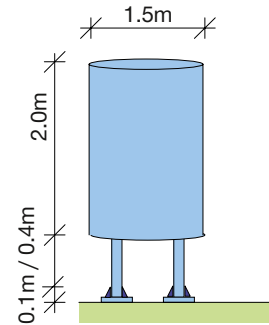

Overtuning moment on entire tank: $M_{ot2} = F_{h,seismic} \cdot 1.5 \text{ m} = 25.8 \text{ kNm}$

At the time of yielding of the legs, the loads on one leg are:

Vertical:	Weight	$G = -40 / 4 = -10.0 \text{ kN}$
	Tension out of overturning moment:	$T = M_{ot} / 0.80 \text{ m} / 2 = 16.1 \text{ kN}$
	Normal force:	$N = T + G = 6.13 \text{ kN}$
Shear :		$V = F_{h_{l,seismic}} / 4 = 4.29 \text{ kN}$
Moment :		$M = V \cdot (h_{p,ef} / 2) = 0.86 \text{ kNm}$

Profis Results for **HSL-3, size M8**:

Tension load

Proof	Load $N_{??}$ [kN]	Capacity ϕN_{ϕ} [kN]	Utilisation β [%] = $N_{??} / \phi N_{\phi}$	Status
Steel failure*	5.147	16.544	31	OK
Pull-out failure*	N/A	N/A	N/A	N/A
Concrete cone failure**	10.295	13.832	74	OK

*most unfavourable anchor
 **anchor group (anchors in tension)

Compared to the previous calculation the utilisation for concrete cone increases only slightly from 72% to 74%. BUT due to the stiffeners, the legs of the tank will not yield in this case. Thus, the brittle failure mode of concrete cone is controlling now.

If a failure mode with controlling ductile steel capacity cannot be guaranteed, ACI 318, D3.3.6 permits the alternative “to take the design strength of the anchors as 0.4 times the design strength determined”. In other words, if the utilisation is below 40%, the design can be accepted even if a brittle failure mode controls. This can be achieved by changing to a larger size anchor.

Profis Results with **HSL-3, size M12**:**Tension load**

Proof	Load $N_{??}$ [kN]	Capacity $\phi N_?$ [kN]	Utilisation β [%] = $N_{??} / \phi N_?$	Status
Steel failure*	5.218	38.022	14	OK
Pull-out failure*	N/A	N/A	N/A	N/A
Concrete cone failure**	10.436	27.203	38	OK

*most unfavourable anchor

**anchor group (anchors in tension)

The diameter of the clearance hole in the base plate for HSL-3 M8 is 14 mm, that required for HSL-3 M12 is 20 mm. If this cannot be adapted any more, a solution is required to achieve ductile failure of the anchor. This can be achieved by using adhesive anchors set relatively deep: With HIT-V threaded rods, diameter M12, the required clearance hole diameter is also 14 mm. With Hilti **HIT-RE 500SD, with HIT-V (5.8), diameter 12 mm, embedment depth 240 mm**:

Tension load

Proof	Load $N_{??}$ [kN]	Capacity $\phi N_?$ [kN]	Utilisation β [%] = $N_{??} / \phi N_?$	Status
Steel failure*	5.076	12.025	42	OK
Pull-out failure*	10.555	27.643	38	OK
Concrete cone failure**	10.555	43.024	25	OK

*most unfavourable anchor

**anchor group (anchors in tension)

Steel failure has the highest utilisation with $\beta_{N,steel} = 42\%$; the brittle failure modes have only $\beta_{N,bond} = 38\%$ and $\beta_{N,cone} = 25\%$. As according to ACI 318 the ductile failure the ductile failure mode controls, this solution is acceptable also with a utilisation higher than 40%.

N.B.: With the given clearance hole size, a solution with HIT-V M12 may be more suitable.

4. Shock

4.1 Shock loads



Shock-like phenomena, i.e. a crashing vehicle, ship or aeroplane and falling rocks, avalanches and explosions, have such characteristics as a very short duration and tremendously high forces which, however, generally only occur as individual peaks. As the probability is slight that such a phenomenon will occur during the life expectancy of the building components concerned, plastic deformation is usually permitted if such an event takes place in order to avoid an uneconomical design. This means that the behaviour of the fastening must be as ductile as possible and that it will be replaced after the phenomenon has occurred.

The engineer responsible for a specific project must work out the magnitude of the action and the permissible deformation (elastic, elastic-plastic) each time.

4.2 Anchors under shock load

Load increase times in the range of milliseconds can be simulated during tests on servo-hydraulic testing equipment. The following main effects can then be observed:

- deformation is greater when the breaking load is reached.
- the energy absorbed by an anchor is also much higher.
- breaking loads are of roughly the same magnitude during static loading and shock-loading tests.

In this respect, more recent investigations show that the base material (cracked or non-cracked concrete), has no direct effect on the load bearing behaviour.

Suitability under shock loading

To date, mechanical anchor systems have been used primarily for applications in civil defence installations. These mechanical anchors have had their suitability proofed when set in cracked concrete. Recently, adhesive systems suitable for use in cracked concrete have been developed, e.g. the HVZ anchor, or the HIT-RE 500-SD adhesive whose suitability for shock loading were also verified. For other shock-like loads, such as those acting on the fastenings of guide rail systems, both mechanical anchors and chemical systems can be considered.

Exceptional loads allow deformations

For the shock design it is very important to define the admissible deformations and the actions that have to be taken after the shock event.

If only elastic deformations are allowed (no permanent deformations) after the shock incident, the static resistances of the anchor are also suitable for shock. This leads often to a non-economic anchor selection. To avoid this, different regulations allow plastic deformations on condition that the anchors are replaced after the shock incident.

4.3 Anchor design for shock loads

In order to obtain the shock approvals, anchors are tested under tensile shock loads of magnitude R_{class} in cracks of 1mm width. These data are given in section 4.4. The allowable shock load is then calculated as

$$R_{adm,shock} = \min(N_{Rd,s}; N_{Rd,c}; N_{Rd,p}; N_{Rd,sp}; R_{class})$$

$N_{Rd,s}$ and $N_{Rd,c}$ are calculated according to the CCD-method (ETAG 001- annex C, Fastening Technology Manual or Profis Anchor); they are depending on the load direction. $N_{Rd,c}$ also takes into account the influence of spacing and edge distance.

R_{class} is the load for which the anchor has been approved based on shock tests in a 1 mm crack with limited displacement. It is valid for all load directions since the tested pure tensile load is the most unfavourable direction for pullout failure.

4.4 Product information: Shock

The following anchor resistances are the approved values from the BZS (Bundesamt für Zivilschutz: Swiss Authority for Civil Defence). This Product information is only valid together with the general Product information given in the Fastening Technology Manual FTM.

The shock design requires the values in the following tables together with the concrete and steel resistance according to the CCD method. The procedure is described in section 4.3 of this manual.

HST-Anchors

Shock approval: BZS D 08-602, valid until: 30.12.2018



Anchor		Permitted Shock Load Rclass kN	Anchor Hole		Tightening Torque T Nm
Size	Type Denomination		∅ mm	Depth mm	
M8	HST/HST-R M8	3.1	8	65	20
M10	HST/HST-R M10	6.1	10	80	45
M12	HST/HST-R M12	8.1	12	95	60
M16	HST/HST-R M16	14	16	115	110
M20	HST/HST-R M20	20	20	140	240
M24	HST/HST-R M24	26	24	170	300

HSC-Anchors

Shock approval: BZS D 06-601, valid until: 31.07.2016



HSC-A/AR

HSC-I/IR

Anchor		Permitted Shock Load Rclass kN	Anchor Hole		Tightening Torque T Nm
Size	Type Denomination		∅ mm	Depth mm	
M6	M6x40 I/IR	5.5	14	46	10
M8	M8x40 A/AR	5.5	14	46	10
	M8x40 I/IR	5.5	16	46	10
	M8x50 A/AR	7.7	14	56	10
M10	M10x40 A/AR	5.5	16	46	20
	M10x50 I/IR	7.7	18	58	20
	M10x60 I/IR	10.2	18	68	30
M12	M12x60 A/AR	10.2	18	68	30
	M12x60 I/IR	10.2	20	68	30

HSL-Anchors

Shock approval: BZS D 08-601, valid until: 30.06.2018



HSL-3

HSL-3-B

HSL-3-G

HSL-3-SH

HSL-3-SK

Anchor		Permitted Shock Load Rclass kN	Anchor Hole		Tightening Torque T Nm
Size	Type Denomination		∅ mm	Depth mm	
M8	HSL-3/-B/-G/-SH/-SK	8.1	12	80	25
M10	HSL-3/-B/-G/-SH/-SK	11	15	90	50
M12	HSL-3/-B/-G/-SH/-SK	17	18	105	80
M16	HSL-3/-B/-G	26	24	125	120
M20	HSL-3/-B/-G	32	28	155	200
M24	HSL-3/-B	38	32	180	250

HDA-Anchor

Shock approval: BZS D 09-601, valid until: 31.10.2019



HDA

Anchor		Permitted Shock Load Rclass kN	Anchor Hole		Tightening Torque T Nm
Size	Type Denomination		∅ mm	Depth mm	
M10	HDA-T(R) M10/HDA-P(R) M10	17	20	107	50
M12	HDA-T(R) M12/HDA-P(R) M12	23	22	133	80
M16	HDA-T(R) M16/HDA-P(R) M16	35	30	203	120
M20	HDA-T M20/HDA-P M20	50	37	266	300

HVZ-Anchor

Shock approval: BZS D 09-602, valid until: 31.10.2019



HVZ

Anchor		Permitted Shock Load Rclass kN	Anchor Hole		Tightening Torque T Nm
Size	Type Denomination		∅ mm	Depth mm	
M10	HVZ(R) M10x75	8.1	10	90	40
M12	HVZ(R) M12x95	11	12	110	50
M16	HVZ(R) M16x105	17	18	125	90
	HVZ(R) M16x125	17	18	145	90
M20	HVZ (R) M20x170	26	25	195	150

HIT-RE 500-SD

Shock approval: BZS D 09-604, valid until: 31.10.2019



With HIT-V 5.8 / HIT-V 8.8 / HIT-V-R / HIT-V-HCR rod ad setting depth hef,typ

Anchor		Permitted Shock Load Rclass kN	Anchor Hole		Tightening Torque T Nm
Size	Type Denomination		∅ mm	Depth mm	
M8	HIT-V M8 with RE 500-SD	6.1	10	80	10
M10	HIT-V M10 with RE 500-SD	8.1	12	90	20
M12	HIT-V M12 with RE 500-SD	11	14	110	40
M16	HIT-V M16 with RE 500-SD	17	18	125	80
M20	HIT-V M20 with RE 500-SD	26	24	170	150
M24	HIT-V M24 with RE 500-SD	32	28	210	200
M27	HIT-V M27 with RE 500-SD	35	30	240	270
M30	HIT-V M30 with RE 500-SD	41	35	270	300

With HIS-(R)N

Anchor		Permitted Shock Load Rclass kN	Anchor Hole		Tightening Torque T Nm
Size	Type Denomination		∅ mm	Depth mm	
M8	HIS-(R)N M8 with RE 500-SD	11	14	90	10
M10	HIS-(R)N M10 with RE 500-SD	17	18	110	20
M12	HIS-(R)N M12 with RE 500-SD	23	22	125	40
M16	HIS-(R)N M16 with RE 500-SD	32	28	170	80
M20	HIS-(R)N M30 with RE 500-SD	38	32	205	150

4.5 Design examples: Shock

4.5.1 Elastic collision: Fixing of safety rope

The fixing of a safety rope is to be defined. The test to approve such fixings is defined in the code BS_EN 795. Parameters are as follows:

Given:

concrete strength class:	C40/50, cracked
applied mass:	$m = 100 \text{ kg}$
height of fall:	$h = 2.5 \text{ meters}$
length of rope:	$\ell = 2.0 \text{ meters}$

When the load is increased from 50kN to 150kg, the elongation of the rope increases by $\epsilon_{100} = 1.0\%$.

Which HSL-3 anchor is required?

$$\text{spring elasticity of rope: } c = \frac{100 \text{ kg} \cdot g}{\epsilon_{100} \cdot \ell} = 49'050 \text{ N/m}$$

$$\text{Energy of fall height: } E_{pot} = m \cdot g \cdot h$$

$$\text{energy in rope at end of fall: } E_{spring} = \int_0^{\Delta \ell_d} (c \cdot s) ds = \frac{c \cdot \Delta \ell_d^2}{2}$$

$$E_{pot} = E_{spring} \rightarrow \Delta \ell_d = \sqrt{\frac{2 \cdot m \cdot g \cdot h}{c}} = 0.316 \text{ m}$$

$$\text{static length extension: } \Delta \ell_s = \ell \cdot \epsilon_{100} = 2.0 \cdot 0.01 = 0,020 \text{ m}$$

$$\text{force in rope: } F_{dyn} = c \cdot (\ell_d + \ell_s) = 16,5 \text{ kN}$$

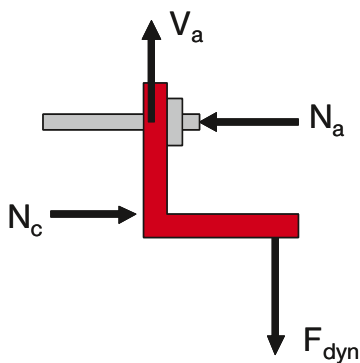

The shock load F_{dyn} is taken up by the anchor shear force V_a . F_{dyn} and V_a create a moment which will be balanced by concrete compression N_c at the lower end of the angle and anchor tension N_a . Assume that $|N_a| = |V_a|$.



1st Approach:

only elastic deformations of anchors admissible: → design with static approach
 use only anchors suitable for cracked concrete

Acting Force: $\gamma_G \cdot F_{dyn} = 1.35 \cdot 16.5 \text{ kN} =$ $N_{Sd} = V_{Sd} = 22.3 \text{ kN}$
 HSL-3 M16: $f_B = 1.41 \rightarrow N_{Rd,c} = 1.41 \cdot 24.0 = 33.8 \text{ kN}; N_{Rd,s} = 83.7 \text{ kN} \rightarrow N_{Rd} = 33.8 \text{ kN}$
 $V_{Rd,cp} = 1.41 \cdot 34.3 = 67.7 \text{ kN}; V_{Rd,s} = 80.9 \text{ kN} \rightarrow V_{Rd} = 67.7 \text{ kN}$
 $(N_{Sd}/N_{Rd})^{1.5} + (V_{Sd}/V_{Rd})^{1.5} = 0.72 < 1$ ✓

2nd Approach:

plastic deformations admissible: → use shock design according to BZS approval

Acting Force: $F_{dyn} =$ $N_{dyn} = V_{dyn} = 16.5 \text{ kN}$
 HSL-3 M12: $f_B = 1.41 \rightarrow N_{Rd,c} = 1.41 \cdot 17.2 = 24.3 \text{ kN}; N_{Rd,s} = 44.9 \text{ kN} \rightarrow N_{Rd} = 24.3 \text{ kN}$
 $V_{Rd,cp} = 1.41 \cdot 34.3 = 48.4 \text{ kN}; V_{Rd,s} = 57.4 \text{ kN} \rightarrow V_{Rd} = 48.4 \text{ kN}$
 $(N_{Sd}/N_{Rd})^{1.5} + (V_{Sd}/V_{Rd})^{1.5} = 0.76 < 1$ ✓
 Resulting shock load: $\vec{N}_{dyn} + \vec{N}_{dyn} = 16.5 \cdot \sqrt{2} =$ $R_{Sh} = 23.3 \text{ kN}$
 Admissible shock load: $R_{sh,adm} = f_B \cdot R_{class} = 1.41 \cdot 17 = 24.0 \text{ kN} < R_{Sh}$ ✓

4.5.2 Simplified design acc. to regulations of BZS*

*BZS: Bundesamt für Zivilschutz (Swiss Federal Authority for Civil Defence)

Assumptions:

The shock loads are substituted by static forces with $F = DLF \cdot m \cdot a_{max}$

F: static Force

DLF: dynamic load factor (recommendation $F = 1.25$)

m: mass of equipment

a_{max} : maximum acceleration (recommendation $a_{max} = 125 \text{ m/s}^2$)

Facts in addition to all other forces in the centre of gravity in the most critical direction. This means the shock design has to be done in the direction of three orthogonal axes. The equipment is anchored in cracked concrete C20/25.

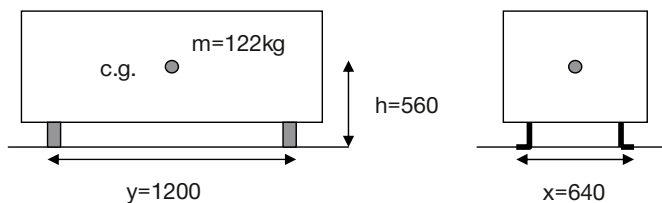

$$F = 1.25 \cdot 122 \text{ kg} \cdot 125 \frac{\text{m}}{\text{s}^2} = 19'063 \text{ N}$$

a) vertical action

$$T = \frac{F}{4} = 4'760 \text{ N}$$

HSC-I M10x60: $N_{Rd,c}^0 = 11.1 \text{ kN}, N_{Rd,s} = 20.2 \text{ kN}$
 $R_{class} = 10.2 \text{ kN}$

spacing and edge distances large, no influence

$$R_{adm,shock} = \min(N_{Rd,s}, N_{Rd,c}, R_{class}) = 10.2 \text{ kN} > T \rightarrow \text{ok}$$

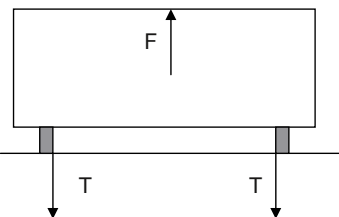

b) longitudinal horizontal action

assumption: $V = \frac{F}{4} = 4'760N$

$$T = \frac{F \cdot h}{2 \cdot y} = \frac{19'036N \cdot 560mm}{2 \cdot 1'200mm} = 4'450N$$

$$C = \sqrt{V^2 + T^2} = \sqrt{4'760^2 + 4'450^2} = 6'520N$$

$\text{tg}\alpha = V/T = 1.07 \rightarrow \alpha = 46.9^\circ$

HSC-I M10x60: $V_{Rd,s} = 12.2 \text{ kN}$

$$F_{Rd} = \left[\left(\frac{\cos \alpha}{N_{Rd,c}} \right)^{1.5} + \left(\frac{\cos \alpha}{V_{Rd,s}} \right)^{1.5} \right]^{-2/3} = 10.4kN$$

$R_{adm,shock} = \min(F_{Rd}, R_{class}) = 10.2 \text{ kN} > C \rightarrow \text{ok}$

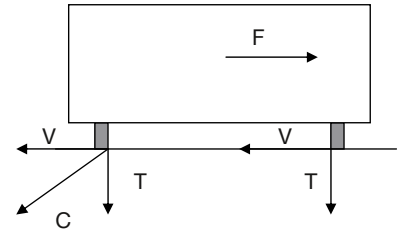

c) lateral horizontal action

assumption: $V = \frac{F}{4} = 4'760N$

$$T = \frac{F \cdot h}{2 \cdot x} = \frac{19'036N \cdot 560mm}{2 \cdot 640mm} = 8'340N$$

$$C = \sqrt{V^2 + T^2} = \sqrt{4'760^2 + 8'340^2} = 9'600N$$

$\text{tg}\alpha = V/T = 0.571 \rightarrow \alpha = 29.7^\circ$

HSC-I M10x60: $V_{Rd,s} = 12.2 \text{ kN}$

$$F_{Rd} = \left[\left(\frac{\cos \alpha}{N_{Rd,c}} \right)^{1.5} + \left(\frac{\cos \alpha}{V_{Rd,s}} \right)^{1.5} \right]^{-2/3} = 10.3kN$$

$R_{adm,shock} = \min(F_{Rd}, R_{class}) = 10.2 \text{ kN} > C \rightarrow \text{ok}$

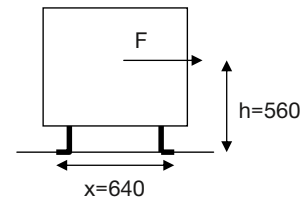

References/literature

Fastening Technology Manual	Issue 2009, Hilti AG, Schaan
J. Kunz	Innovatives Konzept Dübel 2000
J. Kunz, H. Gassner,	dynamisches Bemessungskonzept, 13.12.95, Hilti AG
E. Wisser	Dynamisch belastete Befestigungen in Betonuntergründen, SI+A, Nr.9/1999
K. Block	Dübelbefestigungen unter ermüdungsrelevanten Einwirkungen. Habilitationsschrift, Universität Dortmund, 2001.
Eurocode 1	Grundlagen der Tragwerksplanung und Einwirkungen auf Tragwerke, ENV 1991
Eurocode 2	Planung von Stahlbeton- und Spannbetontragwerken, ENV 1992
Eurocode 3	Bemessung und Konstruktion von Stahlbauten, ENV 1993
Eurocode 8	Seismische Einwirkungen und allgemeine Anforderungen an Bauwerke, ENV 1998
ACI 318-08	Building Code Requirements for Structural Concrete. Appendix D – Anchoring to Concrete. Farmington Hills, MI, 2008
EOTA (European Organization for Technical Approvals)	ETAG 001: Guideline for European Technical Approval of Metal Anchors for Use in Concrete:
W. Fuchs, R. Eligehausen, J.E. Breen	Annex C – Design Methods for Anchorages. Brussels, 2006.
R. Eligehausen, R. Mallée, J. Silva	TR029 – TR 029 Design of Bonded Anchors. Brussels, 2007.
D. Schuler	Concrete Capacity Design Approach for Fastenings to Concrete, ACI Structural Journal, January – February 1995
TW Schock 1995	Anchorage in Concrete Construction. Wiley-VCH, 2006.
Hoehler	Prüfung und Zulassung von Dübelssystemen. Bericht BBS-7531/4. Bundesamt für Bevölkerungsschutz, Bern, 2006.
Test Reports	Technische Weisung für die Schocksicherheit von Einbauteilen in Zivilschutzbauten, Bundesamt für Zivilschutz, 1995
Test Reports	Hoehler, M. S.: Behavior and testing of fastenings to concrete for use in seismic applications. PhD Dissertation, University of Stuttgart, Germany, 2006.
ET Approvals	Hilti AG
BZS Approvals	Institut für Bauforschung, Universität Dortmund
ICC Approvals	www.eota.eu
ET Approvals	https://www.zkdb.vbs.admin.ch/zkdb/
BZS Approvals	www.icc-es.org
ICC Approvals	www.icc-es.org

Appendix A: Dynamic Set

General

For all dynamic actions three main challenges can be identified:

1. For an easy installation the clearance hole always is larger than the external diameter of the anchor. For static loads this is of negligible relevance, but for dynamic loads any relative movement between base plate and anchor can have a negative impact.
2. As most of the anchors are drilled manually they are never 100% vertical. This leads also with pure tensile loads to bending moments in the anchor.
3. With dynamic loads even properly installed anchors have sometimes the problem that the nuts start to loosen during lifetime.

Dynamic Set

To improve this situation Hilti has developed the so called “Dynamic Set”. This includes a special injection washer to fill up the clearance hole with HIT-HY150, a spherical washer to avoid the bending in the anchor, a standard nut and a special locknut to avoid any nut loosening.

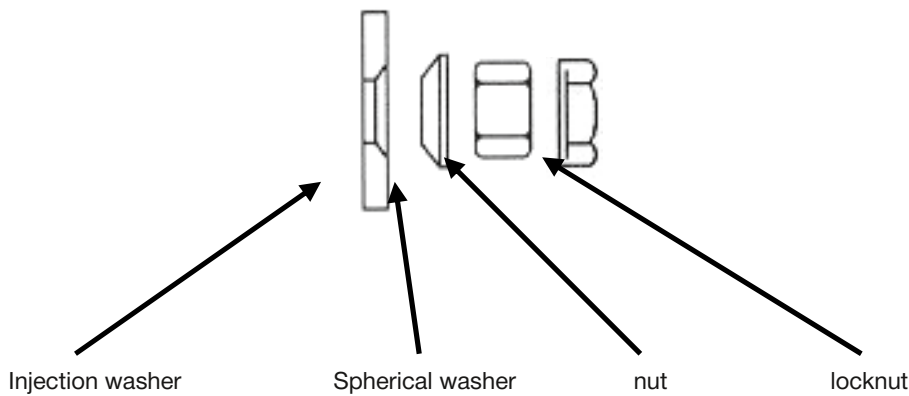

This dynamic set has to be used for all fatigue applications and the load values given in the “PI fatigue” in chapter 4 are only valid in combination with this set. For all other applications the use of this set is not mandatory but it helps to improve the situation especially if shear forces are acting.

Hilti. Outperform. Outlast.

Hilti Corporation | 9494 Schaan | Liechtenstein | P +423-234 2111 | F +423-234 2965 | www.hilti.com