

Centre Scientifique et  
Technique du Bâtiment

84 avenue Jean Jaurès  
CHAMPS-SUR-MARNE  
F-77447 Marne-la-Vallée Cedex 2  
Tél. : (33) 01 64 68 82 82  
Fax : (33) 01 60 05 70 37

## European Technical Assessment

## ETA-20/0539 dated 13/12/2023

*English translation prepared by CSTB - Original version in French language*

### General Part

#### Technical Assessment Body issuing the European Technical Assessment:

Centre Scientifique et Technique du Bâtiment (CSTB)

Trade name:

**Injection system Hilti HIT-RE 500 V4 for rebar connection**

Product family:

Post-installed reinforcing bar (Rebar) connections with improved bond-splitting behaviour under static loading and seismic action for a working life of 100 years

Manufacturer:

Hilti Corporation  
Feldkircherstrasse 100  
FL-9494 Schaan  
Principality of Liechtenstein

Manufacturing plants:

Hilti plants

This European Technical  
Assessment contains:

23 pages including 20 pages of annexes which form an integral part of this assessment

This European Technical  
Assessment is issued in  
accordance with Regulation (EU)  
No 305/2011, on the basis of:

EAD 332402-00-0601-v02

This Assessment replaces:

ETA-20/0539 dated 05/07/2022

*The European Technical Assessment is issued by the Technical Assessment Body in its official language. Translations of this European Technical Assessment in other languages shall fully correspond to the original issued document and shall be identified as such. Communication of this European Technical Assessment, including transmission by electronic means, shall be in full. However, partial reproduction may only be made with the written consent of the issuing Technical Assessment Body. Any partial reproduction shall be identified as such. This European Technical Assessment may be withdrawn by the issuing Technical Assessment Body, in particular pursuant to information by the Commission in accordance with Article 25(3) of Regulation (EU) No 305/2011.*

## Specific Part

### 1 Technical description of the product

The Hilti HIT-RE 500 V4 is used for the connection, by anchoring or overlap joint, of reinforcing bars (rebars) in existing structures made of ordinary non-carbonated concrete C20/25 to C50/60. The design of the post-installed rebar connections is done in accordance with EOTA Technical Report TR 069.

Covered are rebar anchoring systems consisting of Hilti HIT-RE 500 V4 bonding material and an embedded straight deformed reinforcing bar diameter,  $d$ , from 8 to 40 mm with properties according to Annex C of EN 1992-1-1 and EN 10080. The classes B and C of the rebar are recommended. The illustration and the description of the product are given in Annexes A.

### 2 Specification of the intended use

The performances given in Section 3 are only valid if the anchor is used in compliance with the specifications and conditions given in Annexes B.

The provisions made in this European technical assessment are based on an assumed working life of the anchor of 100 years. The indications given on the working life cannot be interpreted as a guarantee given by the producer, but are to be regarded only as a means for choosing the right products in relation to the expected economically reasonable working life of the works.

### 3 Performance of the product

#### 3.1 Mechanical resistance and stability (BWR 1)

| Essential characteristic  | Performance         |
|---|---------------------|
| Resistance to concrete cone failure   | See Annex C1        |
| Robustness  | See Annex C1        |
| Resistance to combined pull-out and concrete cone failure in uncracked concrete       | See Annex C2 and C3 |
| Resistance to bond splitting failure  | See Annex C4        |
| Influence of cracked concrete on resistance to combined pull-out and concrete failure | See Annex C4        |
| Resistance to bond-splitting failure under cyclic loading                             | See Annex C5        |
| Influence of increased crack width on resistance to pull-out failure                  | See Annex C5        |
| Resistance to pull-out failure in uncracked concrete under cyclic loading             | See Annex C5        |

#### 3.2 Safety in case of fire (BWR 2)

| Essential characteristic | Performance                                 |
|--------------------------|---|
| Reaction to fire         | Anchorage satisfy requirements for Class A1 |

#### 3.3 Hygiene, health and the environment (BWR 3)

Regarding dangerous substances contained in this European technical approval, there may be requirements applicable to the products falling within its scope (e.g. transposed European legislation and national laws, regulations and administrative provisions).

### 3.4 Safety in use (BWR 4)

For Basic requirement Safety in use the same criteria are valid as for Basic Requirement Mechanical resistance and stability.

### 3.5 Protection against noise (BWR 5)

Not relevant.

### 3.6 Energy economy and heat retention (BWR 6)

Not relevant.

### 3.7 Sustainable use of natural resources (BWR 7)

For the sustainable use of natural resources no performance was determined for this product.

### 3.8 General aspects relating to fitness for use

Durability and Serviceability are only ensured if the specifications of intended use according to Annex B1 are kept.

## 4 Assessment and verification of constancy of performance (AVCP)

According to the Decision 96/582/EC of the European Commission<sup>1</sup>, as amended, the system of assessment and verification of constancy of performance (see Annex V to Regulation (EU) No 305/2011) given in the following table apply.

| Product                           | Intended use   | Level or class | System |
|-----------------------------------|--|----------------|--------|
| Metal anchors for use in concrete | For fixing and/or supporting to concrete, structural elements (which contributes to the stability of the works) or heavy units | —              | 1      |

## 5 Technical details necessary for the implementation of the AVCP system

Technical details necessary for the implementation of the Assessment and verification of constancy of performance (AVCP) system are laid down in the control plan deposited at Centre Scientifique et Technique du Bâtiment.

The manufacturer shall, on the basis of a contract, involve a notified body approved in the field of anchors for issuing the certificate of conformity CE based on the control plan.

### The original French version is signed by

Anca Cronopol  
Head of the division

---

<sup>1</sup> Official Journal of the European Communities L 254 of 08.10.1996

**Product description: Injection mortar and steel elements**

**Injection mortar Hilti HIT-RE 500 V4:** epoxy system with aggregate

330 ml, 500 ml and 1400 ml

Marking:  
 HILTI HIT  
 Product name  
 Production time and line  
 Expiry date mm/yyyy



Product name: "Hilti HIT-RE 500 V4"

**Static mixer Hilti HIT-RE-M**



**Steel elements**

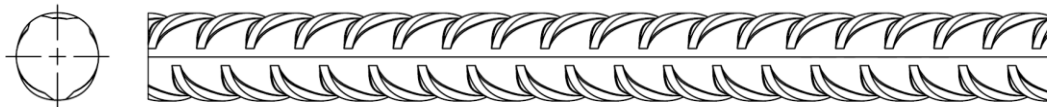

**Reinforcing bar (rebar):**  $\phi$  8 to  $\phi$  40

- Materials and mechanical properties according to Table A1.
- Minimum value of related rib area  $f_R$  according to EN 1992-1-1.
- Rib height of the bar  $h_{rib}$  shall be in the range:  
 $0,05 \cdot \phi \leq h_{rib} \leq 0,07 \cdot \phi$
- The maximum outer rebar diameter over the ribs shall be:  
 $\phi + 2 \cdot 0,07 \cdot \phi = 1,14 \cdot \phi$   
 ( $\phi$ : nominal diameter of the bar;  $h_{rib}$ : rib height of the bar)

**Table A1: Materials**

| Designation                      | Material   |
|----------------------------------|--|
| <b>Reinforcing bars (rebars)</b> |  |
| Rebar<br>EN 1992-1-1             | Bars and de-coiled rods class B or C<br>with $f_{yk}$ and $k$ according to NDP or NCL of EN 1992-1-1<br>$f_{uk} = f_{tk} = k \cdot f_{yk}$ |

**Injection system Hilti HIT-RE 500 V4**

**Product description**

Injection mortar / Static mixer / Steel elements / Materials

**Annex A1**

## Specifications of intended use

### Anchorage subject to:

- Static and quasi-static loading (all drilling techniques).
- Seismic action (hammer drilling and hammer drilling with Hilti hollow drill bit TE-CD, TE-YD only).

### Base material:

- Compacted reinforced or unreinforced normal weight concrete without fibres according to EN 206:2013+A1:2016.
- Strength classes C20/25 to C50/60 according to EN 206:2013+A1:2016.
- Maximum chloride content of 0,40 % (CL 0.40) related to the cement content according to EN 206:2013+A1:2016.
- Non-carbonated concrete.

Note: In case of a carbonated surface of the existing concrete structure the carbonated layer shall be removed in the area of the post-installed rebar connection with a diameter of  $\phi + 60$  mm prior to the installation of the new rebar. The depth of concrete to be removed shall correspond to at least the minimum concrete cover in accordance with EN 1992-1-1. The foregoing may be neglected if building components are new and not carbonated and if building components are in dry conditions.

### Temperature in the base material:

- **at installation**

-5 °C to +40 °C

- **in-service**

Temperature range I: -40 °C to +40 °C

(max. long term temperature +24 °C and max. short term temperature +40 °C)

Temperature range II: -40 °C to +55 °C

(max. long term temperature +43 °C and max. short term temperature +55 °C)

Temperature range III: -40 °C to +75 °C

(max. long term temperature +55 °C and max. short term temperature +75 °C)

### Design:

- Anchorages are designed under the responsibility of an engineer experienced in anchorages and concrete work.
- Verifiable calculation notes and drawings are prepared taking account of the forces to be transmitted.
- Design under static and quasi static loading and seismic action in accordance with EOTA Technical Report TR 069.
- The actual position of the reinforcement in the existing structure shall be determined on the basis of the construction documentation and taken into account when designing.

### Installation:

- Use category:
  - dry or wet concrete (not in water-filled drill holes): for all drilling techniques,
  - water-filled drill holes: for hammer drilling only, rebar diameter  $\phi$  8 to  $\phi$  32 only.
- Drilling technique:
  - hammer drilling,
  - hammer drilling with Hilti hollow drill bit TE-CD, TE-YD,
  - diamond coring,
  - diamond coring with roughening with Hilti Roughening tool TE-YRT.
- Overhead installation is admissible.
- Rebar installation carried out by appropriately qualified personnel and under the supervision of the person responsible for technical matters of the site.
- Check the position of the existing rebars (if the position of existing rebars is not known, it shall be determined using a rebar detector suitable for this purpose as well as on the basis of the construction documentation and then marked on the building component for the overlap joint).

Injection system Hilti HIT-RE 500 V4

Annex B1

Intended use  
Specifications

**Table B1: Minimum concrete cover  $c_{min}^{1)}$  of the post-installed rebar depending on drilling method and drilling tolerance<sup>2)</sup>**

| Drilling method  | Rebar diameter [mm] | Minimum concrete cover $c_{min}^{1)}$ [mm] |   |
|--|---------------------|--|---|
|  |                     | Without drilling aid                       | With drilling aid                       |
| Hammer drilling and hammer drilling with Hilti hollow drill bit TE-CD, TE-YD | $\phi < 25$         | $30 + 0,06 \cdot l_b \geq 2 \cdot \phi$    | $30 + 0,02 \cdot l_b \geq 2 \cdot \phi$ |
|  | $\phi \geq 25$      | $40 + 0,06 \cdot l_b \geq 2 \cdot \phi$    | $40 + 0,02 \cdot l_b \geq 2 \cdot \phi$ |
| Diamond coring   | $\phi < 25$         | Drill stand works like a drilling aid      | $30 + 0,02 \cdot l_b \geq 2 \cdot \phi$ |
|  | $\phi \geq 25$      |  | $40 + 0,02 \cdot l_b \geq 2 \cdot \phi$ |
| Diamond coring with roughening with Hilti Roughening tool TE-YRT             | $\phi < 25$         | $30 + 0,06 \cdot l_b \geq 2 \cdot \phi$    | $30 + 0,02 \cdot l_b \geq 2 \cdot \phi$ |
|  | $\phi \geq 25$      | $40 + 0,06 \cdot l_b \geq 2 \cdot \phi$    | $40 + 0,02 \cdot l_b \geq 2 \cdot \phi$ |

<sup>1)</sup> Comments: The minimum concrete cover acc. EN 1992-1-1.

<sup>2)</sup> Minimum clear spacing is  $a = \max(40 \text{ mm}; 4 \cdot \phi)$ .

**Table B2: Maximum embedment length  $l_{b,max}$  depending on post-installed rebar diameter and dispenser**

| Element<br>Rebar | Dispensers       |                  |                  |
|------------------|------------------|------------------|------------------|
|                  | HDM 330, HDM 500 | HDE 500          | HIT-P8000D       |
| Size             | $l_{b,max}$ [mm] | $l_{b,max}$ [mm] | $l_{b,max}$ [mm] |
| $\phi 8$         | 1000             | 1000             | -                |
| $\phi 10$        |                  | 1000             | -                |
| $\phi 12$        |                  | 1200             | 1200             |
| $\phi 13$        |                  | 1300             | 1300             |
| $\phi 14$        |                  | 1400             | 1400             |
| $\phi 16$        |                  | 1600             | 1600             |
| $\phi 18$        |                  | 700              | 1800             |
| $\phi 20$        | 600              | 2000             | 2000             |
| $\phi 22$        | 500              | 1800             | 2200             |
| $\phi 24$        | 300              | 1300             | 2400             |
| $\phi 25$        | 300              | 1500             | 2500             |
| $\phi 28$        | 300              | 1000             | 2800             |
| $\phi 30$        | -                | 1000             | 3000             |
| $\phi 32$        |                  | 700              | 3200             |
| $\phi 36$        |                  | 600              |                  |
| $\phi 40$        |                  | 400              |                  |

Injection system Hilti HIT-RE 500 V4

Annex B2

Intended use

Minimum concrete cover / Maximum embedment length

**Table B3: Working time and curing time<sup>1) 2)</sup>**

| Temperature in the base material T | Maximum working time $t_{work}$ | Initial curing time $t_{cure,ini}$ | Minimum curing time $t_{cure}$ |
|------------------------------------|---------------------------------|------------------------------------|--------------------------------|
| -5 °C to -1 °C                     | 2 hours                         | 48 hours                           | 168 hours                      |
| 0 °C to 4 °C                       | 2 hours                         | 24 hours                           | 48 hours                       |
| 5 °C to 9 °C                       | 2 hours                         | 16 hours                           | 24 hours                       |
| 10 °C to 14 °C                     | 1,5 hours                       | 12 hours                           | 16 hours                       |
| 15 °C to 19 °C                     | 1 hour                          | 8 hours                            | 16 hours                       |
| 20 °C to 24 °C                     | 30 min                          | 4 hours                            | 7 hours                        |
| 25 °C to 29 °C                     | 20 min                          | 3,5 hours                          | 6 hours                        |
| 30 °C to 34 °C                     | 15 min                          | 3 hours                            | 5 hours                        |
| 35 °C to 39 °C                     | 12 min                          | 2 hours                            | 4,5 hours                      |
| 40 °C                              | 10 min                          | 2 hours                            | 4 hours                        |

<sup>1)</sup> The curing time data are valid for dry base material only. In wet base material the curing times must be doubled.







<sup>2)</sup> The minimum temperature of the foil pack is +5° C.

**Injection system Hilti HIT-RE 500 V4**

**Intended use**  
 Working time and curing time

**Annex B3**

**Table B4: Parameters of drilling, cleaning and setting tools, hammer drilling**

| Element   | Drill and clean   |   |   |   | Installation  |   |                                |
|---|---|---|---|---|---|---|--------------------------------|
| Rebar   | Hammer drilling   | Brush<br>HIT-RB   | Air nozzle<br>HIT-DL  | Extension for air<br>nozzle   | Piston plug<br>HIT-SZ   | Extension<br>for piston<br>plug   | Maximum<br>embedment<br>length |
|  |  |  |  |  |  |  <sup>1)</sup> | -                              |
| size  | d <sub>0</sub> [mm]   | size  | size  | [-]   | size  | [-]   | l <sub>b,max</sub> [mm]        |
| φ 8   | 10  | 10  | 10  | HIT-DL 10/0,8<br>or<br>HIT-DL V10/1   | -   | HIT-VL<br>9/1,0   | 250                            |
|   | 12  | 12  | 12  |   | 12  |   | 1000                           |
| φ 10  | 12  | 12  | 12  |   | 12  |   | 1000                           |
|   | 14  | 14  | 14  |   | 14  | HIT-VL<br>11/1,0  | 1000                           |
| φ 12  | 14  | 14  | 14  |   | 14  |   | 1000                           |
|   | 16  | 16  | 16  |   | 16  |   | 1200                           |
| φ 13  | 16  | 16  | 16  |   | 16  |   | 1300                           |
| φ 14  | 18  | 18  | 18  |   | 18  |   | 1400                           |
| φ 16  | 20  | 20  | 20  |   | HIT-DL 16/0,8<br>or<br>HIT-DL B<br>and/or<br>HIT-VL 16/0,7<br>and/or<br>HIT-VL 16   | HIT-VL<br>16/0,7<br>and/or<br>HIT-VL 16   | 1600                           |
| φ 18  | 22  | 22  | 22  |   |   |   | 22                             |
| φ 20  | 25  | 25  | 25  | 25  |   |   | 2000                           |
| φ 22  | 28  | 28  | 28  | 28  |   |   | 2200                           |
|   | 30  | 30  | 30  | 30  |   |   | 1000                           |
| φ 24  | 32  | 32  | 32  | 32  |   |   | 2400                           |
|   | 30  | 30  | 30  | 30  |   |   | 1000                           |
| φ 25  | 32  | 32  | 32  | 32  |   |   | 2500                           |
|   | 35  | 35  | 32  | 35  |   |   | 2800                           |
| φ 30  | 37  | 37  | 32  | 37  |   |   | 3000                           |
| φ 32  | 40  | 40  | 32  | 40  | 3200  |   |                                |
| φ 36  | 45  | 45  | 32  | 45  | 3200  |   |                                |
| φ 40  | 55  | 55  | 32  | 55  | 3200  |   |                                |

<sup>1)</sup> Assemble extension HIT-VL 16/0,7 with coupler HIT-VL K for deeper drill holes.

Injection system Hilti HIT-RE 500 V4







Annex B4

**Intended use**

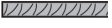
Parameters of drilling, cleaning and setting tools  
 Hammer drilling



**Table B5: Parameters of drilling, cleaning and setting tools, hammer drilling with Hilti hollow drill bit**

| Element   | Drill and clean   |   |   |   | Installation  |   |                          |
|---|---|---|---|---|---|---|--------------------------|
|   | Hammer drilling with Hilti hollow drill bit <sup>1)</sup>                         | Brush HIT-RB  | Air nozzle HIT-DL   | Extension for air nozzle  | Piston plug HIT-SZ  | Extension for piston plug   | Maximum embedment length |
|  |  |  |  |  |  |  | -                        |
| Size  | d <sub>0</sub> [mm]   | Size  | Size  | [-]   | Size  | [-]   | l <sub>b,max</sub> [mm]  |
| φ 8   | 10  | No cleaning required.   |   |   | -   | HIT-VL 9/1,0  | 250                      |
|   | 12  |   |   |   | 12  |   | 1000                     |
| φ 10  | 12  |   |   |   | 12  | 1000  |                          |
|   | 14  |   |   |   | 14  | 1000  |                          |
| φ 12  | 14  |   |   |   | HIT-VL 11/1,0   | 14  | 1000                     |
|   | 16  |   |   |   |   | 16  | 1000                     |
| φ 13  | 16  |   |   |   |   | 16  | 1000                     |
| φ 14  | 18  |   |   |   |   | 18  | 1000                     |
| φ 16  | 20  |   |   |   |   | 20  | 1000                     |
| φ 18  | 22  |   |   |   |   | 22  | 1000                     |
| φ 20  | 25  |   |   |   |   | 25  | 1000                     |
| φ 22  | 28  |   |   |   |   | 28  | 1000                     |
| φ 24  | 32  |   |   |   | HIT-VL 16/0,7 and/or HIT-VL 16  | 32  | 1000                     |
| φ 25  | 32  |   |   |   |   | 32  | 1000                     |
| φ 28  | 35  |   |   |   |   | 32  | 1000                     |

<sup>1)</sup> With vacuum cleaner Hilti VC 10/20/40 (automatic filter cleaning activated, eco-mode off) or vacuum cleaner providing equivalent cleaning performance in combination with the specified Hilti hollow drill bit TE-CD or TE-YD.  
<sup>2)</sup> Assemble extension HIT-VL 16/0,7 with coupler HIT-VL K for deeper drill holes.







Injection system Hilti HIT-RE 500 V4

Annex B5

**Intended use**

Parameters of drilling, cleaning and setting tools  
 Hammer drilling with Hilti hollow drill bit

**Table B6: Parameters of drilling, cleaning and setting tools diamond coring**

| Element   | Drill and clean   |   |   |   | Installation  |   |                           |
|---|---|---|---|---|---|---|---------------------------|
|   | Rebar   | Diamond coring (wet)  | Brush HIT-RB  | Air nozzle HIT-DL   | Extension for air nozzle  | Piston plug HIT-SZ  | Extension for piston plug |
|  |  |  |  |  |  |  | -                         |
| Size  | d <sub>0</sub> [mm]   | Size  | Size  | [-]   | Size  | [-]   | l <sub>b,max</sub> [mm]   |
| φ 8   | 10  | 10  | 10  | HIT-DL 10/0,8<br>or<br>HIT-DL V10/1   | -   | HIT-VL 9/1,0  | 250                       |
|   | 12  | 12  | 12  |   | 12  |   | 1000                      |
| φ 10  | 12  | 12  | 12  |   | 12  | HIT-VL 11/1,0   | 1000                      |
|   | 14  | 14  | 14  |   | 14  |   | 1000                      |
| φ 12  | 14  | 14  | 14  |   | 14  |   | 1000                      |
|   | 16  | 16  | 16  |   | 16  |   | 1200                      |
| φ 13  | 16  | 16  | 16  |   | 16  |   | 1300                      |
| φ 14  | 18  | 18  | 18  |   | 18  |   | 1400                      |
| φ 16  | 20  | 20  | 20  |   | 20  |   | 1600                      |
| φ 18  | 22  | 22  | 22  |   | 22  |   | 1800                      |
| φ 20  | 25  | 25  | 25  | 25  | 2000  |   |                           |
| φ 22  | 28  | 28  | 28  | HIT-DL 16/0,8<br>or<br>HIT-DL B<br>and/or<br>HIT-VL 16/0,7<br>and/or HIT-VL 16    | 28  | HIT-VL 16/0,7<br>and/or<br>HIT-VL 16  | 2200                      |
|   | 30  | 30  | 30  |   | 30  |   | 1000                      |
| φ 24  | 32  | 32  | 32  |   | 32  |   | 2400                      |
|   | 30  | 30  | 30  |   | 30  |   | 1000                      |
| φ 25  | 32  | 32  | 32  |   | 32  |   | 2500                      |
|   | 35  | 35  | 32  |   | 35  |   | 2800                      |
| φ 30  | 37  | 37  | 32  |   | 37  |   | 3000                      |
| φ 32  | 40  | 40  | 32  |   | 40  |   | 3200                      |

1) Assemble extension HIT-VL 16/0,7 with coupler HIT-VL K for deeper drill holes.







Injection system Hilti HIT-RE 500 V4

**Intended use**

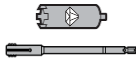
Parameters of drilling, cleaning and setting tools  
 Hammer drilling with Hilti hollow drill bit

**Annex B6**

**Table B7: Parameters of drilling, cleaning and setting tools, diamond coring with roughening**

| Element   | Drill and clean   |   |   |   | Installation  |   |                          |
|---|---|---|---|---|---|---|--------------------------|
|   | Diamond coring with roughening  | Brush HIT-RB  | Air nozzle HIT-DL   | Extension for air nozzle  | Piston plug HIT-SZ  | Extension for piston plug   | Maximum embedment length |
|  |  |  |  |  |  |  <sup>1)</sup> | -                        |
| Size  | d <sub>0</sub> [mm]   | Size  | Size  | [-]   | Size  | [-]   | l <sub>b,max</sub> [mm]  |
| φ 14  | 18  | 18  | 18  | HIT-DL 10/0,8<br>or<br>HIT-DL V10/1   | 18  | HIT-VL 11/1,0   | 900                      |
| φ 16  | 20  | 20  | 20  | HIT-DL 16/0,8<br>or<br>HIT-DL B<br>and/or<br>HIT-VL 16/0,7<br>and/or<br>HIT-VL 16 | 20  | HIT-VL 16/0,7<br>and/or<br>HIT-VL 16  | 1000                     |
| φ 18  | 22  | 22  | 22  |   | 22  |   | 1200                     |
| φ 20  | 25  | 25  | 25  |   | 25  |   | 1300                     |
| φ 22  | 28  | 28  | 28  |   | 28  |   | 1400                     |
| φ 24  | 30  | 30  | 30  |   | 30  |   | 1600                     |
|   | 32  | 32  | 32  |   | 32  |   | 1600                     |
| φ 25  | 30  | 30  | 30  |   | 30  |   | 1600                     |
|   | 32  | 32  | 32  |   | 32  |   | 1600                     |
| φ 28  | 35  | 35  | 32  | 35  | 1800  |   |                          |

<sup>1)</sup> Assemble extension HIT-VL 16/0,7 with coupler HIT-VL K for deeper drill holes.



Injection system Hilti HIT-RE 500 V4

**Intended use**



Parameters of drilling, cleaning and setting tools  
 Diamond coring with roughening

**Annex B7**

**Table B8: Cleaning alternatives for hammer drilling**

|   |  |
|---|--|
| <p><b>Automatic Cleaning (AC):</b><br/>                 Cleaning is performed during drilling with Hilti hollow drill bit TE-CD, TE-YD including vacuum cleaner.</p>    |  |
| <p><b>Compressed Air Cleaning (CAC):</b><br/>                 air nozzle with an orifice opening of minimum 3,5 mm in diameter.<br/>                 + brush HIT-RB</p> |  |

**Table B9: Parameters for use of the Hilti Roughening tool TE-YRT**

| Diamond coring  |               | Roughening tool TE-YRT   | Wear gauge RTG...   |
|---|---------------|--|---|
|  |               |  |  |
| $d_0$   |               |  |   |
| nominal [mm]  | measured [mm] | $d_0$ [mm]   | size  |
| 18  | 17,9 to 18,2  | 18   | 18  |
| 20  | 19,9 to 20,2  | 20   | 20  |
| 22  | 21,9 to 22,2  | 22   | 22  |
| 25  | 24,9 to 25,2  | 25   | 25  |
| 28  | 27,9 to 28,2  | 28   | 28  |
| 30  | 29,9 to 30,2  | 30   | 30  |
| 32  | 31,9 to 32,2  | 32   | 32  |
| 35  | 34,9 to 35,2  | 35   | 35  |

**Table B10: Installation parameters for use of the Hilti Roughening tool TE-YRT**

| $l_b$ [mm] | Roughening time $t_{roughen}$ ( $t_{roughen} [sec] = l_b [mm] / 10$ ) |
|------------|---|
| 0 to 100   | 10  |
| 101 to 200 | 20  |
| 201 to 300 | 30  |
| 301 to 400 | 40  |
| 401 to 500 | 50  |
| 501 to 600 | 60  |

**Table B11: Hilti Roughening tool TE-YRT and wear gauge RTG**

|        |  |
|--------|--|
| TE-YRT |  |
| RTG    |  |

Injection system Hilti HIT-RE 500 V4

**Intended use**

Cleaning alternatives / Parameters for use of Hilti Roughening tool

Annex B8

## Installation instruction

### Safety Regulations:



Review the Material Safety Data Sheet (MSDS) before use for proper and safe handling!  
 Wear well-fitting protective goggles and protective gloves when working with Hilti HIT-RE 500 V4.  
 Important: Observe the installation instruction provided with each foil pack.

### Hole drilling

Before drilling remove carbonized concrete and clean contact areas.  
 In case of aborted drill hole the drill hole shall be filled with mortar.

**a) Hammer drilling:** for dry or wet concrete and installation in water-filled drill holes (no sea water).

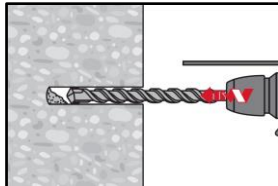

Drill hole to the required embedment length with a hammer drill set in rotation-hammer mode using an appropriately sized carbide drill bit.

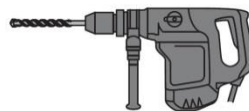

**b) Hammer drilling with Hilti hollow drill bit TE-CD, TE-YD:** for dry and wet concrete only.

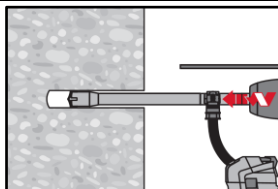

Drill hole to the required embedment length with an appropriately sized Hilti TE-CD or TE-YD hollow drill bit attached to Hilti vacuum cleaner VC 20/40/60 or a vacuum cleaner acc. to Table B5 with automatic filter cleaning activated. This drilling system removes the dust and cleans the drill hole during drilling when used in accordance with the user's manual. After drilling is completed, proceed to the "injection preparation" step in the installation instruction.

**c) Diamond coring:** for dry and wet concrete only.

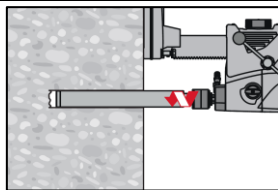

Diamond coring is permissible when suitable diamond core drilling machines and the corresponding core bits are used.

**d) Diamond coring with roughening with Hilti Roughening tool TE-YRT:** for dry and wet concrete only.

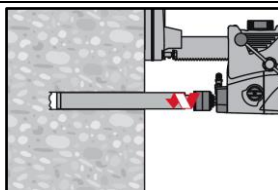

Diamond coring is permissible when suitable diamond core drilling machines and the corresponding core bits are used.

For the use in combination with Hilti Roughening tool TE-YRT see parameters in Table B9.

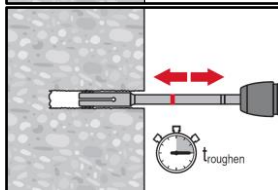

Before roughening water needs to be removed from the drillhole. Check usability of the roughening tool with the wear gauge RTG.  
 Roughen the drillhole over the whole length to the required  $l_b$ .

Injection system Hilti HIT-RE 500 V4

Annex B9

Product description.  
 Installation instruction

**Splicing applications**

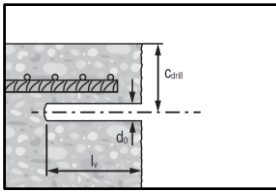

Measure and control concrete cover  $c$ .  
 $c_{\text{drill}} = c + d_0/2$ .  
 Drill parallel to surface edge and to existing rebar.  
 Where applicable use Hilti drilling aid HIT-BH.

**Drilling aid:** for drill holes depths > 20 cm use drilling aid.

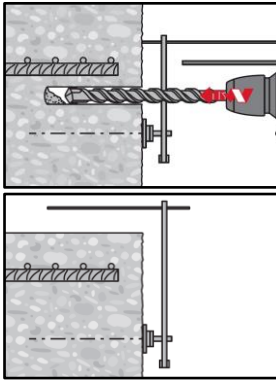

Ensure that the drill hole is parallel to the existing rebar.  
 Three different options can be considered:

- Hilti drilling aid HIT-BH
- Lath or spirit level
- Visual check

**Drill hole cleaning:** just before setting the bar the drill hole must be free of dust and debris.  
 Inadequate hole cleaning = poor load values.

**Compressed Air Cleaning (CAC)** for hammer drilled holes:  
 for  $\phi 8$  to  $\phi 12$  and drill holes depths  $\leq 250$  mm or for  $\phi > 12$  mm and drill holes depths  $\leq 20 \cdot \phi$ .

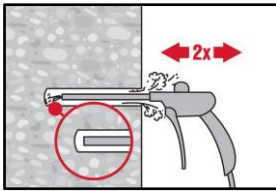

Blow 2 times from the back of the hole (if needed with nozzle extension) over the whole length with oil-free compressed air (min. 6 bar at 6 m<sup>3</sup>/h) until return air stream is free of noticeable dust.

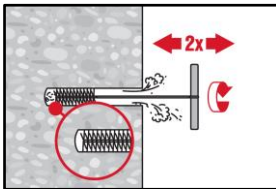

Brush 2 times with the specified brush (see Table B4) by inserting the steel brush Hilti HIT-RB to the back of the hole (if needed with extension) in a twisting motion and removing it.  
 The brush must produce natural resistance as it enters the drill hole (brush  $\phi \geq$  drill hole  $\phi$ ) - if not the brush is too small and must be replaced with the proper brush diameter.

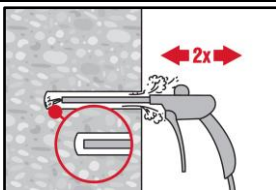

Blow again with compressed air 2 times until return air stream is free of noticeable dust.

**Injection system Hilti HIT-RE 500 V4**

**Product description.**  
 Installation instruction

**Annex B10**

**Compressed Air Cleaning (CAC) for hammer drilled holes:**

for  $\phi 8$  to  $\phi 12$  and drill holes depths  $> 250$  mm or for  $\phi > 12$  mm and drill holes depths  $> 20 \cdot \phi$ .

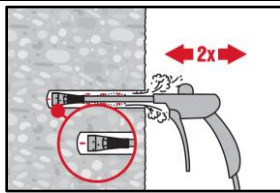

Use the appropriate air nozzle Hilti HIT-DL (see Table B4).  
 Blow 2 times from the back of the hole over the whole length with oil-free compressed air until return air stream is free of noticeable dust.  
 Safety tip:  
 Do not inhale concrete dust.

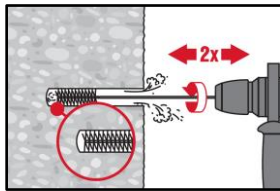

Screw the round steel brush HIT-RB in one end of the brush extension(s) HIT-RBS, so that the overall length of the brush is sufficient to reach the base of the drill hole. Attach the other end of the extension to the TE-C/TE-Y chuck.  
 Safety tip:  
 Start machine brushing operation slowly.  
 Start brushing operation once the brush is inserted in the drillhole.

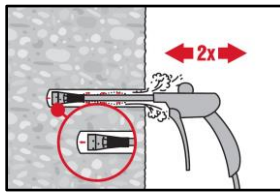

Use the appropriate air nozzle Hilti HIT-DL (see Table 4).  
 Blow 2 times from the back of the hole over the whole length with oil-free compressed air until return air stream is free of noticeable dust.  
 Safety tip:  
 Do not inhale concrete dust.

**Cleaning of hammer drilled water-filled drill holes and diamond cored holes:**

hammer drilled water-filled drill holes: for all drill hole diameters  $d_0$  and drill hole depths  $\leq 20 \phi$ ,  
 diamond cored holes: for all drill hole diameters  $d_0$  and all drill hole depths.

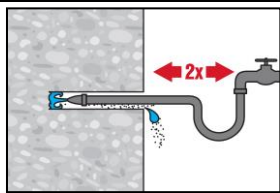

Flush 2 times by inserting a water hose (water-line pressure) to the back of the hole until water runs clear.

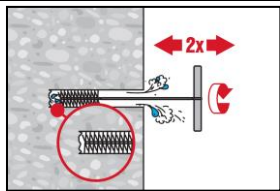

Brush 2 times with the specified brush (see Table B4 and Table B6) by inserting the steel brush Hilti HIT-RB to the back of the hole (if needed with extension) in a twisting motion and removing it.  
 The brush must produce natural resistance as it enters the drill hole (brush  $\phi \geq$  drill hole  $\phi$ ) - if not the brush is too small and must be replaced with the proper brush diameter.

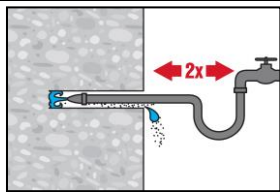

Flush 2 times by inserting a water hose (water-line pressure) to the back of the hole until water runs clear.

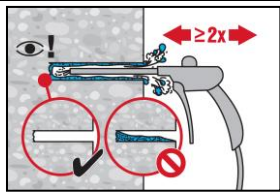

Blow 2 times from the back of the hole (if needed with nozzle extension) over the whole length with oil-free compressed air (min. 6 bar at 6 m<sup>3</sup>/h) until return air stream is free of noticeable dust and water.  
 For drill hole diameters  $\geq 32$  mm the compressor has to supply a minimum air flow of 140 m<sup>3</sup>/h.

Injection system Hilti HIT-RE 500 V4

Product description.  
 Installation instruction

Annex B11

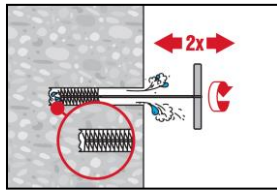

Brush 2 times with the specified brush size (see Table B4 and Table B6) by inserting the steel brush Hilti HIT-RB to the back of the hole (if needed with extension) in a twisting motion and removing it.  
 The brush must produce natural resistance as it enters the drill hole – if not the brush is too small and must be replaced with the proper brush diameter.

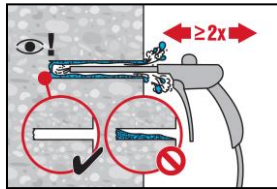

Blow again with compressed air 2 times until return air stream is free of noticeable dust and water.

**Cleaning of diamond cored holes with roughening with Hilti Roughening tool TE-YRT:**

for all drill hole diameters  $d_0$  and all drill hole depths.

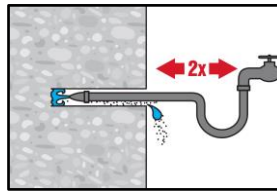

Flush 2 times by inserting a water hose (water-line pressure) to the back of the hole until water runs clear.

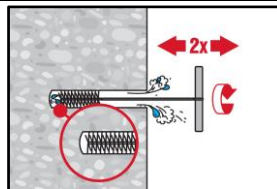

Brush 2 times with the specified brush (see Table B6) by inserting the steel brush Hilti HIT-RB to the back of the hole (if needed with extension) in a twisting motion and removing it.  
 The brush must produce natural resistance as it enters the drill hole (brush  $\varnothing \geq$  drill hole  $\varnothing$ ) - if not the brush is too small and must be replaced with the proper brush diameter.

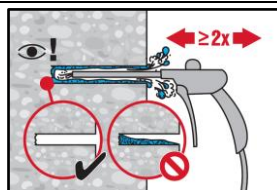

Blow 2 times from the back of the hole (if needed with nozzle extension) over the whole length with oil-free compressed air (min. 6 bar at 6 m<sup>3</sup>/h) until return air stream is free of noticeable dust and water.  
 For drill hole diameters  $\geq 32$  mm the compressor has to supply a minimum air flow of 140 m<sup>3</sup>/h.

**Rebar preparation**

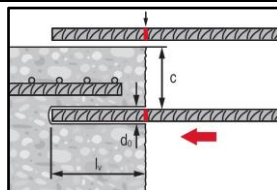

Before use, make sure the rebar is dry and free of oil or other residue.  
 Mark the embedment length on the rebar (e.g. with tape) →  $l_b$ .  
 Insert rebar in drillhole to verify hole and embedment length  $l_b$ .

**Injection preparation**

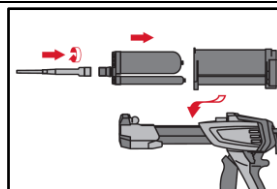

Tightly attach Hilti mixing nozzle HIT-RE-M to foil pack manifold. Do not modify the mixing nozzle.  
 Observe the instruction for use of the dispenser.  
 Check foil pack holder for proper function. Insert foil pack into foil pack holder and put holder into dispenser.

Injection system Hilti HIT-RE 500 V4

Annex B12

Product description.  
 Installation instruction



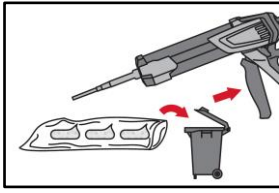

The foil pack opens automatically as dispensing is initiated. Depending on the size of the foil pack an initial amount of adhesive has to be discarded. Discarded quantities are:

- 3 strokes for 330 ml foil pack,
- 4 strokes for 500 ml foil pack,
- 65 ml for 1400 ml foil pack.

The minimum temperature of the foil pack is +5° C.

**Inject adhesive:** inject adhesive from the back of the drill hole without forming air voids.

**Injection method for drill hole depth ≤ 250 mm (without overhead applications)**

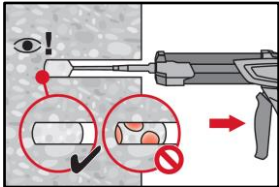

Inject the adhesive starting at the back of the hole, slowly withdrawing the mixer with each trigger pull.

Fill approximately 2/3 of the drill hole to ensure that the annular gap between the anchor and the concrete is completely filled with adhesive along the embedment length.

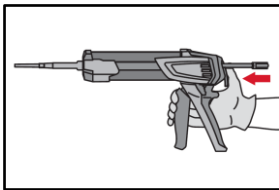

After injection is completed, depressurize the dispenser by pressing the release trigger. This will prevent further adhesive discharge from the mixer.

**Injection method for drill hole depth > 250 mm or overhead applications**

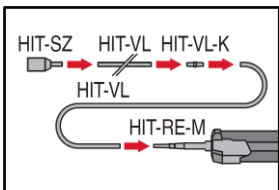

Assemble mixing nozzle HIT-RE-M, extension(s) and piston plug HIT-SZ (see Table B4 to Table B7).

For combinations of several injection extensions use coupler HIT-VL-K.

A substitution of the injection extension for a plastic hose or a combination of both is permitted.

The combination of HIT-SZ piston plug with HIT-VL 16 pipe and then HIT-VL 16 tube support proper injection.

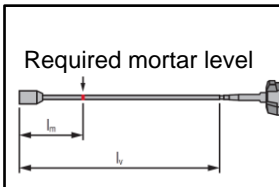

Mark the required mortar level  $l_m$  and embedment length  $l_b$  with tape or marker on the injection extension.

Estimation:  $l_m = 1/3 \cdot l_b$

Precise formula for optimum mortar volume:  $l_m = l_b \cdot (1,2 \cdot (\phi^2 / d_o^2) - 0,2)$

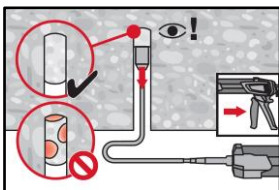

For overhead installation the injection is only possible with the aid of extensions and piston plugs. Assemble HIT-RE-M mixer, extension(s) and appropriately sized piston plug (see Table B4 to Table B7). Insert piston plug to back of the hole and inject adhesive. During injection the piston plug will be naturally extruded out of the drill hole by the adhesive pressure.

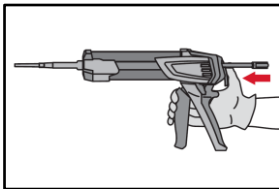

After injection is completed, depressurize the dispenser by pressing the release trigger. This will prevent further adhesive discharge from the mixer.

Injection system Hilti HIT-RE 500 V4

Annex B13

Product description.  
 Installation instruction

**Setting the element:** before use, verify that the element is dry and free of oil and other contaminants.

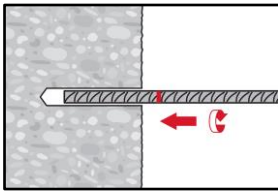

For easy installation insert the rebar into the drill hole while slowly twisting until the embedment mark is at the concrete surface level.

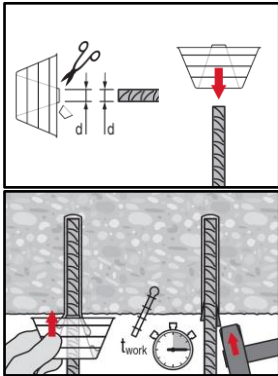

For overhead application:  
 During insertion of the rebar mortar might flow out of the drill hole. For collection of the flowing mortar HIT-OHC may be used.  
 Support the rebar and secure it from falling until mortar has started to harden, e.g. using wedges HIT-OHW.

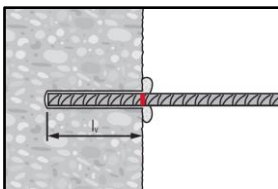

After installing the rebar the annular gap must be completely filled with mortar. Proper installation:

- desired anchoring embedment  $l_b$  is reached: embedment mark at concrete surface.
- excess mortar flows out of the drillhole after the rebar has been fully inserted until the embedment mark.

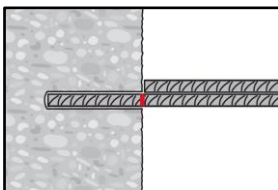

Observe the working time  $t_{work}$  (see Table B3), which varies according to temperature of base material. Minor adjustments to the rebar position may be performed during the working time.

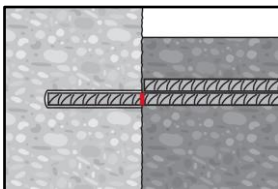

Full load may be applied only after the curing time  $t_{cure}$  has elapsed (see Table B3).

Injection system Hilti HIT-RE 500 V4

Product description.  
 Installation instruction

Annex B14

**Table C1: Essential characteristics for reinforcing bars (rebars) under tension load in concrete under static and quasi-static loading**

| Reinforcing bar (rebar)  |                 |      | φ8              | φ10 | φ12 | φ13 | φ14 | φ16 | φ18 | φ20 | φ22 | φ24 | φ25 | φ28 | φ30 | φ32 | φ36 | φ40 |
|--|-----------------|------|-----------------|-----|-----|-----|-----|-----|-----|-----|-----|-----|-----|-----|-----|-----|-----|-----|
| <b>Installation factor</b>                                       |                 |      |                 |     |     |     |     |     |     |     |     |     |     |     |     |     |     |     |
| Hammer drilling  | $\gamma_{inst}$ | [-]  | 1,0             |     |     |     |     |     |     |     |     |     |     |     |     |     | 1,2 |     |
| Hammer drilling with Hilti hollow drill bit TE-CD or TE-YD       | $\gamma_{inst}$ | [-]  | 1,0             |     |     |     |     |     |     |     |     |     |     |     |     |     | 1)  |     |
| Diamond coring   | $\gamma_{inst}$ | [-]  | 1,2             |     |     |     |     |     | 1,4 |     |     |     |     |     | 1)  |     |     |     |
| Diamond coring with roughening with Hilti Roughening tool TE-YRT | $\gamma_{inst}$ | [-]  | 1)              |     |     | 1,0 |     |     |     |     |     | 1)  |     |     |     |     |     |     |
| Hammer drilling in water-filled drill holes                      | $\gamma_{inst}$ | [-]  | 1,4             |     |     |     |     |     |     |     |     |     |     |     |     |     | 1)  |     |
| <b>Concrete cone failure</b>                                     |                 |      |                 |     |     |     |     |     |     |     |     |     |     |     |     |     |     |     |
| Factor for cracked concrete                                      | $k_{cr,N}$      | [-]  | 7,7             |     |     |     |     |     |     |     |     |     |     |     |     |     |     |     |
| Factor for uncracked concrete                                    | $k_{ucr,N}$     | [-]  | 11,0            |     |     |     |     |     |     |     |     |     |     |     |     |     |     |     |
| Edge distance  | $c_{cr,N}$      | [mm] | $1,5 \cdot l_b$ |     |     |     |     |     |     |     |     |     |     |     |     |     |     |     |
| Spacing  | $s_{cr,N}$      | [mm] | $3,0 \cdot l_b$ |     |     |     |     |     |     |     |     |     |     |     |     |     |     |     |

Injection system Hilti HIT-RE 500 V4

Annex C1

**Performance**

Essential characteristics under static and quasi-static loading

**Table C1: continued (1)**

| Reinforcing bar (rebar)   | φ8              | φ10                  | φ12                 | φ13 | φ14 | φ16 | φ18 | φ20 | φ22 | φ24 | φ25 | φ28 | φ30 | φ32 | φ36 | φ40 |     |    |
|---|-----------------|----------------------|---------------------|-----|-----|-----|-----|-----|-----|-----|-----|-----|-----|-----|-----|-----|-----|----|
| <b>Combined pullout and concrete cone failure for working life of 50 years</b>  |                 |                      |                     |     |     |     |     |     |     |     |     |     |     |     |     |     |     |    |
| Characteristic resistance in uncracked concrete C20/25<br>in <b>hammer drilled holes</b> and <b>hammer drilled holes with Hilti hollow drill bit TE-CD or TE-YD</b><br>and <b>diamond cored holes with roughening with Hilti Roughening tool TE-YRT</b> |                 |                      |                     |     |     |     |     |     |     |     |     |     |     |     |     |     |     |    |
| Temperature range I: 40°C / 24°C  | $\tau_{RK,ucr}$ | [N/mm <sup>2</sup> ] | 10                  | 15  | 15  | 15  | 15  | 15  | 14  | 14  | 14  | 14  | 14  | 14  | 13  | 13  | 12  | 11 |
| Temperature range II: 55°C / 43°C   | $\tau_{RK,ucr}$ | [N/mm <sup>2</sup> ] | 8,5                 | 13  | 12  | 12  | 12  | 12  | 12  | 12  | 12  | 11  | 11  | 11  | 11  | 9,5 | 9,5 |    |
| Temperature range III: 75°C / 55°C  | $\tau_{RK,ucr}$ | [N/mm <sup>2</sup> ] | 3,5                 | 5,0 | 5,0 | 4,5 | 4,5 | 4,5 | 4,5 | 4,5 | 4,5 | 4,5 | 4,5 | 4,5 | 4,5 | 4,0 | 3,5 |    |
| Characteristic resistance in uncracked concrete C20/25<br>in <b>diamond cored holes</b>   |                 |                      |                     |     |     |     |     |     |     |     |     |     |     |     |     |     |     |    |
| Temperature range I: 40°C / 24°C  | $\tau_{RK,ucr}$ | [N/mm <sup>2</sup> ] | 9,5                 | 9,5 | 9,5 | 9,5 | 9,5 | 9,5 | 9,5 | 9,5 | 9,5 | 9,5 | 10  | 10  | 10  |     |     |    |
| Temperature range II: 55°C / 43°C   | $\tau_{RK,ucr}$ | [N/mm <sup>2</sup> ] | 8,5                 | 8,5 | 8,5 | 8,5 | 8,5 | 8,5 | 8,5 | 8,5 | 8,5 | 8,5 | 8,5 | 9,0 | 9,0 |     |     | 1) |
| Temperature range III: 75°C / 55°C  | $\tau_{RK,ucr}$ | [N/mm <sup>2</sup> ] | 4,0                 | 4,0 | 4,0 | 4,0 | 4,0 | 4,0 | 4,0 | 4,0 | 4,5 | 4,5 | 4,5 | 4,5 | 4,5 |     |     |    |
| Characteristic resistance in uncracked concrete C20/25<br>in <b>hammer drilled holes and installation in water-filled drill holes</b>   |                 |                      |                     |     |     |     |     |     |     |     |     |     |     |     |     |     |     |    |
| Temperature range I: 40°C / 24°C  | $\tau_{RK,ucr}$ | [N/mm <sup>2</sup> ] | 8,5                 | 13  | 13  | 13  | 13  | 12  | 12  | 12  | 12  | 12  | 12  | 11  | 11  |     |     |    |
| Temperature range II: 55°C / 43°C   | $\tau_{RK,ucr}$ | [N/mm <sup>2</sup> ] | 7,0                 | 11  | 11  | 10  | 10  | 10  | 10  | 10  | 10  | 10  | 9,5 | 9,5 | 9,5 |     |     | 1) |
| Temperature range III: 75°C / 55°C  | $\tau_{RK,ucr}$ | [N/mm <sup>2</sup> ] | 3,0                 | 4,0 | 4,0 | 4,0 | 4,0 | 4,0 | 4,0 | 4,0 | 4,0 | 4,0 | 3,5 | 3,5 | 3,5 |     |     |    |
| <b>Influence factor <math>\psi</math> on bond resistance <math>\tau_{RK}</math> in cracked and uncracked concrete</b>   |                 |                      |                     |     |     |     |     |     |     |     |     |     |     |     |     |     |     |    |
| Influence of concrete strength  |                 |                      |                     |     |     |     |     |     |     |     |     |     |     |     |     |     |     |    |
| in <b>hammer drilled holes</b> and <b>hammer drilled holes with Hilti hollow drill bit TE-CD or TE-YD</b><br>and <b>diamond cored holes</b>   |                 |                      |                     |     |     |     |     |     |     |     |     |     |     |     |     |     |     |    |
| Temperature range I to III:   | $\psi_c$        | [-]                  | $(f_{ck}/20)^{0,1}$ |     |     |     |     |     |     |     |     |     |     |     |     |     |     |    |
| in <b>diamond cored holes with roughening with Hilti Roughening tool TE-YRT</b>   |                 |                      |                     |     |     |     |     |     |     |     |     |     |     |     |     |     |     |    |
| Temperature range I to III:   | $\psi_c$        | [-]                  | 1)                  |     |     |     | 1,0 |     |     |     |     |     | 1)  |     |     |     |     |    |
| Influence of sustained load   |                 |                      |                     |     |     |     |     |     |     |     |     |     |     |     |     |     |     |    |
| in <b>hammer drilled holes</b> and <b>hammer drilled holes with Hilti hollow drill bit TE-CD or TE-YD</b><br>and <b>diamond cored holes with roughening with Hilti Roughening tool TE-YRT</b>   |                 |                      |                     |     |     |     |     |     |     |     |     |     |     |     |     |     |     |    |
| Temperature range I: 40°C / 24°C  | $\psi_{sus}^0$  | [-]                  | 0,88                |     |     |     |     |     |     |     |     |     |     |     |     |     |     |    |
| Temperature range II: 55°C / 43°C   | $\psi_{sus}^0$  | [-]                  | 0,72                |     |     |     |     |     |     |     |     |     |     |     |     |     |     |    |
| Temperature range III: 75°C / 55°C  | $\psi_{sus}^0$  | [-]                  | 0,69                |     |     |     |     |     |     |     |     |     |     |     |     |     |     |    |
| in <b>diamond cored holes</b>   |                 |                      |                     |     |     |     |     |     |     |     |     |     |     |     |     |     |     |    |
| Temperature range I: 40°C / 24°C  | $\psi_{sus}^0$  | [-]                  | 0,89                |     |     |     |     |     |     |     |     |     |     |     |     |     |     |    |
| Temperature range II: 55°C / 43°C   | $\psi_{sus}^0$  | [-]                  | 0,70                |     |     |     |     |     |     |     |     |     |     |     |     |     |     |    |
| Temperature range III: 75°C / 55°C  | $\psi_{sus}^0$  | [-]                  | 0,62                |     |     |     |     |     |     |     |     |     |     |     |     |     |     |    |

**Injection system Hilti HIT-RE 500 V4**

**Annex C2**

**Performance**

Essential characteristics under static and quasi-static loading

**Table C1: continued (2)**

| Reinforcing bar (rebar)   | φ8       | φ10                     | φ12 | φ13 | φ14 | φ16 | φ18 | φ20 | φ22 | φ24 | φ25 | φ28 | φ30 | φ32 | φ36 | φ40 |
|---|----------|-------------------------|-----|-----|-----|-----|-----|-----|-----|-----|-----|-----|-----|-----|-----|-----|
| <b>Combined pullout and concrete cone failure for working life of 100 years</b>   |          |                         |     |     |     |     |     |     |     |     |     |     |     |     |     |     |
| Characteristic resistance in uncracked concrete C20/25<br>in <b>hammer drilled holes</b> and <b>hammer drilled holes with Hilti hollow drill bit TE-CD or TE-YD</b><br>and <b>diamond cored holes with roughening with Hilti Roughening tool TE-YRT</b> |          |                         |     |     |     |     |     |     |     |     |     |     |     |     |     |     |
| Temperature range I: 40°C / 24°C $\tau_{RK,100,ucr}$ [N/mm <sup>2</sup> ]   | 10       | 15                      | 15  | 15  | 15  | 15  | 14  | 14  | 14  | 14  | 14  | 14  | 13  | 13  | 12  | 11  |
| Temperature range II: 55°C / 43°C $\tau_{RK,100,ucr}$ [N/mm <sup>2</sup> ]  | 8,0      | 12                      | 12  | 12  | 12  | 12  | 12  | 12  | 11  | 11  | 11  | 11  | 11  | 11  | 9,5 | 9,5 |
| Temperature range III: 75°C / 55°C $\tau_{RK,100,ucr}$ [N/mm <sup>2</sup> ]   | 3,5      | 5,0                     | 5,0 | 4,5 | 4,5 | 4,5 | 4,5 | 4,5 | 4,5 | 4,5 | 4,5 | 4,5 | 4,5 | 4,5 | 4,0 | 3,5 |
| Characteristic resistance in uncracked concrete C20/25<br>in <b>diamond cored holes</b>   |          |                         |     |     |     |     |     |     |     |     |     |     |     |     |     |     |
| Temperature range I: 40°C / 24°C $\tau_{RK,100,ucr}$ [N/mm <sup>2</sup> ]   | 9,5      | 9,5                     | 9,5 | 9,5 | 9,5 | 9,5 | 9,5 | 9,5 | 9,5 | 9,5 | 9,5 | 10  | 10  | 10  | 1)  |     |
| Temperature range II: 55°C / 43°C $\tau_{RK,100,ucr}$ [N/mm <sup>2</sup> ]  | 8,5      | 8,5                     | 8,5 | 8,5 | 8,5 | 8,5 | 8,5 | 8,5 | 8,5 | 8,5 | 8,5 | 8,5 | 9,0 | 9,0 |     |     |
| Temperature range III: 75°C / 55°C $\tau_{RK,100,ucr}$ [N/mm <sup>2</sup> ]   | 4,0      | 4,0                     | 4,0 | 4,0 | 4,0 | 4,0 | 4,0 | 4,0 | 4,0 | 4,5 | 4,5 | 4,5 | 4,5 | 4,5 |     |     |
| Characteristic resistance in uncracked concrete C20/25<br>in <b>hammer drilled holes and installation in water-filled drill holes</b>   |          |                         |     |     |     |     |     |     |     |     |     |     |     |     |     |     |
| Temperature range I: 40°C / 24°C $\tau_{RK,100,ucr}$ [N/mm <sup>2</sup> ]   | 8,5      | 13                      | 13  | 13  | 13  | 12  | 12  | 12  | 12  | 12  | 12  | 12  | 11  | 11  | 1)  |     |
| Temperature range II: 55°C / 43°C $\tau_{RK,100,ucr}$ [N/mm <sup>2</sup> ]  | 7,0      | 11                      | 10  | 10  | 10  | 10  | 10  | 10  | 10  | 9,5 | 9,5 | 9,5 | 9,5 | 9,0 |     |     |
| Temperature range III: 75°C / 55°C $\tau_{RK,100,ucr}$ [N/mm <sup>2</sup> ]   | 3,0      | 4,0                     | 4,0 | 4,0 | 4,0 | 4,0 | 4,0 | 4,0 | 4,0 | 4,0 | 4,0 | 3,5 | 3,5 | 3,5 |     |     |
| <b>Influence factor <math>\psi</math> on bond resistance <math>\tau_{RK,100}</math> in cracked and uncracked concrete</b>   |          |                         |     |     |     |     |     |     |     |     |     |     |     |     |     |     |
| Influence of concrete strength  |          |                         |     |     |     |     |     |     |     |     |     |     |     |     |     |     |
| in <b>hammer drilled holes</b> and <b>hammer drilled holes with Hilti hollow drill bit TE-CD or TE-YD</b><br>and <b>diamond cored holes</b>   |          |                         |     |     |     |     |     |     |     |     |     |     |     |     |     |     |
| Temperature range I to III:   | $\psi_c$ | [-] $(f_{ck}/20)^{0,1}$ |     |     |     |     |     |     |     |     |     |     |     |     |     |     |
| in <b>diamond cored holes with roughening with Hilti Roughening tool TE-YRT</b>   |          |                         |     |     |     |     |     |     |     |     |     |     |     |     |     |     |
| Temperature range I to III:   | $\psi_c$ | [-] 1)                  |     |     |     |     | 1,0 |     |     |     |     | 1)  |     |     |     |     |
| Influence of sustained load   |          |                         |     |     |     |     |     |     |     |     |     |     |     |     |     |     |
| in <b>hammer drilled holes</b> and <b>hammer drilled holes with Hilti hollow drill bit TE-CD or TE-YD</b><br>and <b>diamond cored holes with roughening with Hilti Roughening tool TE-YRT</b>   |          |                         |     |     |     |     |     |     |     |     |     |     |     |     |     |     |
| Temperature range I: 40°C / 24°C $\psi_{sus,100}^0$   | [-] 0,85 |                         |     |     |     |     |     |     |     |     |     |     |     |     |     |     |
| Temperature range II: 55°C / 43°C $\psi_{sus,100}^0$  | [-] 0,72 |                         |     |     |     |     |     |     |     |     |     |     |     |     |     |     |
| Temperature range III: 75°C / 55°C $\psi_{sus,100}^0$   | [-] 0,69 |                         |     |     |     |     |     |     |     |     |     |     |     |     |     |     |
| in <b>diamond cored holes</b>   |          |                         |     |     |     |     |     |     |     |     |     |     |     |     |     |     |
| Temperature range I: 40°C / 24°C $\psi_{sus,100}^0$   | [-] 0,70 |                         |     |     |     |     |     |     |     |     |     |     |     |     |     |     |
| Temperature range II: 55°C / 43°C $\psi_{sus,100}^0$  | [-] 0,67 |                         |     |     |     |     |     |     |     |     |     |     |     |     |     |     |
| Temperature range III: 75°C / 55°C $\psi_{sus,100}^0$   | [-] 0,62 |                         |     |     |     |     |     |     |     |     |     |     |     |     |     |     |

**Injection system Hilti HIT-RE 500 V4**

**Annex C3**

**Performance**

Essential characteristics under static and quasi-static loading

**Table C1: continued (3)**

| Reinforcing bar (rebar)   |                    |     | φ8   | φ10  | φ12  | φ13  | φ14  | φ16  | φ18  | φ20  | φ22  | φ24  | φ25  | φ28  | φ30  | φ32  | φ36  | φ40  |      |    |
|---|--------------------|-----|------|------|------|------|------|------|------|------|------|------|------|------|------|------|------|------|------|----|
| <b>Bond-splitting failure for working life of 50 and 100 years</b>  |                    |     |      |      |      |      |      |      |      |      |      |      |      |      |      |      |      |      |      |    |
| in hammer drilled holes and hammer drilled holes with Hilti hollow drill bit TE-CD or TE-YD and diamond cored holes with roughening with Hilti Roughening tool TE-YRT |                    |     |      |      |      |      |      |      |      |      |      |      |      |      |      |      |      |      |      |    |
| Product basic factor  | A <sub>k</sub>     | [-] |      |      |      |      |      |      |      |      |      |      |      |      |      |      |      |      | 4,4  |    |
| Exponent for influence of concrete compressive strength   | sp1                | [-] |      |      |      |      |      |      |      |      |      |      |      |      |      |      |      |      | 0,29 |    |
| Exponent for influence of rebar diameter φ  | sp2                | [-] |      |      |      |      |      |      |      |      |      |      |      |      |      |      |      |      | 0,27 |    |
| Exponent for influence of concrete cover c <sub>d</sub>   | sp3                | [-] |      |      |      |      |      |      |      |      |      |      |      |      |      |      |      |      | 0,68 |    |
| Exponent for influence of side concrete cover (C <sub>max</sub> / C <sub>d</sub> )  | sp4                | [-] |      |      |      |      |      |      |      |      |      |      |      |      |      |      |      |      | 0,35 |    |
| Exponent for influence of anchorage length l <sub>b</sub>   | lb1                | [-] |      |      |      |      |      |      |      |      |      |      |      |      |      |      |      |      | 0,60 |    |
| <b>in diamond cored holes</b>   |                    |     |      |      |      |      |      |      |      |      |      |      |      |      |      |      |      |      |      |    |
| Product basic factor  | A <sub>k</sub>     | [-] |      |      |      |      |      |      |      |      |      |      |      |      |      |      |      |      | 4,4  | 1) |
| Exponent for influence of concrete compressive strength   | sp1                | [-] |      |      |      |      |      |      |      |      |      |      |      |      |      |      |      |      | 0,26 |    |
| Exponent for influence of rebar diameter φ  | sp2                | [-] |      |      |      |      |      |      |      |      |      |      |      |      |      |      |      |      | 0,25 |    |
| Exponent for influence of concrete cover c <sub>d</sub>   | sp3                | [-] |      |      |      |      |      |      |      |      |      |      |      |      |      |      |      |      | 0,52 |    |
| Exponent for influence of side concrete cover (C <sub>max</sub> / C <sub>d</sub> )  | sp4                | [-] |      |      |      |      |      |      |      |      |      |      |      |      |      |      |      |      | 0,26 |    |
| Exponent for influence of anchorage length l <sub>b</sub>   | lb1                | [-] |      |      |      |      |      |      |      |      |      |      |      |      |      |      |      |      | 0,65 |    |
| <b>Influence of cracked concrete on bond resistance τ<sub>rk</sub> for working life of 50 and 100 years</b>   |                    |     |      |      |      |      |      |      |      |      |      |      |      |      |      |      |      |      |      |    |
| in hammer drilled holes and hammer drilled holes with Hilti hollow drill bit TE-CD or TE-YD and diamond cored holes with roughening with Hilti Roughening tool TE-YRT |                    |     |      |      |      |      |      |      |      |      |      |      |      |      |      |      |      |      |      |    |
| Factor for influence of cracked concrete  | Ω <sub>cr,03</sub> | [-] | 1,00 | 0,96 | 0,90 | 0,88 | 0,85 | 0,82 | 0,78 | 0,76 | 0,73 | 0,71 | 0,70 | 0,68 | 0,66 | 0,65 | 0,62 | 0,60 |      |    |
| <b>in diamond cored holes</b>   |                    |     |      |      |      |      |      |      |      |      |      |      |      |      |      |      |      |      |      |    |
| Factor for influence of cracked concrete  | Ω <sub>cr,03</sub> | [-] |      |      |      |      |      |      |      |      |      |      |      |      |      |      |      |      | 0,5  | 1) |

1) No performance assessed.

**Injection system Hilti HIT-RE 500 V4**

**Annex C4**

**Performance**

Essential characteristics under static and quasi-static loading

**Table C2: Essential characteristics for reinforcing bars (rebars) under tension load in concrete under seismic action**

| Reinforcing bar (rebar)   | φ8               | φ10 | φ12  | φ13  | φ14  | φ16  | φ18  | φ20  | φ22  | φ24  | φ25  | φ28  | φ30  | φ32  | φ36  | φ40  |      |
|---|------------------|-----|------|------|------|------|------|------|------|------|------|------|------|------|------|------|------|
| <b>Pull-out failure for working life of 50 and 100 years</b>  |                  |     |      |      |      |      |      |      |      |      |      |      |      |      |      |      |      |
| in hammer drilled holes and hammer drilled holes with Hilti hollow drill bit TE-CD or TE-YD                         |                  |     |      |      |      |      |      |      |      |      |      |      |      |      |      |      |      |
| Reduction factor for pull-out resistance under seismic action   | $\alpha_{eq,p}$  | [-] | 0,61 | 0,83 |      |      |      |      |      |      |      |      |      |      |      | 0,65 |      |
| <b>Influence of cracked concrete on bond resistance <math>\tau_{Rk}</math> for working life of 50 and 100 years</b> |                  |     |      |      |      |      |      |      |      |      |      |      |      |      |      |      |      |
| in hammer drilled holes and hammer drilled holes with Hilti hollow drill bit TE-CD or TE-YD                         |                  |     |      |      |      |      |      |      |      |      |      |      |      |      |      |      |      |
| Factor for influence of cracked concrete  | $\Omega_{cr,05}$ | [-] | 0,79 | 0,81 | 0,82 | 0,83 | 0,84 | 0,82 | 0,78 | 0,76 | 0,73 | 0,71 | 0,70 | 0,68 | 0,66 | 0,65 | 0,60 |
|   | $\Omega_{cr,08}$ | [-] | 0,59 | 0,61 | 0,63 | 0,64 | 0,65 | 0,67 | 0,69 | 0,71 | 0,72 | 0,71 | 0,70 | 0,68 | 0,66 | 0,65 | 0,60 |
| <b>Bond-splitting failure for working life of 50 and 100 years</b>  |                  |     |      |      |      |      |      |      |      |      |      |      |      |      |      |      |      |
| in hammer drilled holes and hammer drilled holes with Hilti hollow drill bit TE-CD or TE-YD                         |                  |     |      |      |      |      |      |      |      |      |      |      |      |      |      |      |      |
| Reduction factor for bond-splitting resistance under seismic action   | $\alpha_{eq,sp}$ | [-] | 0,95 |      |      |      |      |      |      |      |      |      |      |      |      |      |      |

Injection system Hilti HIT-RE 500 V4

Annex C5

**Performance**

Essential characteristics under seismic action